

6" LED Light Engine with Drop Glass Trim

The perfect lighting solution for high-end residential and light commercial projects.



Features

- High efficacy LED module.
- Triac/ELV/0-10V dimming.
- Life span of 50,000 hours L70.
- USA designed and assembled.
- Limited 5 year warranty.
- 2 at the end of the item number denotes Generation 2.
Please note Gen 2 and Gen 1 are not cross compatible.

Specifications

Wattage	8.76W
Lumens	850 lm
Color Temp.	2700K
Lamp Type	LED
Beam Angle	60°
CRI	93+
Damp Location	Listed

Options



All White



Haze w/White ring



Gold w/White ring



Chrome w/White ring



All Bronze



Black w/White ring

Technical Details

Optics: Frosted polycarbonate module lens diffuses light evenly throughout while reducing glare with LED technology.

Trim Construction: Reflector is two piece trim for maximum color versatility. Design allows for minimal glare and a strong glare cut-off. Trim is constructed of metal for lasting durability.

Installation: Must be installed on a Cedar™ System frame with compatible lumen rating. Frames are available for New Construction and Remodel as IC or non-IC.

LED Technology:

- Extremely accurate Color Rendering Index of 93+.
- Efficacy of 97 lumens per watt.
- Lumen Maintenance of 50,000 hours L70 Life based on LM80 standardized test results.
- Superior Thermal Management by utilizing ELCO Red heat sink.
- Instant On to Full Brightness technology.
- No LED pixelation.

Listings:

- UL Listed for Wet Location.
- RoHS Compliant.
- California Title 24 (JA8-2016-E).

Dimensions

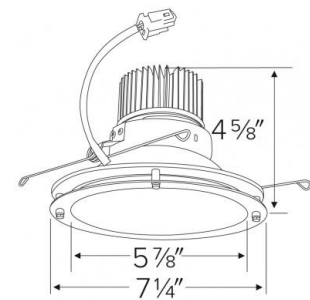

Product Number Builder Example: E612C0827W2

ELCO 6" Drop Glass	Lumens	Color Temp.	Finish	Generation
E612C	08 850 lm 12 1250 lm 16 1600 lm	27 2700K 30 3000K 35 3500K	W All White BZ All Bronze B Black w/White Ring	Gen 1 2 Gen 2

LED Light Engine

Multiplier: 2700K (x 0.96), 3500K (x 1.04), 4000K (x 1.08)

PHOTOMETRIC REPORT

Product #: E612C1230
Wattage/Lumens: 15.7W/ 1076 Lm
Luminaire LPW: 69 Lm/W

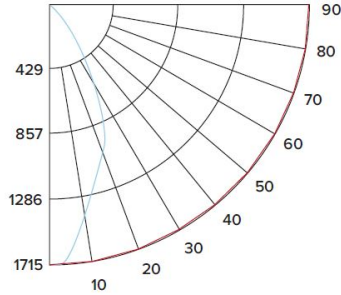

CANDLE POWER SUMMARY

Degrees Vertical	0°
0	1715
5	1614
15	1099
25	864
35	322
45	24
55	1
65	1
75	0
85	0
90	0

ILLUMINANCE AT A DISTANCE

Distance to Target Plane	Footcandles Beam Center	Beam Diameter
4'	107	3.8'
6'	47.6	5.6'
8'	26.8	7.5'
10'	17.1	9.4'

ZONAL LUMEN SUMMARY

Zone	Lumens	% Luminaire
0-30°	839.73	78.00
0-40°	1048.35	97.40
0-60°	1075.43	99.90
0-90°	1076.31	100.00

LED Light Engine

Multiplier: 2700K (x 0.96), 3500 (x 1.04), 4000K (x 1.08)

PHOTOMETRIC REPORT

Product #: E612C2030
Wattage/Lumens: 21.6W/ 1751 Lm
Luminaire LPW: 81 Lm/W

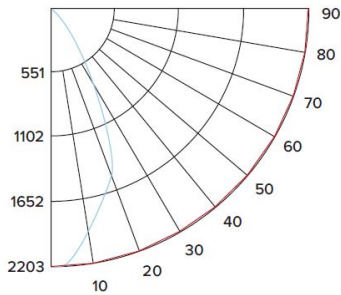

CANDLE POWER SUMMARY

Degrees Vertical	0°
0	2203
5	2155
15	1746
25	1401
35	597
45	55
55	2
65	1
75	0
85	0
90	0

ILLUMINANCE AT A DISTANCE

Distance to Target Plane	Footcandles Beam Center	Beam Diameter
4'	138	4.5'
6'	61.2	6.8'
8'	34.4	9.1'
10'	22.0	11.3'

ZONAL LUMEN SUMMARY

Zone	Lumens	% Luminaire
0-30°	1313.28	75.00
0-40°	1689.32	96.50
0-60°	1749.93	99.90
0-90°	1751.25	100.00

Compatible Products

For use with 6" Cedar™ Light Engines

6" Cedar™ Dedicated LED ICA Housings



2-Hour Fire Rated
6" ICA Housing
New Construction



6" ICA Housing
New Construction

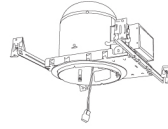

6" ICA Housing
New Construction

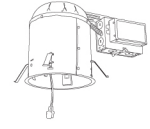

6" ICA Housing
Remodel

CAT NO.	SPECIFICATIONS	CAT NO.	SPECIFICATIONS	CAT NO.	SPECIFICATIONS	CAT NO.	SPECIFICATIONS
E6FH	Up to 1250lm	E6LC	Up to 2000lm	E6LC	Up to 1250lm	E6LRC	Up to 1250lm

6" Cedar™ Dedicated LED Non-IC Housings

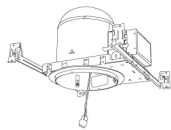

6" Non-IC Housing
New Construction

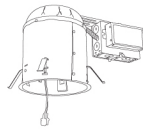

6" Non-IC Housing
Remodel

CAT NO.	SPECIFICATIONS	CAT NO.	SPECIFICATIONS
E6LC	Up to 2000lm	E6LRC	Up to 2000lm

PRODUCT NUMBER BUILDER

Housing Type	Lumen	ICA Airtight	Dimming	Optional
<input type="text"/>	<input type="text"/>	<input type="text"/>	<input type="text"/>	<input type="text"/>
E6FH Fire Rated	08 850 lm	(Blank) Non-IC	(Blank) 120V Triac/ELV	EM1 Emergency Backup up to 700 lm output
E6LC New Construction	12 1250 lm	ICA IC Airtight	D 120/277V Triac/ELV/0-10V	EM2 Emergency Backup up to 1100 lm output
E6LRC Remodel	16 1600 lm		L Lutron	
	20 2000 lm			