

Recessed Lighting



The
TeakTM
System

2" LED Downlights & Adjustables

EL **ELCO Lighting**
The Best Choice in Lighting



The Teak™ System

The Teak™ System is the perfect recessed residential downlight system featuring cutting-edge energy-efficient technology and design at an affordable price. These modules have a 2" aperture with lumen outputs that range from 800-1100 lumens. The Teak™ light engines allows for optional field changeable lenses making them the perfect fit for any room design. The quality driver built on top of the module allows for simple product maintenance and updates, and its auto release clips for easy installation.



Precise Beam Angle Control

Using industry leading technology ELCO offers the Teak™ LED Module with standard 38° beam angle, with field changeable 28° and 60° lens options to give designers and architects choices when laying out a room, whether the downlight is spot lighting a breakfast table or lighting up a bedroom ELCO has the necessary beam angle options.

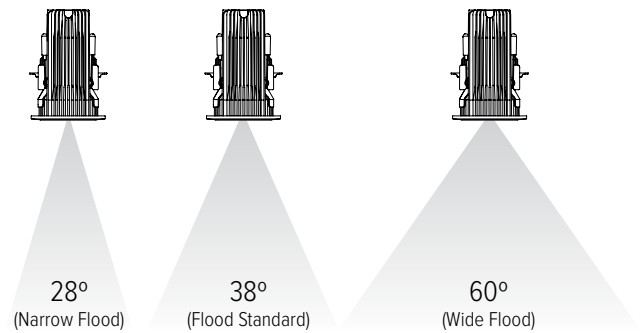

Easy Installation Clip!

All Teak™ LED Light Engines feature a patented trigger release clip that will depress as the module is being inserted, holding the module in place









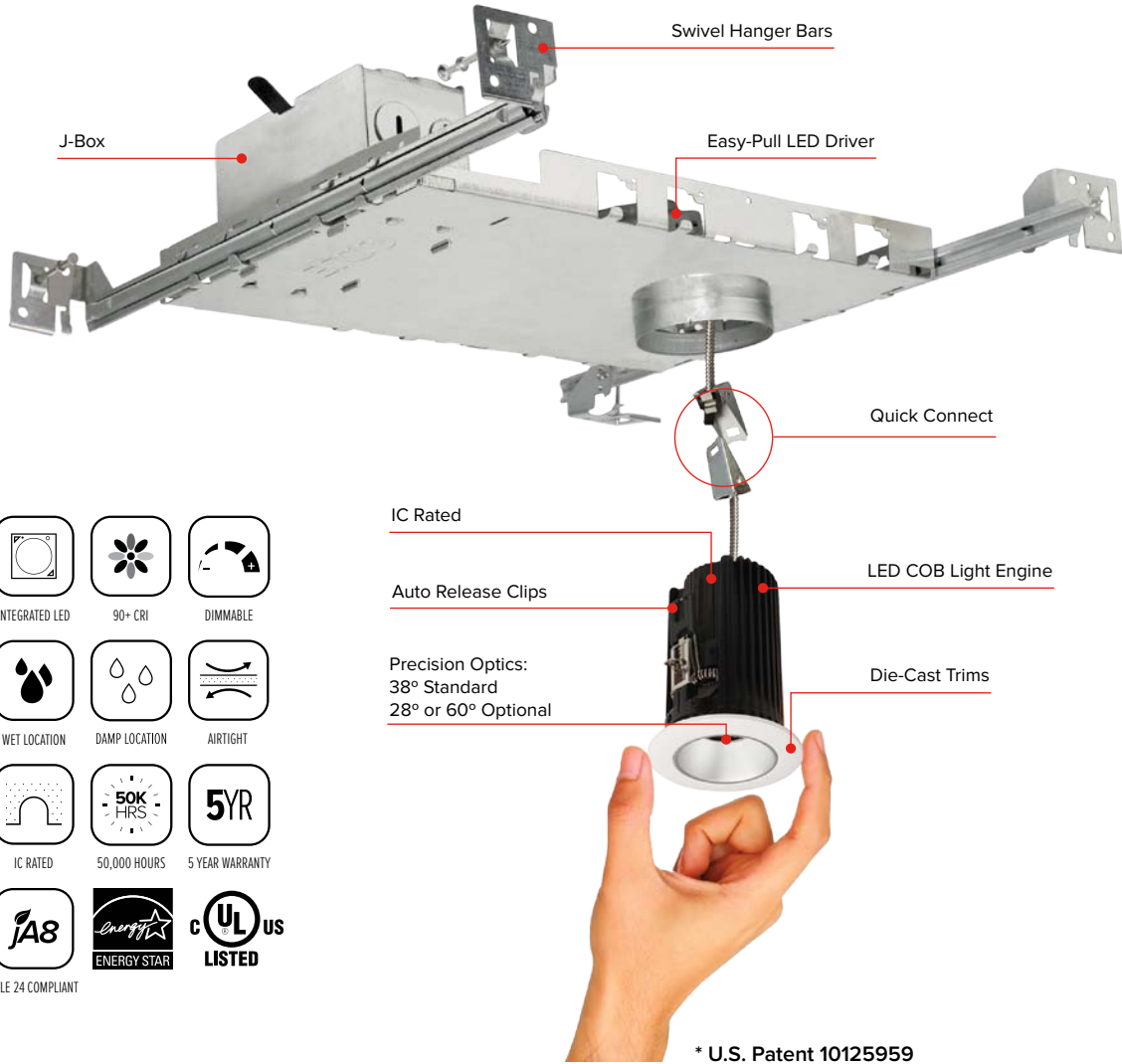





U.S. Patent 10125959







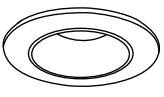
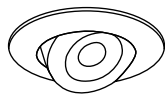

The **Teak™** System

2" LED Downlights & Adjustables

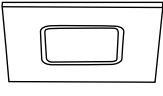

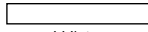
-  INTEGRATED LED
 -  90+ CRI
 -  DIMMABLE
 -  WET LOCATION
 -  DAMP LOCATION
 -  AIRTIGHT
 -  IC RATED
 -  50,000 HOURS
 -  5 YEAR WARRANTY
 -  IAS
 -  ENERGY STAR
 -  UL LISTED
- TITLE 24 COMPLIANT

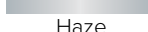
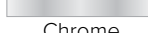
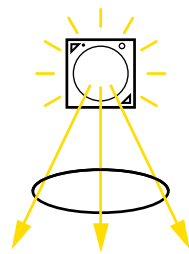
* U.S. Patent 10125959

STYLES	FINISHES	LUMENS	COLOR TEMPERATURE
 Round  Round Gimbal  Round Pull-Down  Square  Square Gimbal	 White  Black  Bronze  Haze  Chrome	 850 lm to 1100 lm	 2700K - 4000K

2" Teak™ IC Rated Frames

- Listed for direct contact with insulation
- Frame specified for 850 lumens (11.8W) and 1100 lumens (13.7W)
- Same LED module for both lumen outputs
- Driver specified for 120V (Triac/ELV dimming) or 120/277V (0-10V/Triac/ELV Dimming)
- Damp Location Listed, Wet Location with Wet Location Light Engines
- JA8-2016-E Listed, ENERGY Star Listed, UL Listed

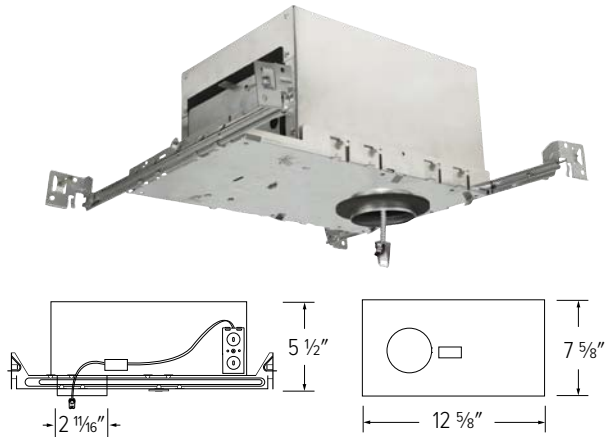

R60 ICA New Construction Housing

- For use with spray in R60 insulation
- Driver included on frame

Item	Lumens	Wattage	Voltage	Dimming
E2LAJ08ICA	850 lm	11.8W	120V	Triac/ELV
E2LAJ11ICA	1100 lm	13.7W	120V	Triac/ELV
E2LAJ08ICAD	850 lm	11.8W	120/277V	0-10V/Triac/ELV
E2LAJ11ICAD	1100 lm	13.7W	120/277V	0-10V/Triac/ELV

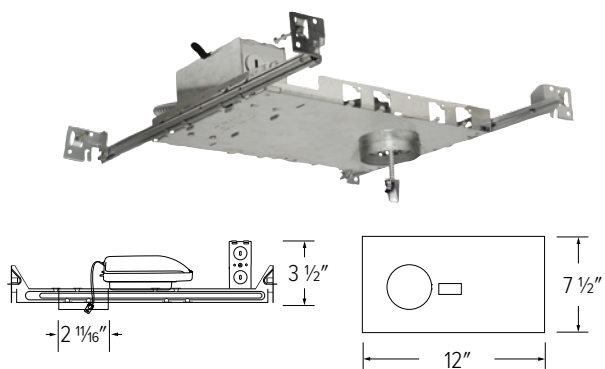

IC New Construction Frame

- Driver included on frame

Item	Lumens	Wattage	Voltage	Dimming
E2L08ICA	850 lm	11.8W	120V	Triac/ELV
E2L11ICA	1100 lm	13.7W	120V	Triac/ELV
E2L08ICAD	850 lm	11.8W	120/277V	0-10V/Triac/ELV
E2L11ICAD	1100 lm	13.7W	120/277V	0-10V/Triac/ELV

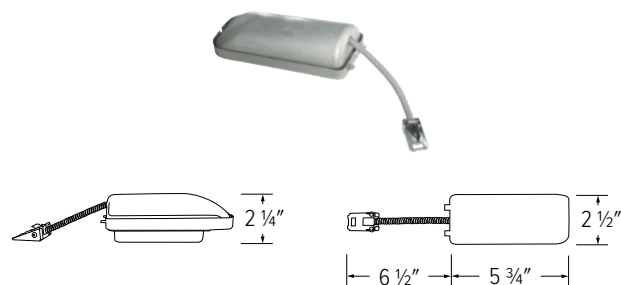

IC Remodel Power Pack

- Driver included

Item	Lumens	Wattage	Voltage	Dimming
E2L08RIC	850 lm	11.8W	120V	Triac/ELV
E2L11RIC	1100 lm	13.7W	120V	Triac/ELV
E2L08RICD	850 lm	11.8W	120/277V	0-10V/Triac/ELV
E2L11RICD	1100 lm	13.7W	120/277V	0-10V/Triac/ELV

Plaster Frames for Remodel Power Packs



Single Cutout
Plaster Frame
E2LF1



Multiple Cutout Plaster Frame
E2LF1-M2 (2 Set) E2LF1-M4 (4 Set)
E2LF1-M3 (3 Set) E2LF1-M5 (5 Set)
For row mounting fixtures.

2" Teak™ Round LED Light Engines

- Wet Location Rated for Indoor and Outdoor Use (Under covered ceilings)
- Same LED light engine for 850 and 1100 lumens (see housings)
- UL Listed for Direct Contact with insulation
- Standard with 38° beam. Field Changeable optics for 28° (EP716C) and 60° (EP718C)
- JA8-2016-E and Energy Star Listed
- Life Span 50,000 Hours L70

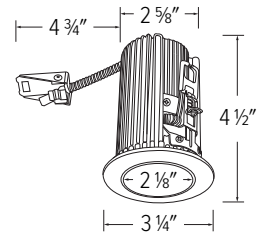

(W) All White



(BZ) All Bronze



(B) Black/White



(C) Chrome/White



(H) Haze/White



(BB) All Black

2" Round Reflector

Input Power	8.6W - 10.5W
Lumens	850 - 1100
Color Temperature	2700K - 4000K
CRI	93+
Wet Location	UL Listed
Dimmable	Yes

	2700K	3000K	3500K	4000K
	850/1100 lm	850/1100 lm	850/1100 lm	850/1100 lm
W	E2L10F27W	E2L10F30W	E2L10F35W	E2L10F40W
BZ	E2L10F27BZ	E2L10F30BZ	E2L10F35BZ	E2L10F40BZ
B	E2L10F27B	E2L10F30B	E2L10F35B	E2L10F40B
C	E2L10F27C	E2L10F30C	E2L10F35C	E2L10F40C
H	E2L10F27H	E2L10F30H	E2L10F35H	E2L10F40H
BB	E2L10F27BB	E2L10F30BB	E2L10F35BB	E2L10F40BB



(W) All White



(BZ) All Bronze



(B) Black/White



(BB) All Black

2" Round Baffle

Input Power	8.6W - 10.5W
Lumens	850 - 1100
Color Temperature	2700K - 4000K
CRI	93+
Wet Location	UL Listed
Dimmable	Yes

	2700K	3000K	3500K	4000K
	850/1100 lm	850/1100 lm	850/1100 lm	850/1100 lm
W	E2L14F27W	E2L14F30W	E2L14F35W	E2L14F40W
BZ	E2L14F27BZ	E2L14F30BZ	E2L14F35BZ	E2L14F40BZ
B	E2L14F27B	E2L14F30B	E2L14F35B	E2L14F40B
BB	E2L14F27BB	E2L14F30BB	E2L14F35BB	E2L14F40BB

Product Number Builder

2" Teak™ Light Engine	Style	Beam Angle	Color Temperature	Finish
E2L	10 Reflector 14 Baffle	F 38° (Standard) NF 28° WF 60°	27 2700K 30 3000K 35 3500K 40 4000K	W White BZ Bronze B Black/White C Chrome/White H Haze/White BB All Black

2" Teak™ Square LED Light Engines

- Wet Location Rated for Indoor and Outdoor Use (Under covered ceilings)
- Same module for 850 and 1100 lumens
- Listed for Direct Contact with insulation
- Standard with 38° beam. Field Changeable optics for 28° (EP716C) and 60° (EP718C)
- JA8-2016-E and Energy Star Listed
- Life Span 50,000 Hours L70

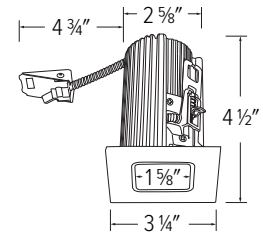

2" Square Reflector

Input Power	8.6W - 10.5W
Lumens	850 - 1100
Color Temperature	2700K - 4000K
CRI	93+
Wet Location	UL Listed
Dimmable	Yes

Finish	2700K 850/1100 lm	3000K 850/1100 lm	3500K 850/1100 lm	4000K 850/1100 lm
W	E2L13F27W	E2L13F30W	E2L13F35W	E2L13F40W
BZ	E2L13F27BZ	E2L13F30BZ	E2L13F35BZ	E2L13F40BZ
B	E2L13F27B	E2L13F30B	E2L13F35B	E2L13F40B
C	E2L13F27C	E2L13F30C	E2L13F35C	E2L13F40C
H	E2L13F27H	E2L13F30H	E2L13F35H	E2L13F40H
BB	E2L13F27BB	E2L13F30BB	E2L13F35BB	E2L13F40BB

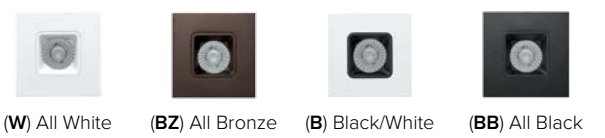

2" Square Baffle

Input Power	8.6W - 10.5W
Lumens	850 - 1100
Color Temperature	2700K - 4000K
CRI	93+
Wet Location	UL Listed
Dimmable	Yes

Finish	2700K 850/1100 lm	3000K 850/1100 lm	3500K 850/1100 lm	4000K 850/1100 lm
W	E2L15F27W	E2L15F30W	E2L15F35W	E2L15F40W
BZ	E2L15F27BZ	E2L15F30BZ	E2L15F35BZ	E2L15F40BZ
B	E2L15F27B	E2L15F30B	E2L15F35B	E2L15F40B
BB	E2L15F27BB	E2L15F30BB	E2L15F35BB	E2L15F40BB

**Product
Number
Builder**

2" Teak™ Light Engine	Style	Beam Angle	Color Temperature	Finish
E2L	13 Reflector 15 Baffle	F 38° (Standard) NF 28° WF 60°	27 2700K 30 3000K 35 3500K 40 4000K	W White BZ Bronze B Black/White C Chrome/White H Haze/White BB All Black

2" Teak™ Adjustable LED Light Engines

- 35° Adjustability
- Damp Location Rated
- Same module for 850 and 1100 lumens
- Listed for Direct Contact with insulation
- Standard with 38° beam. Field Changeable optics for 28° (EP716C) and 60° (EP718C)
- JA8-2016-E and Energy Star Listed
- Life Span 50,000 Hours L70

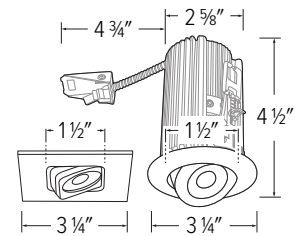

2" Round Adjustable

Input Power 8.6W - 10.5W
Lumens 850 - 1100
Color Temperature 2700K - 4000K
CRI 93+
Damp Location UL Listed
Dimmable Yes

Finish	2700K 850/1100 lm	3000K 850/1100 lm	3500K 850/1100 lm	4000K 850/1100 lm
W	E2L18F27W	E2L18F30W	E2L18F35W	E2L18F40W
BZ	E2L18F27BZ	E2L18F30BZ	E2L18F35BZ	E2L18F40BZ
B	E2L18F27B	E2L18F30B	E2L18F35B	E2L18F40B



2" Square Adjustable

Input Power 8.6W - 10.5W
Lumens 850 - 1100
Color Temperature 2700K - 4000K
CRI 93+
Damp Location UL Listed
Dimmable Yes

Finish	2700K 850/1100 lm	3000K 850/1100 lm	3500K 850/1100 lm	4000K 850/1100 lm
W	E2L19F27W	E2L19F30W	E2L19F35W	E2L19F40W
BZ	E2L19F27BZ	E2L19F30BZ	E2L19F35BZ	E2L19F40BZ
B	E2L19F27B	E2L19F30B	E2L19F35B	E2L19F40B

**Product
Number
Builder**

2" Teak™ Light Engine	Style	Beam Angle	Color Temperature	Finish
E2L	18 Round 19 Square	F 38° (Standard) NF 28° WF 60°	27 2700K 30 3000K 35 3500K 40 4000K	W White BZ Bronze B All Black

Dimmer Compatibility Chart

Manufacturer	Product	Part Number	Dimmed Light Output Range
Triac/ELV Type Dimmers			
Eaton	AL Series, Decorator Single-Pole/3-Way Preset Dimmer	DAL06P	10% - 100%
	DEVINE Decorator, Single Pole/3-Way Dimmer	DLC03P	10% - 100%
	SKYE Slide, Single-Pole/3-Way Preset Dimmer	SLC03P	10% - 100%
Leviton	Decora 4-Level Step Electro-Mechanical Incandescent Dimmer	6161-W	10% - 100%
	Decora Incandescent Dimmer, Single Pole Slide-to-Off with Optional Locator Light	6631-L	10% - 100%
	Decora Incandescent Dimmer, Single Pole/3-Way with Preset ON/OFF Switch	6633-PL	10% - 100%
	Trimatron Deluxe 3-Way Electro-Mechanical Incandescent Rotary Dimmer with Push ON/OFF	6683-IW	10% - 100%
	Decora Incandescent Dimmer with LED Locator	IPI06-1L	10% - 100%
	Decora Single-Pole/3-Way, IllumaTech Preset Electro-Mechanical Electronic Low-Voltage Slide Dimmer	IPE04-1L	10% - 100%
	Vizia+ Electronic Low Voltage Dimmer with LED Locator and Brightness Display: Neutral Required	VPE06-1L	10% - 100%
Lightolier	Sunrise Quiet Electronic Low Voltage Dimmer	ZP260QE	10% - 100%
Lutron	Skylark Contour® Single Pole/3-Way Incandescent/Halogen or Magnetic Low Voltage, Preset Dimmer	CT-103P	10% - 100%
	Diva® Series Single Pole Dimmer	DV-600P	10% - 100%
	Diva® Series 150W Single Pole/3-Way Dimmer	DVCL-153P	5% - 86%
	Diva® (gloss) 3-Way, Electronic Low Voltage Dimmer	DVELV-303P	10% - 100%
	Faedra® Single Pole, Electronic Low Voltage Dimmer	FAELV-500	10% - 100%
	Lumea® Gloss Single Pole, Incandescent/Halogen, Preset Dimmer	LG-600PH	10% - 100%
	Maestro® (Gloss) Single Pole/Multi-Location, Electronic Low Voltage Dimmer	MAELV-600	10% - 100%
	Skylark® Series 600W Single Pole	S-600P	10% - 100%
	Skylark® Single Pole/3-Way, Incandescent/Halogen, Preset, "Eco-Dim" Dimmer	S-603PG	5% - 85%
	Skylark® 300W, Single Pole, Electronic Low Voltage, Preset Dimmer	SELV-300P	10% - 100%
	Ariadni®/Toggler® Single Pole, Incandescent/Halogen Dimmer	TG-600P	10% - 100%
Ariadni®/Toggler® Series 150W Single Pole/3-Way Dimmer	TGCL-153P	5% - 86%	
0–10V Type Dimmers			
Lutron	Diva® (Gloss) Single Pole. Must be used with power pack model PP-DV (120-277V) or PP-347H (347V)	DVTV	10% - 100%
	Nova® Single Pole. Must be used with power pack model PP-DV (120-277V), or PP-347H (347V)	NFTV	10% - 100%

For Reference Only: Testing conducted by ELCO Lighting is not a substitute for and does not imply certification by an independent laboratory or any other standards certification. Refer to manufacturer specifications for more detailed information on product certifications and standards. Consult the dimmer manufacturer prior to installation to ensure compatibility.

*NOTE: Refer to dimmer manufacturer's documentation for installation instructions and circuit details

ELCAT1059



EL ELCO Lighting

Corporate Headquarters **Customer Service**

2042 E. Vernon Ave.
Vernon, CA 90058
Tel: 323.231.2600
Fax: 323.231.3200
elcolighting.com

Tel: 800.522.2626
Fax: 800.644.2626
orderdesk@elcolighting.com
customerservice@elcolighting.com
sales@elcolighting.com

Printed in the U.S.A. 02.19
\$10.00

© ELCO Lighting. The marks appearing in this catalog are registered trademarks of ELCO Lighting. Other marks used herein are recognized trademarks of their respective companies. Products shown in this brochure may be covered by U.S. and international patents. Specifications subject to change without notice.