

6" IC Airtight New Construction Dedicated Housing

6" new construction dedicated LED housing. Compatible with 6" LED inserts. Can include step-down transformer.

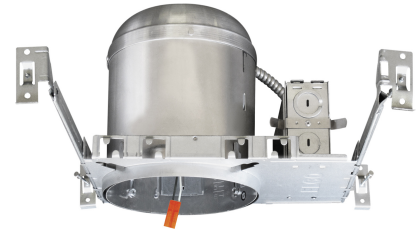

Features

- Single Wall IC Airtight Construction, for use in insulated ceilings.
- Transformer (EL770ICA-7 only): 277V to 120V step-down transformer.
- Meets Title 24 requirements. ENERGY STAR® Certified.
- Trims and inserts sold separately.

Specifications

Wattage	8W - 24W
Voltage	120/277V or 277V
Damp Location Listed	

Dimensions

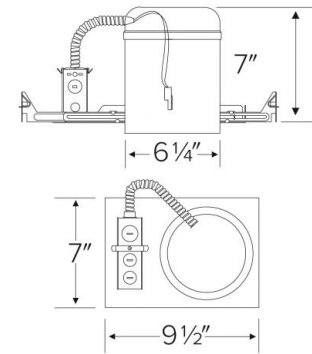

Technical Details

Construction:

- Single wall IC rated for direct contact with insulation, for use in IC or non-IC conditions.
- Housing adjusts in frame to accommodate up to 1 1/4" ceiling thickness.
- Airtight housing with gasket to restrict airflow in accordance with ASTM E-283 air-tight requirements.
- Steel housing for greater heat dissipation. Stamped galvanized steel frame.

Installation: Designed for ceiling plenums where 2x8 joists or taller joists are used. High strength hanger bars can easily be nailed to joists. Maximum hole cutout is 6 1/4". Suitable for T-grid and drop ceiling applications. See installation sheet for detailed information.

Junction Box: Positioned to accommodate straight conduit runs. Seven 1/2" trade size conduit knockouts, four 3/4" knockouts. Pry-out knockout slots. 4 Romex pryouts with strain relief.

Hanger Bars: Pre-installed hanger bars with TrueNail facilitate easy installation in regular lumber, engineered lumber, and laminated beams. Integral T-bar slots for easy installation in T-bars. Spans up to 24" and can be repositioned 90°. Score lines allow for tool-free hanger bar size reduction. Integral leveling flange allows for single-person installation while aligning the housings with the joists.

Electrical:

- Input Voltage: 120V AC.
- Inherently protected.

Trims: Compatible with ELCO 6" LED Inserts.

Dimmability:

- Dimmability based on lamp.

Lamp: Designed for use with ELCO 6" LED inserts, LED modules, or PSA37 with 6" MR16 trims.

Listings:

- UL Listed for Damp Location.
- UL Listed for Wet Location with select trims.
- UL Listed for Feed Through.
- UL Listed for Direct Contact with Insulation and Combustible Material.
- Airtight per ASTM E-283.
- Install a JA8-2016-E lamp for Title 24 Compliance.

Warranty: ELCO Lighting warrants products will be free from defects in materials and workmanship for a period of 5 years.

Product Numbers

Item	Description	Watts	Voltage
EL770ICA		24W	120V
EL770ICA-7	with Step-down Transformer 277V to 120V	24W	277V
EL770ICA-EM5	Emergency Battery Backup	8W	120/277V

For use with Dedicated 6" IC LED Housings

6" Downlight Round LED Light Engines

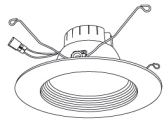

EL610
Round Baffle

Finish:
(W)

EL61027W	2700K / 725 lm
EL61030W	3000K / 750 lm
EL61040W	4000K / 800 lm

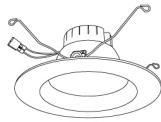

EL615
Round Reflector

Finish:
(W, BZ)

EL61527(W/BZ)	2700K / 800lm
EL61530(W/BZ)	3000K / 850 lm
EL61535(W/BZ)	3500K / 900 lm
EL61540W	4000K / 800 lm
EL61550W	5000K / 950 lm

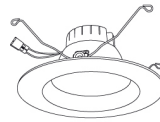

EL655
Builder Round Reflector

Finish:
(W)

EL65527W	2700K / 850lm
EL65530W	3000K / 850 lm

6" Downlight High-Lumen LED Light Engines

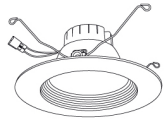

EL611, EL612
Round Baffle

Finish:
(W)

EL61130W	3000K / 1000 lm
EL61140W	4000K / 1100 lm
EL61230W	3000K / 1400 lm

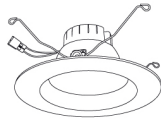

EL617, EL627
Round Reflector

Finish:
(W)

EL61727W	2700K / 1000lm
EL61730W	3000K / 1000 lm
EL61735W	3500K / 1000 lm
EL61740W	4000K / 1000 lm
EL62727W	2700K / 1400 lm
EL62730W	3000K / 1400 lm
EL62735W	3500K / 1400 lm
EL62740W	4000K / 1400 lm

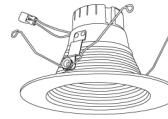

EL621
Round Deep Baffle

Finish:
(W)

EL62127W	2700K / 1000lm
EL62130W	3000K / 1000 lm

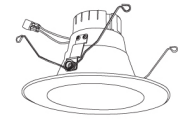

EL625
Round Deep Reflector

Finish:
(W, C, H)

EL62527(W/C/H)	2700K / 1000lm
EL62530(W/C/H)	3000K / 1000 lm
EL62535(W/C/H)	3500K / 1000 lm
EL62540(W/C/H)	4000K / 1000 lm

6" Downlight Square LED Light Engines



EL661
Square Baffle

Finish:
(W)

EL66130W	3000K / 1200 lm
-----------------	-----------------



EL662
Square Reflector

Finish:
(W)

EL66230W	3000K / 1200 lm
-----------------	-----------------

For use with Dedicated 6" IC LED Housings

6" Downlight Adjustable LED Light Engines



EL613
Adjustable Gimbal

Finish:
(W, B)



EL616
Adjustable

Finish:
(W)

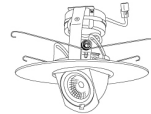

EL697
Adjustable Pull Down

Finish:
(W, B, BZ, N)

EL61327W/B 2700K / 1100 lm

EL61330W/B 3000K / 1150 lm

EL61627W 2700K / 930 lm

EL61627W 3000K / 950 lm

EL69727W/B/BZ/N 2700K / 800lm

EL69730W/B/BZ/N 3000K / 840 lm

6" Downlight Sunset Dimming LED Light Engines

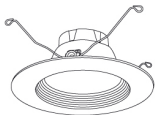

EL610SD
Round Baffle

Finish:
(W, BZ)

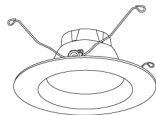

EL615SD
Round Reflector

Finish:
(W, BZ)

EL610SDW/BZ Sunset / 750 lm

EL615SDW/BZ Sunset / 750 lm

6" Downlight with PAR30 Gimbal LED Light Engines

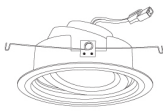

EL376
Adjustable Baffle

Finish:
(W, B, BZ, N)



EL377
Adjustable Reflector

Finish:
(W, B, C)

EL37627W/B/BZ/N 2700K / 1050lm

EL37630W/B/BZ/N 3000K / 1050 lm

EL37727W/B/C 2700K / 1050lm

EL37730W/B/C 3000K / 1050 lm

6" Downlight with PAR38 Gimbal LED Light Engines



EL476
Adjustable Baffle

Finish:
(W, B, BZ, N)



EL477
Adjustable Reflector

Finish:
(W, B, C)

EL47627W/B/BZ/N 2700K / 1200lm

EL47630W/B/BZ/N 3000K / 1200 lm

EL47727W/B/C 2700K / 1200lm

EL47730W/B/C 3000K / 1200 lm