



**6GB-ILP**  
**6GB-ING**

# **6GB BUILDER SERIES**

# **INDOOR MANUAL**

WHOLE-HOME TANKLESS WATER HEATERS  
INSTALLATION, USE AND CARE INSTRUCTIONS

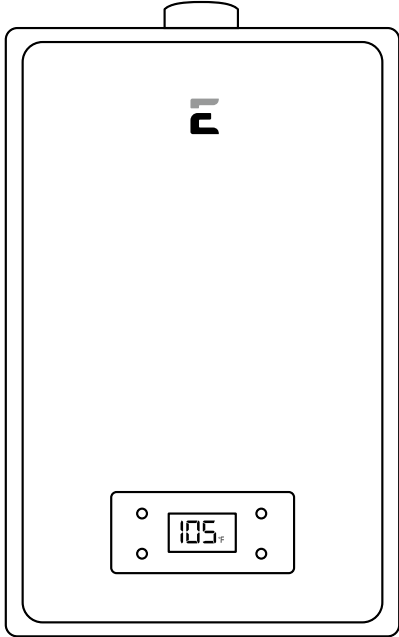

WHOLE HOME



MID SIZE HOME



TOWN HOME



APARTMENT / CONDOS



SHOWER



TINY HOUSE



CABINS

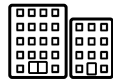







OFFICE

**WARNING! If the information in these instructions is not followed exactly, a fire or explosion may result causing property damage, personal injury or death.**





- **Do not store or use gasoline or other flammable vapors and liquids in the vicinity of this or any other appliances.**
- **WHAT TO DO IF YOU SMELL GAS**
  - **Do not try to light any appliances.**
  - **Do not touch any electrical switch; do not use any phone in your building.**
  - **Immediately call your gas supplier from a neighbor's phone. Follow the gas supplier's instructions.**
  - **If you cannot reach your gas supplier, call the fire department.**
- **Installation and service must be performed by a qualified installer, service agency or the gas supplier.**



 EcoTemp Systems, LLC 315-A Industrial Road Summerville, SC 29483 866-356-1992		  	
<b>AUTOMATIC INSTANTANEOUS WATER HEATER</b>			
MODEL #:	<b>6GB-ILP</b>	Maximum Input Rating (Btu per hour):	145,000
SERIAL #		Minimum Input Rating (Btu per hour):	18,000
GAS TYPE:	<b>LIQUID PROPANE ONLY</b>	Minimum Inlet Gas Pressure:	8.0" W.C. (1.99 kPa)
Voltage:	120 Volts	Maximum Inlet Gas Pressure:	13" W.C. (3.23 kPa)
Frequency:	60 Hz	Manifold Pressure:	5.1" w.c. (1.27 kPa)
Amps:	Less than 10 Amperes	Maximum Working Pressure:	150 PSI
Recovery Rating:	As used in this standard, the quantity of water obtained by multiplying the manufacturer's input rating in Btu per hour by the thermal efficiency and dividing the product by 8.25 Btu per gallon. This is based on a 100°F (37.8°C) temperature rise, and a nominal specific heat for water of 8.25 Btu per gallon per degree F.		
Not recommended in excess of 2,000 ft. above sea level.		Category III Type B Water Heater	
<b>CANADIAN HIGH ALTITUDE RATING</b>			
Altitude	0-2000 feet		
Input (btu/hr)	180,000		
Manifold pressure (in. w.c.)	5.1		
CSA/ANSI Z21.10.3 - CSA 4.3-2021		SUITABLE FOR WATER (PORTABLE) HEATING ONLY	
<b>FOR YOUR SAFETY</b> Do not store or use gasoline or other flammable vapors and liquids in the vicinity of this or any other appliance.		This appliance must be installed in accordance with local codes or, in the absence of local codes, the National Fuel Gas Code, ANSI Z223.1/NFPA 54 or the CSA B149.1, Natural Gas and Propane Installation Code.	
The unit must be installed on a fire retardant area, and must be away from all combustible materials. Clearance should be 1.75 ft to the left and right side of combustible materials, and 6.75 ft to the front.			
<b>OPEN ON THREE SIDES AND AN OVERHEAD CLEARANCE OF 36"</b>			
The temperature and pressure relief valve provided by the manufacturer shall be installed at the time of installation of the heater in the location specified by the manufacturer. Local codes shall govern installation of relief devices. For safe operation of the water heater, the relief valve must not be removed or plugged.			
<b>INDOOR USE ONLY</b>			

 EcoTemp Systems, LLC 315-A Industrial Road Summerville, SC 29483 866-356-1992		  	
<b>CHAUFFE-EAU INSTANTANÉ AUTOMATIQUE</b>			
MODÈLE #:	<b>6GB-ILP</b>	Puissance d'entrée Maximale (Btu par heure):	145,000
EN SÉRIE #:		Puissance d'entrée Minimale (Btu par heure):	18,000
TYPE DE GAZ:	<b>PROPANE LIQUIDE</b> SEULEMENT	Pression Minimale du Gaz d'entrée:	8.0" W.C. (1.99 kPa)
Tension:	120 Volts	Pression Maximale du Gaz d'entrée :	13" W.C. (3.23 kPa)
Fréquence:	60 Hz	Pression du Collecteur:	5.1" w.c. (1.27 kPa)
Ampli:	Moins de 10 ampères	Pression de Service Maximale:	150 PSI
Recupération Notation:	Telle qu'utilisée dans cette norme, la quantité d'eau obtenue en multipliant la valeur nominale d'entrée du fabricant en Btu par heure par l'efficacité thermique et en divisant le produit par 8.25 Btu par gallon. Ceci est basé sur une augmentation de température de 100 °F (37.8 °C) et une chaleur spécifique nominale pour l'eau de 8.25 Btu par gallon par degré F.		
Non recommandé à plus de 2 000 pieds au-dessus du niveau de la mer.		Chauffe-eau de catégorie III de type B	
<b>COTE CANADIENNE DE HAUTE ALTITUDE</b>			
Altitude	0-2000 pieds		
Entrée (btu/hr)	180 000		
Pression du Collecteur (po CE)	5.1		
CSA/ANSI Z21.10.3 - CSA 4.3-2021		ADAPTÉ AU CHAUFFAGE DE L'EAU (PORTABLE) UNIQUEMENT	
<b>POUR VOTRE SÉCURITÉ</b> Ne stockez pas et n'utilisez pas de essence ou d'autres vapeurs et liquides inflammables à proximité de cet appareil ou de tout autre appareil.		Cet appareil doit être installé conformément aux codes locaux ou, en l'absence de codes locaux, au National Fuel Gas Code, ANSI Z223.1/NFPA 54 ou au CSA B149.1, Code d'installation du gaz naturel et du propane.	
L'unité doit être installée sur une zone ignifuge et doit être éloignée de tout matériau combustible. Le dégagement doit être de 1.75 pi à gauche et à droite des matériaux combustibles et de 6.75 pi à l'avant.			
<b>OUVERT SUR TROIS CÔTÉS ET UN DÉGAGEMENT AÉRIEN DE 36"</b>			
Le souape de surpression de température et de pression fournie par le fabricant doit être installée au moment de l'installation du réchauffeur à l'emplacement spécifié par le fabricant. Les codes locaux exigent l'installation des dispositifs de secours. Pour un fonctionnement sécuritaire du chauffe-eau, le souape de décharge ne doit pas être retiré ou bouché.			
<b>UTILISATION EN INTÉRIEUR UNIQUEMENT</b>			

 EcoTemp Systems, LLC 315-A Industrial Road Summerville, SC 29483 866-356-1992		  	
<b>AUTOMATIC INSTANTANEOUS WATER HEATER</b>			
MODEL #:	<b>6GB-ING</b>	Maximum Input Rating (Btu per hour):	145,000
SERIAL #		Minimum Input Rating (Btu per hour):	18,000
GAS TYPE:	<b>NATURAL GAS ONLY</b>	Minimum Inlet Gas Pressure:	8.0" W.C. (1.99 kPa)
Voltage:	120 Volts	Maximum Inlet Gas Pressure:	13" W.C. (3.23 kPa)
Frequency:	60 Hz	Manifold Pressure:	5.1" w.c. (1.27 kPa)
Amps:	Less than 10 Amperes	Maximum Working Pressure:	150 PSI
Recovery Rating:	As used in this standard, the quantity of water obtained by multiplying the manufacturer's input rating in Btu per hour by the thermal efficiency and dividing the product by 8.25 Btu per gallon. This is based on a 100°F (37.8°C) temperature rise, and a nominal specific heat for water of 8.25 Btu per gallon per degree F.		
Not recommended in excess of 2,000 ft. above sea level.		Category III Type B Water Heater	
<b>CANADIAN HIGH ALTITUDE RATING</b>			
Altitude	0-2000 feet		
Input (btu/hr)	180,000		
Manifold pressure (in. w.c.)	5.1		
CSA/ANSI Z21.10.3 - CSA 4.3-2021		SUITABLE FOR WATER (PORTABLE) HEATING ONLY	
<b>FOR YOUR SAFETY</b> Do not store or use gasoline or other flammable vapors and liquids in the vicinity of this or any other appliance.		This appliance must be installed in accordance with local codes or, in the absence of local codes, the National Fuel Gas Code, ANSI Z223.1/NFPA 54 or the CSA B149.1, Natural Gas and Propane Installation Code.	
The unit must be installed on a fire retardant area, and must be away from all combustible materials. Clearance should be 1.75 ft to the left and right side of combustible materials, and 6.75 ft to the front.			
<b>OPEN ON THREE SIDES AND AN OVERHEAD CLEARANCE OF 36"</b>			
The temperature and pressure relief valve provided by the manufacturer shall be installed at the time of installation of the heater in the location specified by the manufacturer. Local codes shall govern installation of relief devices. For safe operation of the water heater, the relief valve must not be removed or plugged.			
<b>INDOOR USE ONLY</b>			

 EcoTemp Systems, LLC 315-A Industrial Road Summerville, SC 29483 866-356-1992		  	
<b>CHAUFFE-EAU INSTANTANÉ AUTOMATIQUE</b>			
MODÈLE #:	<b>6GB-ING</b>	Puissance d'entrée Maximale (Btu par heure):	145,000
EN SÉRIE #:		Puissance d'entrée Minimale (Btu par heure):	18,000
TYPE DE GAZ:	<b>GAZ NATUREL</b> SEULEMENT	Pression Minimale du Gaz d'entrée:	8.0" W.C. (1.99 kPa)
Tension:	120 Volts	Pression Maximale du Gaz d'entrée :	13" W.C. (3.23 kPa)
Fréquence:	60 Hz	Pression du Collecteur:	5.1" w.c. (1.27 kPa)
Ampli:	Moins de 10 ampères	Pression de Service Maximale:	150 PSI
Recupération Notation:	Telle qu'utilisée dans cette norme, la quantité d'eau obtenue en multipliant la valeur nominale d'entrée du fabricant en Btu par heure par l'efficacité thermique et en divisant le produit par 8.25 Btu par gallon. Ceci est basé sur une augmentation de température de 100 °F (37.8 °C) et une chaleur spécifique nominale pour l'eau de 8.25 Btu par gallon par degré F.		
Non recommandé à plus de 2 000 pieds au-dessus du niveau de la mer.		Chauffe-eau de catégorie III de type B	
<b>COTE CANADIENNE DE HAUTE ALTITUDE</b>			
Altitude	0-2000 pieds		
Entrée (btu/hr)	180 000		
Pression du Collecteur (po CE)	5.1		
CSA/ANSI Z21.10.3 - CSA 4.3-2021		ADAPTÉ AU CHAUFFAGE DE L'EAU (PORTABLE) UNIQUEMENT	
<b>POUR VOTRE SÉCURITÉ</b> Ne stockez pas et n'utilisez pas de essence ou d'autres vapeurs et liquides inflammables à proximité de cet appareil ou de tout autre appareil.		Cet appareil doit être installé conformément aux codes locaux ou, en l'absence de codes locaux, au National Fuel Gas Code, ANSI Z223.1/NFPA 54 ou au CSA B149.1, Code d'installation du gaz naturel et du propane.	
L'unité doit être installée sur une zone ignifuge et doit être éloignée de tout matériau combustible. Le dégagement doit être de 1.75 pi à gauche et à droite des matériaux combustibles et de 6.75 pi à l'avant.			
<b>OUVERT SUR TROIS CÔTÉS ET UN DÉGAGEMENT AÉRIEN DE 36"</b>			
Le souape de surpression de température et de pression fournie par le fabricant doit être installée au moment de l'installation du réchauffeur à l'emplacement spécifié par le fabricant. Les codes locaux exigent l'installation des dispositifs de secours. Pour un fonctionnement sécuritaire du chauffe-eau, le souape de décharge ne doit pas être retiré ou bouché.			
<b>UTILISATION EN INTÉRIEUR UNIQUEMENT</b>			

PLEASE NOTE: 6GB IS FOR INDOOR PERMANENT INSTALLATIONS ONLY. THIS MANUAL AND ALL ECOTEMP CONTENT IS SUBJECT TO CHANGE WITHOUT NOTICE. PLEASE VISIT [WWW.ECOTEMP.COM/SUPPORT](http://WWW.ECOTEMP.COM/SUPPORT) FOR MORE INFORMATION.

# 6GB BUILDER SERIES INDOOR WHOLE-HOME TANKLESS WATER HEATERS

## USE & CARE MANUAL With Installation Instructions for the Installer

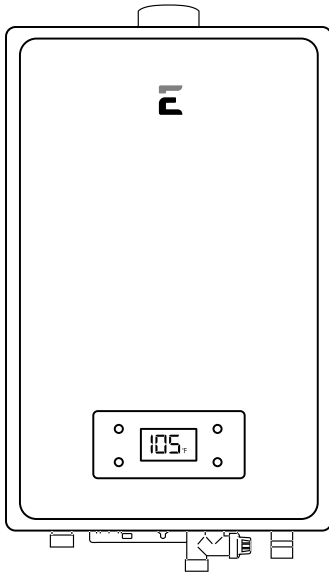

APPLICATION	INSTALLATION	TYPE	FLOW RATE
Whole Home	Indoor	LP and NG	6 GPM

## Tankless Water Heater

**⚠ WARNING!** This water heater may not be suitable for use in manufactured (mobile) homes! Please check local code restrictions pertaining to permanent/fixed installations in manufactured homes in your area.

The purpose of this manual is twofold: one, to provide the installer with the basic directions and requirements for the proper installation and adjustment of the water heater; and two, to the owner-operator, to explain the features, operation, safety precautions, maintenance and troubleshooting of the water heater. This manual also includes a part list.

It is imperative that all persons who are expected to install, operate, or adjust this water heater read the instructions carefully so they may understand how to perform these operations. If you don't understand these instructions or any term within it, seek professional advice. Any questions regarding the operation, maintenance, service or warranty of this water heater should be directed to the seller from whom it was purchased. If additional information is required, refer to the section on "If You Need Service".

**⚠ Recognize this symbol as an indication of Important Safety Information!**

**⚠ DO NOT destroy this manual. Please read carefully and keep in a safe place for future reference.**

**⚠ California Proposition 65 Warning: This product contains chemicals known to the State of California to cause cancer, birth defects or other reproductive harm.**

**⚠ WARNING! If the information in these instructions is not followed exactly, a fire or explosion may result causing property damage, personal injury, or death.**

### **⚠ FOR YOUR SAFETY!**

Improper installation, adjustment, alteration, service, or maintenance can cause property damage, personal injury, or death. Refer to this manual. Installation and service must be performed by an agency or the gas supplier.

**DO NOT** store or use gasoline or other flammable vapors or liquids or other combustible materials in the vicinity of this or any other appliance. To do so may result in an explosion or fire.

### **WHAT TO DO IF YOU SMELL GAS**

- DO NOT try to light any appliances.
- DO NOT touch any electrical switch; do not use any phone in your building.
- Immediately call your gas supplier from a neighbor's phone. Follow the gas supplier's instructions.
- If you cannot reach your gas supplier, call the fire department.
- DO NOT return to your home until authorized by the gas supplier or fire department.

# SAFETY INFORMATION

## Safety Information

Safety Precautions ..... 5-9

## 6GB Installation Instructions

Location ..... 11-12  
 Combustion & Ventilation Air ..... 13  
 Typical Installation ..... 14  
 Water Connections ..... 15  
 Gas Supply ..... 16  
 Relief Valve ..... 17  
 Leak Testing ..... 18  
 High Altitude ..... 18  
 Venting ..... 18-25  
 Electrical Connection ..... 26  
 Pipe Insulation ..... 27  
 Mounting ..... 28  
 Installation Checklist ..... 29

## Operation Instructions

Start Instructions ..... 30-31  
 Eco Mode ..... 31  
 Water Temperature ..... 32  
 Temperature Memory ..... 32

## Care and Cleaning

Maintenance ..... 33  
 Housekeeping ..... 34  
 Extended Shut-Down ..... 34  
 Anti-Freezing ..... 34  
 Draining ..... 35

## Troubleshooting

Before You Call For Service ..... 36  
 Error Code Guide ..... 37  
 Parts List ..... 38

## Warranty

Warranty ..... 39-40

## FOR YOUR RECORDS

Write your serial numbers here:

# \_\_\_\_\_

# \_\_\_\_\_

You can find them on a label on the appliance and/or packaging.

Staple sales slip or canceled check here.

Proof of the original purchase date is needed to obtain service under the warranty.

## READ THIS MANUAL

Inside you will find many useful tips on how to use and maintain your water heater correctly. A little preventative care on your part can save you time and money over the life of your water heater. You'll find many answers to common problems in the Troubleshooting Guide. If you check the Troubleshooting Tips table first, you may not need to call for service.

## READ THE SAFETY INFORMATION

Your safety and the safety of others are very important. There are many important safety messages in this manual and on your water heater. Always read and obey all safety messages.

 This is the safety alert symbol. Recognize this symbol as an indication of Important Safety Information! This symbol alerts you to potential hazards that can kill or hurt you and others.

All safety messages will follow the safety alert symbol and the words: "DANGER", "WARNING", "CAUTION" or "NOTICE".

These words mean:

 **DANGER!** An imminently hazardous situation that will result in death or serious injury.

 **WARNING!** A potentially hazardous situation that could result in death or serious injury and/or damage to property.

 **CAUTION!** A potentially hazardous situation that may result in minor or moderate injury.

 **NOTICE!** Attention is called to observe a specified procedure or maintain a specific condition.

# IMPORTANT SAFETY INFORMATION: READ ALL INSTRUCTIONS BEFORE USE

Be sure to read and understand the entire Use and Care Manual before attempting to install or operate this water heater. It can save you time and money. Pay particular attention to the Safety Instructions. Failure to follow these warnings could result in serious bodily injury or death. Should you have problems understanding the instructions in this manual, or have any questions, **STOP** and get help from a qualified service technician, or the local gas utility.

## **! DANGER!**

### PROPERLY INSTALL WATER HEATER

Failure to properly install the water heater as outlined in the Installation Instructions in this manual can result in unsafe operation of the water heater. To avoid the risk of fire, explosion, or asphyxiation from carbon monoxide, never operate this water heater unless it is installed properly and has adequate air supply for proper operation. Be sure to inspect the flue terminal for proper installation at initial start-up; and at least annually thereafter. Refer to the Care and Cleaning section of this manual for more information regarding flue terminal inspection.

## **! WARNING!**

### FLAMMABLE OR COMBUSTIBLE MATERIALS

Gasoline, as well as other flammable materials and liquids (adhesives, solvents, paint thinners etc.), and the vapors they produce are extremely dangerous. **DO NOT** handle, use or store gasoline or other flammable or combustible materials anywhere near or in the vicinity of a water heater or any other appliance. Be sure to read and follow the labels on the water heater, as well as the warnings printed in this manual. Failure to do so can result in property damage, bodily injury or death.

DANGER



Flammable Vapor

**! Vapors from flammable liquids will explode and catch fire causing death or severe burns.**

**DO NOT** use or store flammable products such as gasoline, solvents or adhesive in the same room or area near the water heater.

Keep flammable products:

1. Far away from heater
2. In approved cont
3. Tightly closed
4. Out of children's reach

**Water heater has a main burner flame.**

The main burner flame:

1. Can come on at any time and
2. will ignite flammable vapors.

Vapors:

1. Cannot be seen
2. Are heavier than air
3. Go a long way on the floor
4. Can be carried from other rooms to the main burner flame by air currents.

**Installation:**

Do not install water heater where flammable products will be stored or used unless the main burner flame is at least 18" above the floor. This will reduce, but not eliminate, the risk of vapors being ignited by the main burner flame.

Read and follow water heater warnings and instructions. If owners manual is missing, contact the retailer or manufacturer.

PLEASE NOTE: 6GB IS FOR INDOOR PERMANENT INSTALLATIONS ONLY. THIS MANUAL AND ALL ECCOTEMP CONTENT IS SUBJECT TO CHANGE WITHOUT NOTICE.  
PLEASE VISIT [WWW.ECCOTEMP.COM/SUPPORT](http://WWW.ECCOTEMP.COM/SUPPORT) FOR MORE INFORMATION.

# IMPORTANT SAFETY INFORMATION: READ ALL INSTRUCTIONS BEFORE USE

## **⚠ DANGER!**

### **WATER TEMPERATURE SETTING**

Safety and energy conservation are factors to be considered when selecting the water temperature setting. Water temperatures above 125°F can cause severe burns or death from scalding. The thermostat is adjusted to its lowest temperature position when shipped from the factory. Be sure to read and follow the warnings outlined on the label pictured below.

ATTENTION

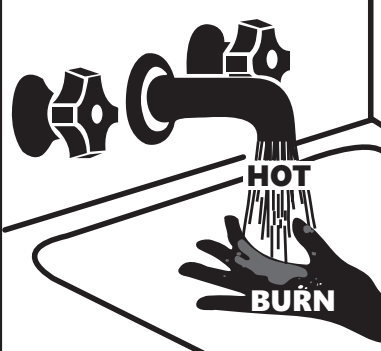

Water temperature over 125°F (51°C) can cause severe burns instantly or death scalds.

Children, disabled, and elderly are at highest risk of being scalded.

See instruction manual before setting temperature at water heater. Feel water before using. Temperature limiting valves are available.

Water Temperature	Time to Product a serious Burn
120	More than 5 minutes
125	1 1/2 to 2 minutes
130	About 30 seconds
135	About 10 seconds
140	Less than 5 seconds
145	Less than 3 seconds
150	About 1 1/2 seconds
155	About 1 second

Table courtesy of Shriners Burn Institute

The chart shown above may be used as a guide in determining the proper water temperature for your home.

**⚠ DANGER! Households with small children, disabled, or elderly persons may require a 120°F or lower temperature setting to prevent contact with "HOT" water.**

Maximum water temperature occurs while burner is on. To find water temperature being delivered, turn on a hot water faucet and place a thermometer in the water stream and read the thermometer.

The temperature of the water at the outlet of the water heater can be regulated by setting the temperature on the Remote Control. The remote control may have been set at 110°F before it was shipped from the factory.

**⚠ NOTICE! When this water heater is supplying general purpose hot water for use by individuals, a thermostatically controlled mixing valve for reducing point of use water temperature is recommended to reduce the risk of scald injury. Contact a licensed plumber or the local plumbing authority for further information.**

**⚠ NOTICE! The factory recommended operating temperatures are between 90°F and 140°F.**

# IMPORTANT SAFETY INFORMATION: READ ALL INSTRUCTIONS BEFORE USE

## DANGER!

### NATURAL GAS AND LIQUEFIED PETROLEUM MODELS

Both liquid propane gas (LPG) and natural gas (NG) have an odorant added to aid in detecting a gas leak. Some people may not physically be able to smell or recognize this odorant. If you are unsure or unfamiliar with the smell of LPG or NG, ask the gas supplier. Other conditions, such as "odorant fade", which causes the odorant to diminish in intensity, can also hide or camouflage a gas leak. Always check with commercial leak detector or soapy water.

- Gas detectors are recommended in LPG and NG applications and their installation should be in accordance with the detector manufacturer's recommendations and/or local laws, rules, regulations or customs.
- Water heaters utilizing LPG are different from NG models. A NG water heater will not function safely on LPG and vice versa.
- No attempt should ever be made to convert the water heater from NG to LPG. To avoid possible equipment damage, personal injury or fire, do not connect the water heater to a fuel type not in accordance with the water heater data plate; liquid propane gas for LPG water heaters and natural gas for NG water heaters. These water heaters are not certified for any other fuel type.
- LPG water heaters should not be installed below grade (for example, in a basement) if such installation is prohibited by federal, state, or local laws, rules, regulations, or codes.
- LPG must be used with great caution. It is heavier than air and will collect first in lower areas making it hard to detect at nose level.
- Before attempting to light the water heater, make sure to look and smell for gas leaks. Use a soapy solution to check all gas fittings and connections. Bubbling at a connection indicates a leak that must be corrected. When smelling to detect a gas leak, be sure to sniff near the floor also.
- It is recommended that more than one method, such as soapy solution, gas detectors, etc., be used to detect leaks in gas applications.

## NOTICE!

### IF A GAS LEAK IS PRESENT OR SUSPECTED:

- **DO NOT attempt to find the cause yourself.**
- **DO NOT try to light the water heater.**
- **DO NOT touch any electrical switch.**
- **DO NOT use any phone in your building.**
- **Leave the house immediately and make sure your family and pets leave also.**
- **Leave doors open for ventilation and contact the gas supplier, a qualified service agency or the fire department.**
- **Stay away from the house (or building) until the service call has been made, the leak is corrected, and a qualified agency has determined the area to be safe.**

PLEASE NOTE: 6GB IS FOR INDOOR PERMANENT INSTALLATIONS ONLY. THIS MANUAL AND ALL ECCOTEMP CONTENT IS SUBJECT TO CHANGE WITHOUT NOTICE.  
PLEASE VISIT [WWW.ECCOTEMP.COM/SUPPORT](http://WWW.ECCOTEMP.COM/SUPPORT) FOR MORE INFORMATION.



# IMPORTANT SAFETY INFORMATION: READ ALL INSTRUCTIONS BEFORE USE

## WARNING!

For your safety, the information in this manual must be followed to minimize the risk of fire explosion, electric shock, or to prevent property damage, personal injury, or loss of life.

## FOR INSTALLATIONS IN THE STATE OF CALIFORNIA

California Law requires that residential water heaters must be braced, anchored or strapped to resist falling or horizontal displacement due to earthquake motions. For residential water heaters up to 52 gallon capacity, a brochure with generic earthquake bracing instructions can be obtained from: Office of the State Architect, 400 P Street, Sacramento, CA 95814 or you may call 916-445-8100 or ask a water heater dealer.

However, applicable local codes shall govern installation. For residential water heaters of a capacity greater than 52 gallons or tankless style, consult the local building code for acceptable bracing procedures.

## SAFETY PRECAUTIONS

Have the installer show you the location of the gas shut-off valve and how to shut it off if necessary. Turn off the manual shut-off valve if the water heater has been subjected to overheating, fire, flood, physical damage or if the gas supply fails to shut-off.

- Read this manual entirely before installing or operating the water heater.
- Use this water heater only for its intended purpose as described in this Use and Care Manual.
- Be sure your water heater is properly installed in accordance with federal, state, and local codes and the provided installation instructions.
- All installations and servicing should be referred to a qualified technician.

## READ AND FOLLOW THIS SAFETY INFORMATION CAREFULLY SAVE THESE INSTRUCTIONS

This water heater must be installed in accordance with these local codes, utility company requirements, and/or in the absence of local codes, use the latest edition of the American National Standard/National Fuel Gas Code. A copy can be purchased from either the American Gas Association, 400 North Capitol Street NW, Washington, DC 20001 as ANSI standard Z223.1 or National Fire Protection Association, 1 Batterymarch Park, Quincy, MA 02269 as NFPA 54. In Canada, the latest edition of the CSA B149.1 Natural Gas and Propane Installation, and the Canadian Electrical Code, CSA C22.1 Part 1, in the absence of local codes.

# INSTALLING THE 6GB WATER HEATER

ENGLISH

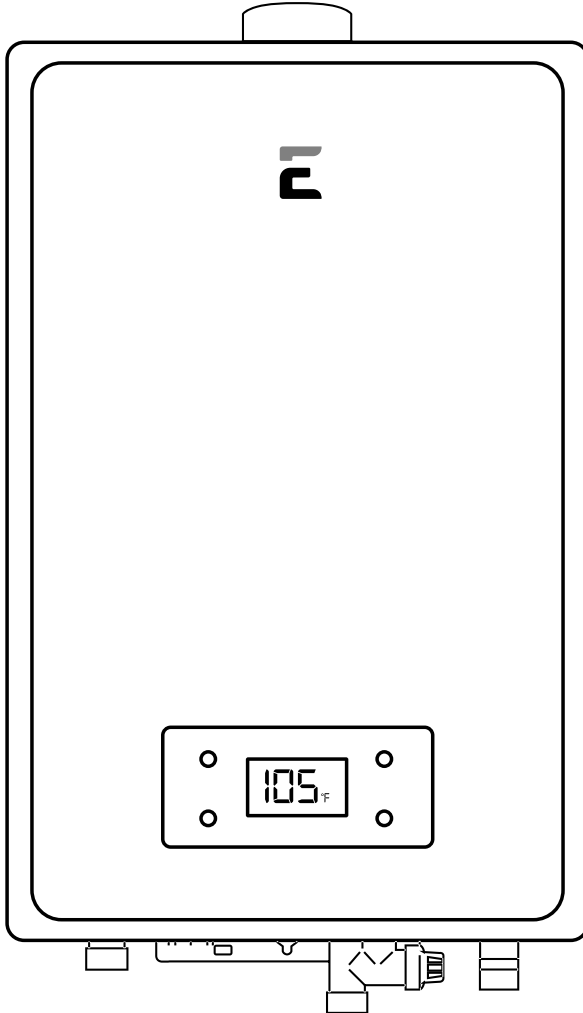

PLEASE NOTE: 6GB IS FOR INDOOR PERMANENT INSTALLATIONS ONLY. THIS MANUAL AND ALL ECCOTEMP CONTENT IS SUBJECT TO CHANGE WITHOUT NOTICE.  
PLEASE VISIT [WWW.ECCOTEMP.COM/SUPPORT](http://WWW.ECCOTEMP.COM/SUPPORT) FOR MORE INFORMATION.

# INSTALLING THE 6GB WATER HEATER

## LOCATION

- **INSTALL INDOORS**
- Installation distances may vary by local code. It is the installer's responsibility to verify installation requirements.
- Make sure before installation that the gas type you will use is the same type on the data plate.
- Failure to properly install the water heater as outlined in this manual can result in unsafe operation and possibly voiding the manufacturer's warranty.
- Water heater cannot be installed in an UN-VENTED bathroom, basement, living room, closet, indoor, stairway or an exit area. If installed in an exit area, it must be at least 16.5 ft. or more away from the exit.
- Vent pipe should extend from the wall at least 2". The terminal must be at least 1.64 ft. away from obstruction and must be well vented.
- Ensure a backflow preventer has been installed to the vent piping.
- Install a condensation trap and drain (as required).
- Vent pipe should slope 3° downward, to avoid condensing water and protect from rain entering.
- Vent pipe should avoid direct, strong wind because the downdraft will cause malfunction.
- The water heater should be installed far from any blockage, and with plenty of space for installation and maintenance. Adequate clearances for servicing must be provided.
- The water heater should not be installed in the same room with a gas stove.
- When determining the floor clearance, a clearance of 6 inches must be maintained between the vent pipe and combustible material. A side wall clearance of 6 inches and a top clearance of 12 inches must be maintained.
- The vent pipe can be up to 32 ft. in length with one elbow.
- The vent pipe should be installed with a flame retardant wall thimble. Owner must refer to vent manufacturer's instructions and specifications. Eccotemp information can be found at [www.eccotemp.com](http://www.eccotemp.com), please refer to page 24 for additional links. Installation guidelines for venting provided by Eccotemp, who is solely responsible for venting installation accuracy.
- The power socket connecting the water heater should be grounded properly with a GFCI circuit protector.
- The water heater should not be located in an area where leakage of the heat exchanger or connections will result in damage to the area adjacent to it or to lower floors of the structure. When such areas cannot be avoided it is recommended that a suitable catch pan, adequately drained, must be installed under the water heater. The pan must not restrict combustion airflow.
- The water heater should be installed as close as practical to the vent termination to minimize vent length and the number of elbows required for venting.
- A gas fired water heater or any other appliance should not be installed in a space where liquids which give off flammable vapors are to be used or stored. Such liquids include gasoline, LPG (butane or propane), paint or adhesives and their thinners, solvents or removers.
- The water heater should be installed far from heat sources, flammable and dangerous materials. Because of natural air movement in a room or other enclosed space, flammable vapors can be carried some distance from where their liquids are being used or stored. The open flame of the water heater's main burner can ignite these vapors causing an explosion or fire which may result in severe burns, death or property damage.
- Raising the water heater will reduce, **BUT NOT** eliminate the possibility of lighting the vapor of any flammable liquids which may be improperly stored or accidentally spilled.

# INSTALLING THE 6GB WATER HEATER

## LOCATION

- If the water heater is installed in a garage, it should be installed so that the direct ignition system and main burner are no less than 18 inches above the garage floor.
- Hot and cold water lines should be insulated to conserve water and energy.
- The water heater must be located so it is not subject to physical damage, for example, by moving vehicles, area flooding, etc.
- The water heater should be installed with the proper venting materials and termination suitable for Category III venting. Failure to install and properly vent the water heater to the Indoors as outlined in the Venting Section of this manual can result in unsafe operation. Owner must refer to vent manufacturer's instructions and specifications. Eccotemp information can be found at [www.eccotemp.com](http://www.eccotemp.com), please refer to page 24 for additional links.
- For other than a direct vent appliance, the appliance must be located as close as possible to a chimney or gas vent.
- **DO NOT** install water heater where it will be subject to vibrations.
- **DO NOT** install water heater in Recreational Vehicles, Mobile Homes, Boats and other Watercraft.
- **DO NOT** install the water heater near vents for heating or cooling. A minimum of 4 ft. should be maintained.
- If the clearances stated on the Instruction/Warning Label, located on the front panel of the heater differ, install the water heater according to the clearances stated on the label.

**⚠ WARNING! Combustible construction refers to adjacent walls and ceilings and should not be confused with combustible or flammable products and materials. Combustible and/or flammable products and materials should never be stored in the vicinity of this or any gas appliance.**

## THE VENT FOR THIS APPLIANCE SHALL NOT TERMINATE:

Over public walkways; or

Near soffit vents or crawl space vents or other areas where condensate or vapor could create a nuisance or hazard or cause property damage; or

Where condensate vapor could cause damage or could be detrimental to the operation of regulators, relief valves, or other equipment.

## CORROSIVE ATMOSPHERES

The air in beauty shops, dry cleaning establishments, photo processing labs, and storage areas for liquid and powdered bleaches or swimming pool chemicals often contain halogenated hydrocarbons. An air supply containing halogenated hydrocarbons may be safe to breathe, but when it passes through a gas flame corrosive elements are released that will shorten the life of any gas burning appliance.

Propellants from common spray cans or gas leaks from A/C and refrigeration equipment are highly corrosive after passing through a flame. The water heater warranty is voided when failure of the water heater is due to operation in a corrosive atmosphere.

**⚠ NOTICE! The water heater should not be installed near any air supply containing halogenated hydrocarbons.**

# INSTALLING THE 6GB WATER HEATER

## COMBUSTION AND VENTILATION AIR

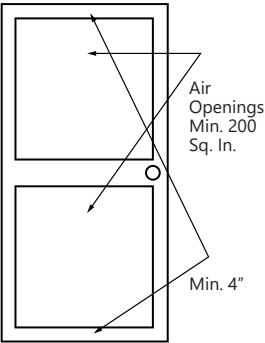

**Proper operation of the water heater requires air for combustion and ventilation. Provisions for combustion and ventilation air must comply with referenced codes and standards.**

A confined space is one having a volume of less than 50 cubic feet per 1,000 BTUH of the aggregate input of all appliances within that space.

The air must be supplied through two permanent openings of equal area. One is to be located within 12" above the floor and the other is to be located within 12" below the ceiling.

The minimum net free area of each opening must not be less than one square inch per 1,000 BTUH of the total input rating of all appliances in the enclosure (but not less than 100 square inches), if each opening communicates with other unconfined areas inside the building.

Buildings of unusually tight construction shall have the combustion and ventilation air supplied from Indoors, or a freely ventilated attic or crawl space. If air is supplied from Indoors, directly or through vertical ducts, there must be two openings located as specified above and each must have a minimum net free area of not less than one square inch per 4,000 BTUH of the total input rating of all the appliances in the enclosure.

If horizontal ducts are used to communicate with the Indoors, each opening must have a minimum net free area of not less than one square inch per 2,000 BTUH of the total input rating of all appliances in the enclosure. If ducts are used, the minimum dimensions of rectangular air ducts shall not be less than 4".

**⚠ NOTICE! If the water heater is installed in an unconfined space within a building of conventional frame, masonry or metal construction, infiltration air is normally adequate for proper combustion and ventilation. If the water heater is installed in a confined space, provisions for combustion and ventilation air must be made.**

**⚠ NOTICE! If the duct openings which supply combustion and ventilation air are to be covered with a protective screen or grill, the net free area (openings in the material) of the covering material must be used in determining the size of the openings. Protective screening for the openings MUST NOT be smaller than 1/4" mesh to prevent clogging by lint or other debris.**

## INSPECT SHIPMENT

Inspect the water heater for possible damage. Check the markings on the rating plate of the water heater to be certain the type of gas supplied corresponds to the water heater requirements verify all included parts are present (see below).



Wood Screw  
x 2 pcs.



Anchors  
x 2 pcs.



Expansion Screw  
x 2 pcs.



Gas Shut-Off  
Valve 1 pcs.

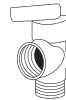

3/4" Pressure Relief  
Valve 1 pcs.  
(Included in Canada  
Shipments Only)



Use and Care  
Manual

PLEASE NOTE: 6GB IS FOR INDOOR PERMANENT INSTALLATIONS ONLY. THIS MANUAL AND ALL ECCOTEMP CONTENT IS SUBJECT TO CHANGE WITHOUT NOTICE. PLEASE VISIT [WWW.ECCOTEMP.COM/SUPPORT](http://WWW.ECCOTEMP.COM/SUPPORT) FOR MORE INFORMATION.

# INSTALLING THE 6GB WATER HEATER

## TYPICAL INSTALLATION

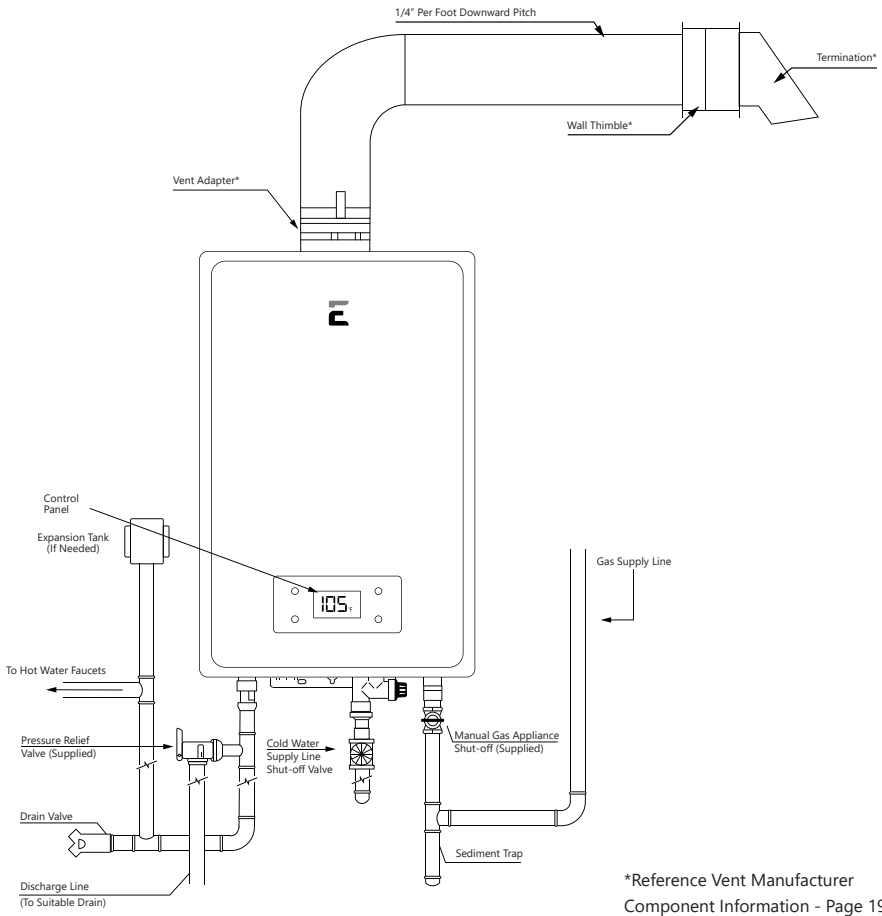

**⚠ NOTICE!** The National Fuel Gas Code (NFGC) mandates a manual gas shut-off valve: See NFGC for complete instructions. Local codes or plumbing authority requirements may vary from the instructions or diagrams provided and take precedent over these instructions.

# INSTALLING THE 6GB WATER HEATER

## WATER CONNECTION

Plumbing should be carried out by a qualified plumber in accordance with local codes. Use approved plumbing materials and tools only.

Install a Check Valve between the water heater and the water shut-off valve (see diagram below).

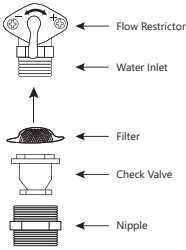

To conserve energy and to prevent freezing, insulate both cold and hot water supply lines. **DO NOT** cover the drain valves. Install a shut-off valve near the inlet of the water heater for service and draining purposes. Before connecting the water supply pipe to the water heater, open the shut-off valve and clean out sand, debris, air, caulking material, etc. inside the pipe. Connect to the water inlet, then check water flow. Close the shut-off valve and clean the water filter.

**If a water heater is installed in a closed water supply system, such as one having a backflow preventer in the cold water supply line, means shall be provided to control thermal expansion. Contact the water supplier for local plumbing inspector on how to control this situation.**

### **⚠ CAUTION! This water heater must only be used with the following water supply system conditions:**

- **With clean, potable water free of corrosive chemicals, sand, dirt, or other contaminants.**
- **With inlet water temperatures above 32°F, but not to exceed 90°F.**
- **Free of lime and scale deposits.**
- **DO NOT reverse the hot and cold water connections. The water heater will not operate.**

To ensure proper operation of the water heater, the following water pressure guidelines should be followed:

- Operation of the water heater requires the minimum water pressure of 14 psi and a minimum water flow rate of 0.8 gpm.
- Additional water pressure is required for long pipe runs and outlet fitting(s) water pressure drops.
- To maintain proper performance, ensure sufficient water supply pressure. The Required Water Pressure = Min. Operating Water Pressure (14 psi) + Pipe Pressure Loss + Faucet and Shower Pressure Loss + Safety Margin (more than 5 psi).
- To supply hot water to upper floors, additional water pressure (0.44 psi/ft) must be ensured. The measurement should be calculated by the distance between the water inlet of the water heater (ground level) to the hot water faucet (upper floor level).
- Well water systems should be set at a range of 50-60 psi.
- When the water is supplied from a water supply tank, the height of the tank and the diameter of the pipes and their relation to water pressure, should be taken into consideration. Gravity water pressure is not recommended.

**⚠ NOTICE!** If the water flow resistance of a shower head is too high, the burner in the water heater will fail to ignite. Keep the shower head clean from debris that could cause additional pressure drop.

**⚠ NOTICE!** If using mixing valves on the outlet, choose one which prevents cold water pressure from overcoming hot water line pressure.

**⚠ IMPORTANT! Do not apply heat to the HOT or COLD water connections. Any heat applied to the water supply fittings will permanently damage the internal components of the water heater.**

**DO NOT** use pipes with smaller diameters than the water supply connection of the water heater.

Be sure to connect the water inlet and the hot water outlet as shown on the water heater. If reversed, the water heater will not function.

Installation of unions or flexible copper connections are recommended on the HOT and COLD water lines, so that the water heater may disconnect easily for servicing if necessary.

PLEASE NOTE: 6GB IS FOR INDOOR PERMANENT INSTALLATIONS ONLY. THIS MANUAL AND ALL ECCOTEMP CONTENT IS SUBJECT TO CHANGE WITHOUT NOTICE. PLEASE VISIT [WWW.ECCOTEMP.COM/SUPPORT](http://WWW.ECCOTEMP.COM/SUPPORT) FOR MORE INFORMATION.

# INSTALLING THE 6GB WATER HEATER

## WATER CONNECTION

### In regards to the HOT WATER OUTLET:

- Connections between the water heater and point(s) of use should be as short and direct as possible.
- **DO NOT** use lead or non-approved plastic pipe.
- To conserve energy and minimize heat loss, insulation of hot water piping is recommended.

**⚠ NOTICE!** The flow rate of hot water may vary when more than two faucets (appliances, fixtures, etc.) are being used simultaneously.

**⚠ NOTICE!** The pipes **MUST** be completely drainable. If the hot water faucets are located at a point higher than the water heater, place a drain valve at the lowest point (see diagram to the left).

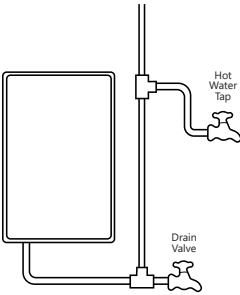

## GAS SUPPLY

**⚠ WARNING!** Do not attempt to convert this water heater for use with a different type of gas other than the type shown on the rating plate. Such conversion could result in hazardous operating conditions. Please have a professional connect the gas pipe.

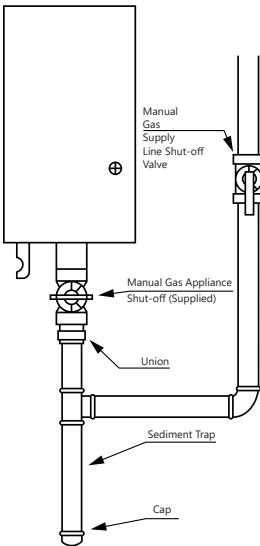

- The Manual Gas Appliance Shut-Off Valve must be installed at the gas connection of the water heater at the same time of installation (see diagram to the left).
- The branch gas supply line to the water heater should be clean black steel pipe or other approved gas piping material.
- A ground joint union or ANSI design certified semi-rigid or flexible gas appliance connector should be installed in the gas line close to the water heater.
- The National Fuel Gas Code (NFCG) mandates a manual gas shut-off valve: see (NFCG) for complete instructions.
- If flexible connectors are used, the maximum length shall not exceed 36".
- A sediment trap should be installed at the bottom of the gas line.
- The inlet gas pressure to the water heater must not exceed 10.5" w.c. for natural or 14" w.c. for LPG.
- For purposes of input adjustment, the minimum inlet gas pressure (with main burner on) is shown on the water heater rating plate. If high or low gas pressures are present, contact your gas supplier for correction.
- It is recommended that the minimum BTUs in the flex and gas lines be 1" black steel, flex rated at a minimum of 150,000 BTUs.
- If lever type gas shut-offs are used, they shall be T-Handle type.
- The water heater and its individual shut-off valve must be disconnected from the gas supply piping system during any pressure testing of that system at test pressure in excess of 1/2 psi (3.5 kPa).
- The water heater must be isolated from the gas supply piping system by closing its individual shut-off valve during pressure testing of the gas supply piping system at test pressures equal to or less than 1/2 psi (3.5 kPa).

**DO NOT** use excessive force (over 31.5 ft. lbs.) in tightening the pipe, particularly if pipe compound is used, as the water heater may be damaged.

Compound used on the threaded joints of the gas piping must be of the type resistant to the action of LPG.

Use compound sparingly and use on male threads only.

PLEASE NOTE: 6GB IS FOR INDOOR PERMANENT INSTALLATIONS ONLY. THIS MANUAL AND ALL ECCOTEMP CONTENT IS SUBJECT TO CHANGE WITHOUT NOTICE. PLEASE VISIT [WWW.ECCOTEMP.COM/SUPPORT](http://WWW.ECCOTEMP.COM/SUPPORT) FOR MORE INFORMATION.



# INSTALLING THE 6GB WATER HEATER

## RELIEF VALVE

A new pressure relief valve, complying with the Standard for relief Valves and Automatic Gas Shut-Off Devices for Hot Water Supply Systems, ANSI Z21.22, must be installed at the hot water outlet connection of the water heater at the time of installation. Local codes shall govern the installation of relief valves.

For safe operation of the water heater, be sure that:

- The pressure rating of the relief valve must not exceed 150 psi, the maximum working pressure of the water heater as marked on the rating plate.
- The BTUH rating of the relief valve must equal or exceed the BTUH input of the water heater as marked on its rating plate.
- No valve of any type should be installed between the relief valve and water heater.
- Discharge from the relief valve should be piped to a suitable drain to eliminate potential water damage. Piping used should be of a type approved for the distribution of hot water.
- Hot and Cold water lines should be insulated up to the water heater.
- The discharge line must be **NO SMALLER** than the outlet of the valve and must pitch downward to allow complete drainage (by gravity) of the relief valve and discharge line.
- The end of the discharge line should not be threaded or concealed and should be protected from freezing. No valve of any type, restriction or reducer coupling should be installed in discharge line.

**⚠ NOTICE!** The diagram below illustrates a pressure only relief valve. If local codes require a combination temperature and pressure relief valve be installed, an extension piece may be needed.

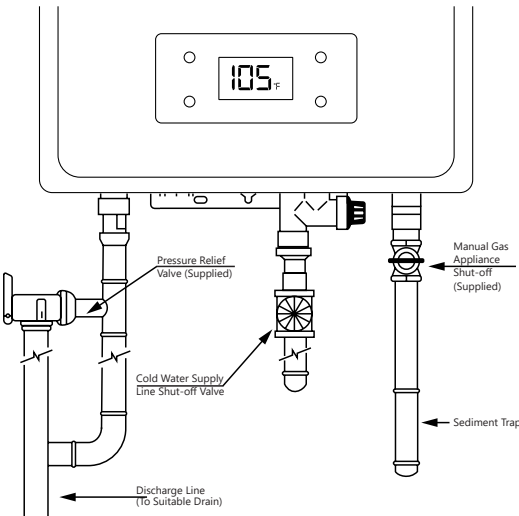

**⚠ NOTICE!** Local codes govern the installation of relief valves. If local codes require that a temperature and pressure relief valve should be installed the manufacturer recommends a type 40XL Watts T&P relief valve or an equivalent model be used.

**⚠ NOTICE!** Manual operation of relief valves should be performed at least once a year. Turn off the electrical power and gas shut-off valve. Lift and release lever on the relief valve and check the manual operation of the relief valve. You should take precaution to avoid contact with the hot water coming out of the relief valve and to prevent water damage.

**⚠ NOTICE!** If the relief valve on the system discharges periodically, this may be due to thermal expansion in a closed water supply system. Contact the water supplier or local plumbing inspector on how to correct this situation. Do not plug the relief valve.

PLEASE NOTE: 6GB IS FOR INDOOR PERMANENT INSTALLATIONS ONLY. THIS MANUAL AND ALL ECCOTEMP CONTENT IS SUBJECT TO CHANGE WITHOUT NOTICE. PLEASE VISIT [WWW.ECCOTEMP.COM/SUPPORT](http://WWW.ECCOTEMP.COM/SUPPORT) FOR MORE INFORMATION.

# INSTALLING THE 6GB WATER HEATER

## LEAK TESTING

**⚠ WARNING!** Never use an open flame to test for gas leaks, as property damage, personal injury, or death could result.

The water heater and its gas connections must be leak tested at normal operating pressures before it is placed in operation.

- Turn on the gas shut-off valve(s) to the water heater.
- Use a commercial leak detector or soapy water solution to test for leaks at all connections and fittings. Bubbles indicate a gas leak that must be corrected.

All connections should also be leak tested after the water heater is placed in operation.

## PRESSURE TESTING THE GAS SUPPLY SYSTEM

**⚠ WARNING!** Install a gas pressure regulator, in the gas supply line, which does not exceed the maximum supply pressure.

**DO NOT** use an individual type gas regulator.

The water heater must be isolated from the gas piping system by closing the manual gas shut-off valve during any pressure testing of the gas supply piping at pressures equal to or less than 1/2 psi (14" w.c.).

## HIGH ALTITUDE

The Eccotemp 6GB Builder Series Gas Tankless Water Heater has been tested for use at elevations up to 2000 ft. Installation and use of the Eccotemp 6GB above 2000 ft. may effect overall efficiency and performance.

## VENTING

The installation of venting must comply with national codes, local codes, and the vent manufacturer's instructions. Owner must refer to vent manufacturer's instructions and specifications. Eccotemp information can be found at [www.eccotemp.com](http://www.eccotemp.com), please refer to page 24 for additional links. The water heater must be vented to the indoors as described in these instructions. **DO NOT** connect this water heater to an existing vent or chimney, it must be vented separately from all other appliances. Eccotemp also recommends adding a backflow preventer to keep freezing outside air from reaching the water heater. Consult with an installation professional for proper installation. All vent components (adapters, pipe, elbows, terminals, etc.) should be UL 1738 Certified Stainless Steel Venting Material (e.g. AL29-4C). The specified vent termination must be used. The termination should be a 90° elbow type with screen (refer to page 24).

Use a vent pipe with an antidisconnection structure. The use of a high temperature silicone (500° F) may be required to seal vent connections. To prevent accidental gas exhaust leakage, apply a 1/4" wide bead approximately 1/4" from the end and another bead against the joint side of the stop bead.

Follow vent manufacturer's installation instructions. The water heater can be vented either horizontally or vertically. Vent pipe runs must be adequately supported along both horizontal and vertical runs.

The maximum recommended unsupported span should be no more than five (5) feet. Support isolation hanging bands should be used. **DO NOT** use wire (see diagram on page 19).

# INSTALLING THE 6GB WATER HEATER

## VENTING

The maximum recommended unsupported span should be no more than five (5) feet. Support isolation hanging bands should be used. **DO NOT** use wire (see diagram below).

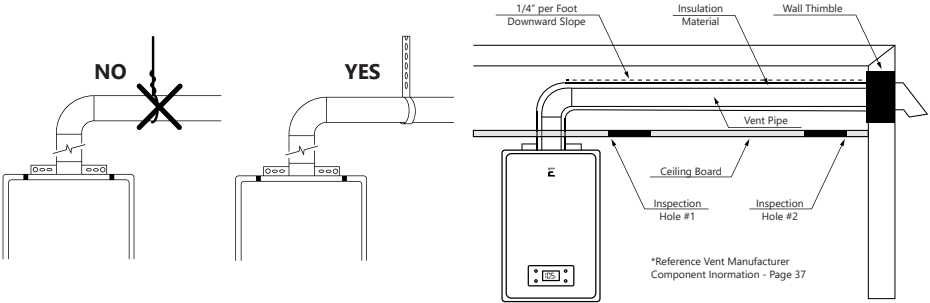

**⚠ DANGER!** Failure to install the vent adapter and properly vent the water heater to the indoors as outlined in the Venting section of this manual will result in unsafe operation of the water heater causing death, serious injury, explosion, or fire. To avoid risk of fire, explosion, or asphyxiation from carbon monoxide, **NEVER** operate the water heater unless it is properly vented and has adequate air supply for proper operation as outlined in the Venting section of this manual.

**⚠ WARNING!** Use UL approved Category III Stainless Steel vent material only. No other vent material is permitted. Owner must refer to vent manufacturer's instructions and specifications. Ecotemp information can be found at [www.ecotemp.com](http://www.ecotemp.com), see page 24 for additional links.

**⚠ WARNING!** Refer to page 24 for clearances to combustible material.

## VENTING THROUGH CLOSED SPACES

If the vent piping passes through a closed space, wrap the vent pipe with inflammable insulation material that is at least 3/4" thick. DO NOT let the insulation material make contact with flammable materials. A minimum clearance of 6" between the vent pipe and ceiling should be maintained. Follow local codes.

For maintenance and inspection purposes, the following holes are required to be made:

- Two (2) inspection openings that allow access to venting. One (1) of these openings should be close to where the vent pipe enters the ceiling. The other opening should never be near the vent termination.
- A ventilation hole with a 16 sq. in. opening should be made at least every 10 ft.

**⚠ NOTICE!** Vent pipes must be completely insulated with inflammable materials when installed in alcoves, closets, and garages and must not touch any flammable material.

# INSTALLING THE 6GB WATER HEATER

## MAXIMUM VENT LENGTH

Owner must refer to vent manufacturer's instructions and specifications. Eccotemp information can be found at [www.eccotemp.com](http://www.eccotemp.com) and on page 24.

Number of 90° elbows (bends)	Maximum Length of Straight Pipe
1	32'
2	27'
3	22'

**One (1) 90° Elbow is Equivalent to 5 ft. of Straight Pipe.**

The system will not operate if there is excessive restriction (pressure drop) in the venting system. A maximum of 32 ft. of vent pipe may be used provided there is only one 90° elbow in the system. If additional elbows are required: two elbows can be used with 27 ft., and three elbows can be used with 23 ft. of vent pipe.

A 90° elbow is equivalent to 5 ft. of straight pipe. A 45° elbow is equivalent to 2ft. 6 inches of straight pipe.

The termination elbow does not count as an elbow when determining total vent lengths.

The vent must be installed with a slight downward slope of 1/4" per ft. of horizontal run toward the vent terminal (see diagram below). This ensures that any condensate formed during operation is evacuated from the water heater.

A 1/4" per foot upward slope is acceptable when it is not possible to vent with a downward slope, however, a UL approved Category III Stainless Steel condensate trap MUST be installed at the beginning of the horizontal run (See PG. 19 "Typical Horizontal Termination w/ 1/4" per foot UPWARDS Slope" or PG. 24, "Standard Vertical Termination" for examples.)

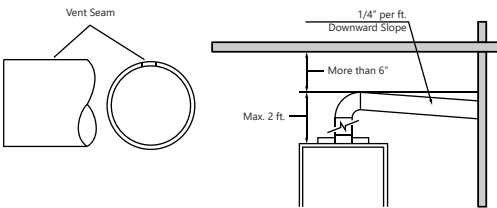

## MINIMUM VENT LENGTH

The venting may be as short as 12", provided one vent termination is installed to the outdoors through a sidewall, one 90° elbow is included in the installation, and the wall thimble is installed.

**⚠ NOTICE! Make sure that the seam of the vent pipe in horizontal runs is toward the top of the installation (see diagram to the left).**

## DRAINING THE CONDENSATE

In certain conditions, installations in unconditioned space or having long horizontal or vertical runs may accumulate condensate.

Condensate is known to be acidic; refer to local, state (provincial) or federal codes for proper handling methods.

In order to prevent condensate from draining back into the water heater, we recommend a condensate trap and drain to be installed in a horizontal vent section as close as practical to the water heater vent connection.

Not following proper condensate procedures will void warranty.

Eccotemp also recommends adding a backflow preventer to keep freezing outside air from reaching the water heater. Consult with an installation professional for proper installation.

PLEASE NOTE: 6GB IS FOR INDOOR PERMANENT INSTALLATIONS ONLY. THIS MANUAL AND ALL ECCOTEMP CONTENT IS SUBJECT TO CHANGE WITHOUT NOTICE. PLEASE VISIT [WWW.ECCOTEMP.COM/SUPPORT](http://WWW.ECCOTEMP.COM/SUPPORT) FOR MORE INFORMATION.

# INSTALLING THE 6GB WATER HEATER

## VENTING

### SPECIAL NOTES, REGULATIONS, AND CAUTIONS REGARDING VENTING

For Category II, III and IV water heaters, the venting system shall be installed in accordance with the water heater manufacturer's instructions and, if applicable, the venting system manufacturer's instructions. The 6GB is a Category III water heater. Please find detailed instructions for installation of the 6GB venting on pages 19-25.

The instructions for the installation of the venting system shall specify that the horizontal portions of the venting system shall be supported to prevent sagging; the methods of and intervals for support shall be specified. These instructions shall also specify that the venting system: for Category III and IV appliances, slope of a horizontal venting system shall be as specified in the appliance manufacturer's instructions; These instructions can be found on page 25.

If an appliance is marked, "Category III", the installation manuals shall specify the venting system to be used. When an existing Category III appliance is removed or replaced, the original venting system may no longer be sized to properly vent the attached appliances. Instructions shall also indicate effects of an improperly sized venting system (formation of condensate, leakage, spillage, etc.). All approved installation instructions for the 6GB venting can be found on pages 19-25.

Be sure to periodically clean the screens in the vent terminal where applicable.

Before you begin installation, ensure that you have a vent port available that will terminate at least 12 in. above the ground and at least 12 in. above normal amounts of snow. Please ensure that the vent termination point is clear of debris, blockages, and snow before using the 6GB.

# INSTALLING THE 6GB WATER HEATER

## VENTING

Vent Termination Clearances  
for Non-Direct Vent Installations in the US and Canada

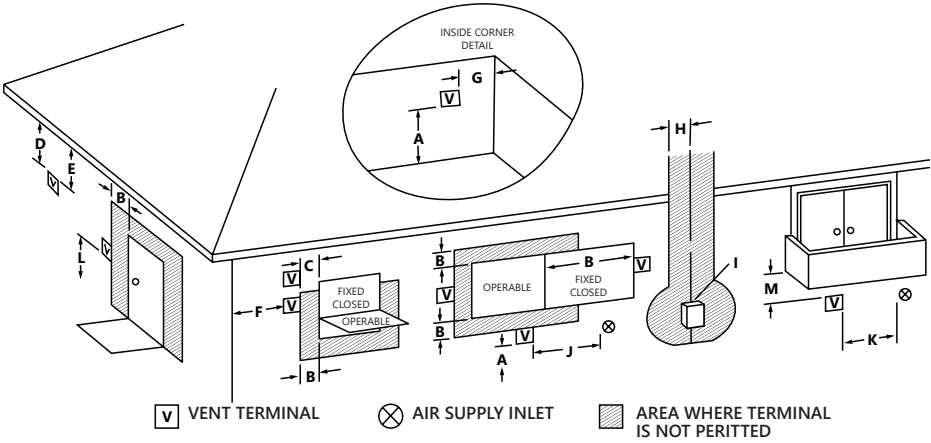

		US Installations	Canadian Installations
<b>A =</b>	Clearance above grade, veranda, porch, deck, or balcony.	12 in (30 cm)	12 in (30cm)
<b>B =</b>	Clearance to window or door that may be opened.	4 ft (1.2m) below or to the side of opening; 1 ft (300 mm) above opening.	6in (15cm) for appliances ≤ 10,000 BTUH (3 Kw), 12 in (30 cm) for appliances > 10,000 BTUH (3kW) and ≤ 100,000 BTUH (30kW), 36 in (91 cm) for appliance > 100,000 BTUH (30kW).
<b>C =</b>	Clearance to permanently closed window.	*	
<b>D =</b>	Vertical Clearance to ventilated soffit located above the terminal within a horizontal distance of 2 feet (61 cm) from the center line of the terminal.	*	
<b>E =</b>	Clearance to unventilated soffit.	*	

PLEASE NOTE: 6GB IS FOR INDOOR PERMANENT INSTALLATIONS ONLY. THIS MANUAL AND ALL ECCOTEMP CONTENT IS SUBJECT TO CHANGE WITHOUT NOTICE. PLEASE VISIT [WWW.ECCOTEMP.COM/SUPPORT](http://WWW.ECCOTEMP.COM/SUPPORT) FOR MORE INFORMATION.

# INSTALLING THE 6GB WATER HEATER

## VENTING

<b>F =</b>	Clearance to outside corner.	*	
<b>G =</b>	Clearance to inside corner.	*	
<b>H =</b>	Clearance to each side of center line extended above meter / regulator assembly.	*	3 ft (91 cm) within a height 15 ft above the meter / regulator assembly.
<b>I =</b>	Clearance to service regulator vent outlet.	*	3 ft (91 cm)
<b>J =</b>	Clearance to non mechanical air supply inlet to building or the combustion air inlet to any other appliance.	4 ft (1.2 m) below or to side of opening; 1 ft (300 mm) above opening.	6 in (15 cm) for appliances ≤ 10,000 BTUH (3kW), 12 in (30cm) for appliances > 10,000 BTUH (3kW) and ≤ 100,000 BTUH (30kW), 36 in (91 cm) for appliances > 100,000 BTUH (30kW).
<b>K =</b>	Clearance to a mechanical air supply inlet.	3 ft (91 cm) above if within 10 ft (3 cm) horizontally.	6 ft (1.83 m)
<b>L =</b>	Clearance above paved sidewalk or paved driveway located on public property.	*	7 ft (2.13 m)
<b>M =</b>	Clearance under veranda, porch, deck, or balcony.	*	12 in (30 cm)

\* For clearances not specified in ANSI Z=Z223.1 / NFPA 54 or CSA-B149.1, one of the following shall be indicated;

- A) A minimum clearance value determined by testing in accordance with Clause 5.20, or;
- B) A reference to the following footnote:

“Clearance in accordance with local installation codes and the requirements of the gas supplier.”

- A vent shall not terminate directly above a sidewalk or paved driveway that is located between two single family dwellings and serves both dwellings.
- Permitted only if veranda, porch, deck, or balcony is fully open on a minimum of two sides beneath the floor.

### Notes:

- **In accordance with the current CSA B149.1 Natural Gas and Propane Installation Code.**
- **In accordance with the current ANSI Z223.1 / NFPA 54 National Fuel Gas Code.**

# INSTALLING THE 6GB WATER HEATER

## VENTING

### VENTILATION PARTS

Owner must refer to vent manufacturer's instructions and specifications by visiting [www.eccotemp.com](http://www.eccotemp.com). Installation guidelines for venting is provided by Eccotemp, who is solely responsible for venting installation accuracy.

Eccotemp parts are available for purchase by visiting: [www.eccotemp.com](http://www.eccotemp.com)

Eccotemp Ventilation Parts: [www.eccotemp.com/installation](http://www.eccotemp.com/installation)

Part #	Description	Part #	Description
2ZVB04	Universal Adapter	2ZVEWD03	Horizontal Vent Kit
2SVSRPKE03	Vertical Vent Kit	2SVSWTF03	Horizontal Wall Thimble
2SVEEWCF	90 Elbow	2SVSWTEF03	Horizontal Wide Wall Thimble
2SVEEWCF0390	90 Termination Elbow	2SVEVWCF03	Vertical Drain Tee
2SVSTB04	Termination Box	2SVEVDP03	Horizontal Drain Pipe
2SVSHTX03	Termination Hood	2SVEPWCF	Vent Pipe

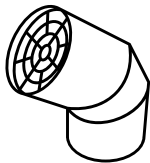

90° Termination Elbow  
Part #2SVEEWCF0390

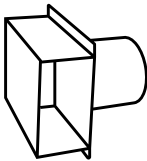

Termination Box  
Part #2SVSRTX04

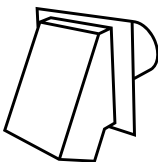

Termination Hood  
Part #2SVSHTX03

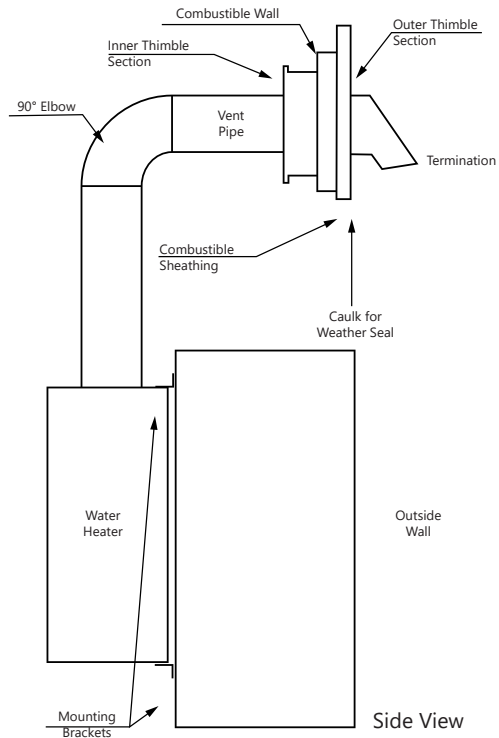

PLEASE NOTE: 6GB IS FOR INDOOR PERMANENT INSTALLATIONS ONLY. THIS MANUAL AND ALL ECCOTEMP CONTENT IS SUBJECT TO CHANGE WITHOUT NOTICE. PLEASE VISIT [WWW.ECCOTEMP.COM/SUPPORT](http://WWW.ECCOTEMP.COM/SUPPORT) FOR MORE INFORMATION.



# INSTALLING THE 6GB WATER HEATER

## VENTING

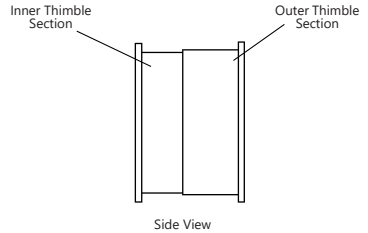
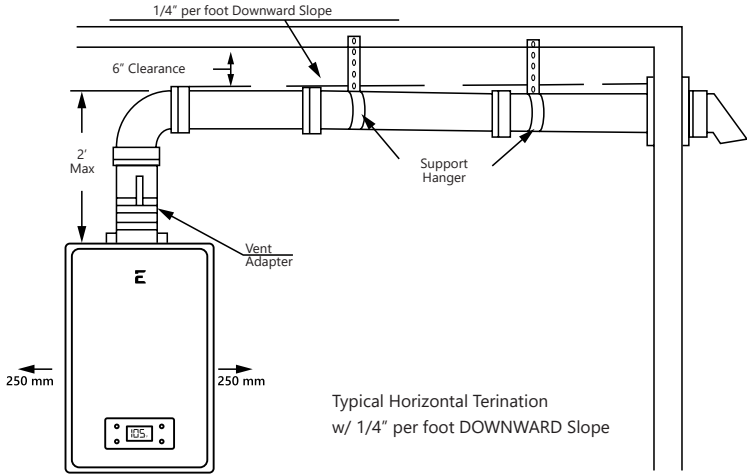

**⚠ WARNING!** Use UL approved Category III vent material only.

No other vent material is permitted.

Owner must refer to vent manufacturer's instructions and specifications. Eccotemp information can be found

at [www.eccotemp.com](http://www.eccotemp.com), refer to page 24 for additional links.

**⚠ CAUTION!** Follow the vent manufacturer's installation instructions as design might vary from manufacturer to manufacturer.

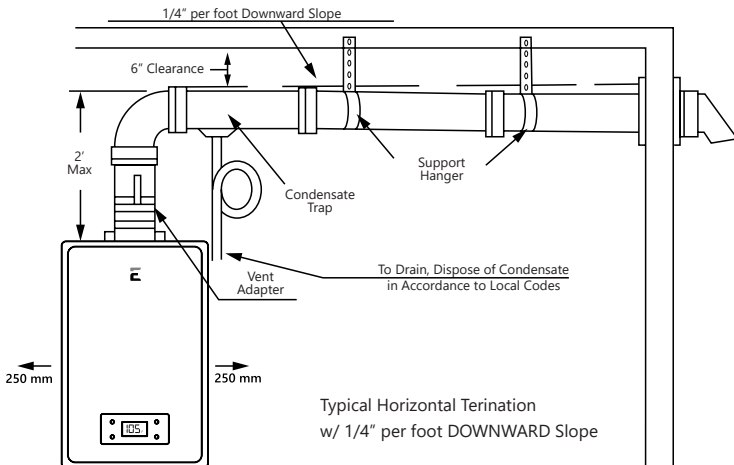

PLEASE NOTE: 6GB IS FOR INDOOR PERMANENT INSTALLATIONS ONLY. THIS MANUAL AND ALL ECCOTEMP CONTENT IS SUBJECT TO CHANGE WITHOUT NOTICE. PLEASE VISIT [WWW.ECCOTEMP.COM/SUPPORT](http://WWW.ECCOTEMP.COM/SUPPORT) FOR MORE INFORMATION.

# INSTALLING THE 6GB WATER HEATER

## ELECTRICAL CONNECTION

**⚠ WARNING!** Field wiring connections and electrical grounding must comply with local codes, or in the absence of local codes, with the latest edition of the National Electrical Code, ANSI/ NFPA 70, or in Canada, Canadian Electrical Code, CSA C22.1 Part 1.

### Electrical Connection & Power Cord:

- The electric power supply requirement for this water heater is 120 VAC / 60HZ, 2 AMPS.
- The water heater comes with a three (3) pin power supply cord. Use only a power outlet with a ground terminal.
- Do not cut the power cord!

#### **THIS WILL VOID THE WARRANTY!**

- The installation of an electric leakage breaker is recommended (GFCI).
- Keep an excess of the power supply cord on the outside of the water heater.

**⚠ WARNING!** Shock hazard line voltage is present. Before servicing the water heater, turn off the electrical power to the water heater at the main disconnect or circuit breaker. Failure to do so could result in severe personal injury or death.

**⚠ CAUTION!** Label all wires prior to disconnection when servicing controls. Wiring errors can cause improper and dangerous operation. Verify correct operation after servicing.

## ELECTRIC WIRING DIAGRAM

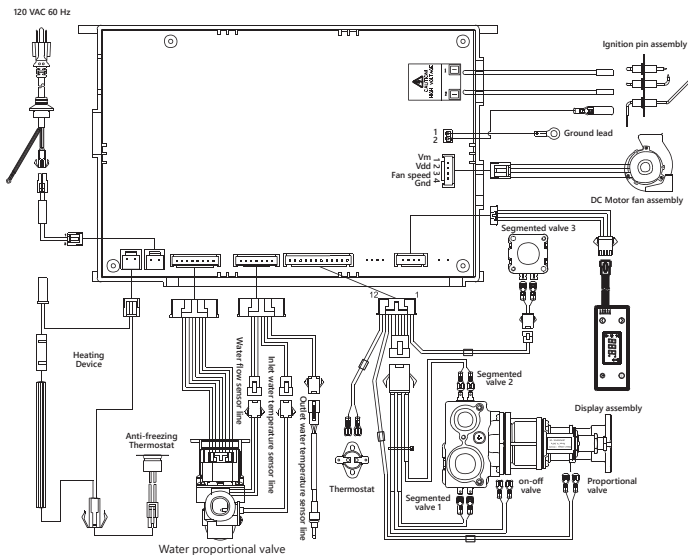

PLEASE NOTE: 6GB IS FOR INDOOR PERMANENT INSTALLATIONS ONLY. THIS MANUAL AND ALL ECCOTEMP CONTENT IS SUBJECT TO CHANGE WITHOUT NOTICE.  
PLEASE VISIT [WWW.ECCOTEMP.COM/SUPPORT](http://WWW.ECCOTEMP.COM/SUPPORT) FOR MORE INFORMATION.

# INSTALLING THE 6GB WATER HEATER

## INSULATION BLANKETS

Insulation blankets, available to the general public, for external use on gas water heaters are not necessary. The purpose of an insulation blanket is to reduce the standby heat loss encountered with storage tank heaters. This water heater does not store water making an insulation blanket unnecessary.

The manufacturer's warranty does not cover any damage or defect caused by installation, attachment or use of any

type of energy saving or other unapproved devices (other than those authorized by the manufacturer) into, onto or in conjunction with the water heater.

The use of unauthorized energy saving devices may shorten the life of the water heater and may endanger life and property.

The manufacturer disclaims any responsibility for such loss of injury resulting from the use of such unauthorized devices.

**⚠ WARNING! If local codes require external application of insulation blanket kits the manufacturer's instructions included with the kit must be carefully followed.**

## PIPE INSTALLATION

### Inlet Pipe and Outlet Pipe Installation

Use pressure resistant pipe to connect the inlet and the outlet water pipes of the water heater and the local water pipe (make sure to place the rubber ring). Before connecting the inlet water pipe, flush the inside of the pipe.

### Hot and Cold Pipe Insulation Installation

For increased energy efficiency, use pipe insulation. Please install the insulation, according to the illustrations above, making sure to insulate all the way to the top. Do not cover any drain or pressure valve(s).

**⚠ NOTICE! The hot and cold pipes should be insulated as shown help to provide additional freeze protection.**

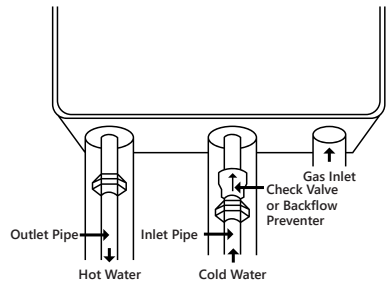
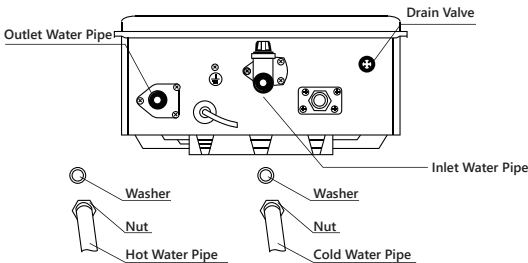

## DURING INSTALLATION OF THIS WATER HEATER

- DO** Check inlet gas pressure to ensure that it is within the range specified on the rating plate.
- DO** provide adequate air for combustion and ventilation as discussed in the Use and Care Manual and the National Gas Code (CAN/CGA B in Canada).
- DO** maintain proper clearances to combustibles as specified by applicable code.
- DO** ensure that the fuel terminal location complies with the guidelines found in the Use and Care Manual and National Fuel Gas Code (CAN/CGA B 149 in Canada).
- DO NOT** block or restrict air intake opening located on the back side of the water heater.
- DO NOT** remove the front cover unless absolutely necessary. This should only be done after being examined by a qualified service technician.
- DO NOT** install this product where standing water may occur.

PLEASE NOTE: 6GB IS FOR INDOOR PERMANENT INSTALLATIONS ONLY. THIS MANUAL AND ALL ECCOTEMP CONTENT IS SUBJECT TO CHANGE WITHOUT NOTICE. PLEASE VISIT [WWW.ECCOTEMP.COM/SUPPORT](http://WWW.ECCOTEMP.COM/SUPPORT) FOR MORE INFORMATION.

# INSTALLING THE 6GB WATER HEATER

## MOUNTING

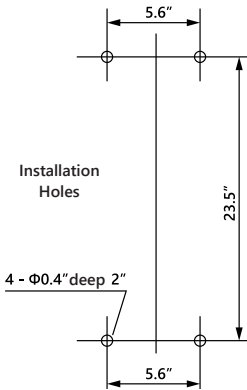

Make sure the location of the water heater allows for easy access and operation.

In case of dry wall or concrete wall use dry wall anchors or lag bolts.

The water heater requires 120VAC / 60Hz. Have a receptacle with ground terminal near the water heater. The length of the power supply cord is 5 ft.

Drill the holes as per the sizes in the figure to the left, put two (2) expansion screws into the top holes, and two (2) rubber screws into the bottom holes.

Hang up the water heater, tighten the expansion screws, and put two (2) wood thread screws into the bottom holes.

**⚠ CAUTION! Reinforcement of the wall is required in case the wall is not strong enough to hold the water heater.**

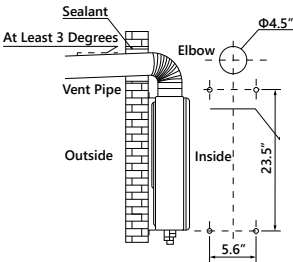

Back Installation

**Indoor water heater must be installed with a CAT 3 vent pipe in accordance with vent supplier / manufacturer in accordance with local code. Owner must refer to vent manufacturer's instructions and specifications. Ecotemp information can be found at [www.ecotemp.com](http://www.ecotemp.com), please refer to page 24 for additional links.**

### A. BACK INSTALLATION

1. Insert the vent pipe through the installation holes in the wall with the terminal sticking out.
2. Connect the elbow to the vent pipe and water heater, moving straight backwards until the expansion screws go into the holes of the water heater. Screw the nuts tight (pay attention to the direction of the elbow).

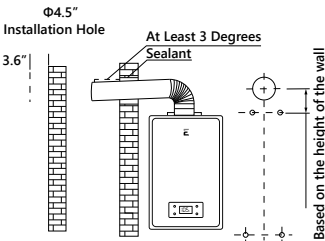

Side Installation

\*Reference Vent Manufacturer Component Information - Page 37

### B. SIDE INSTALLATION

1. Aim the holes in the water heater onto the expansion screws, hang it up and screw the nuts tightly.
2. Put the vent pipe through the holes in the wall, and connect the elbow with the water heater and vent pipe.

### C. VERTICAL INSTALLATION

1. Please refer to local installation professional or venting manufacturer.
2. The installation hole in the wall needs to be sealed by fire-retardant material or wall thimble, making sure the water heater is tight and will not come off.

# INSTALLING THE 6GB WATER HEATER

## INSTALLATION CHECK LIST

### Water heater location

- Installed indoors.
- Close to area of mostly used outlet.
- Protected from freezing temperatures.
- Proper clearance from combustible surfaces observed.
- Sufficient fresh air supply for proper operation of water heater.
- Air supply free of corrosive elements and flammable vapors.
- Provisions made to protect area from water damage.
- Sufficient room to service heater.
- Combustible materials, such as clothing, cleaning materials, rags, etc. clear of the heater and vent piping.
- Water heater is properly attached to the wall.
- Ensure a backflow preventer has been installed to the vent piping.
- Install a condensation trap and drain (as required).

### Water Supply

- Water supply has sufficient pressure.
- Air purged from water heater and piping.
- Water connections tight and free of leaks.
- Water filter is clean and in place.
- Materials are used as instructed in this manual.
- Water pipes are insulated.

### Gas Supply

- Gas type matches rating plate.
- Gas supply pressure is sufficient for the water heater.
- Gas line equipped with shut-off valve, union and sediment trap.
- Approved pipe joint compound used.
- Commercial leak detector or soap and water solution used to check all connections and fittings for possible gas leak.
- Gas company inspected installation (if required).
- It is recommended that the minimum BTUs in the flex and gas lines be 1" black steel, flex rated at a minimum of 199 BTUs.

### Relief Valve

- Pressure Relief Valve properly installed and discharge line run to open drain.
- Discharge line protected from freezing.

### Electrical Wiring

- Voltage matches rating plate.
- Water heater is properly grounded.
- Wiring meets all local codes.
- GFCI Protection where required.

# OPERATING INSTRUCTIONS

## START INSTRUCTIONS

Before operating this water heater, be sure to read and follow the instructions on the label pictured below and all other labels on the water heater, as well as the warnings printed in this manual. Failure to do so can result in unsafe operation of the water heater resulting in property damage, personal injury, or death. Should you have any problems reading or following the instructions in this manual. **STOP**, and get help from a qualified person.

## BEFORE USING THE WATER HEATER FOR YOUR SAFETY

**Warning:** If you do not follow these instructions exactly, A FIRE OR EXPLOSION MAY RESULT CAUSING PROPERTY DAMAGE, PERSONAL INJURY OR LOSS OF LIFE.



### FOR YOUR SAFETY

- Not to be used as a pool heater
  - Suitable only for outdoor installation
  - **DO NOT** operate this appliance before leak checking hoses and gas cylinder connection
  - To be installed on non-combustible base
1. This water heater does not have a pilot. It is equipped with an ignition device which automatically lights the burner. Do not try to light the burner by hand.
  2. **BEFORE OPERATING** smell all around the water heater area for gas. Be sure to smell next to the floor because some floor because some gas is heavier than air and will settle on the floor. Test all connections with a commercial leak detector or soapy water.

### WHAT TO DO IF YOU SMELL GAS:

- **DO NOT** try to light any appliance
  - **DO NOT** touch any electric switch
  - **DO NOT** use any phone in your building
  - Immediately call your gas supplier from a neighbor's phone
  - Follow the gas supplier's instructions
  - If you cannot reach your gas supplier or fire department **DO NOT** return to your home
  - **ONLY** return to your home once your gas supplier or fire department authorized it.
3. Use only your hand to push or turn the gas control knob. Never use tools. If the knob will not push in or turn by hand, don't try to repair it, call a qualified technician. Force or attempt to repair may result in a fire or explosions.
  4. **DO NOT** use this water heater if any part has been under water. Immediately call a qualified service technician to inspect the water heater and to replace any part of the control system and any gas control which has been under water.

## OPERATING INSTRUCTIONS

1. **STOP!** Read the safety information above on this label.
2. Turn off all electric power to the appliance.
3. Set the thermostat to lowest setting.
4. **DO NOT** attempt to light the burner by hand.
5. Turn the Gas Shut-Off Valve located on the outside of the unit clockwise  to the "OFF" position.
6. Wait five (5) minutes to clear out any gas. If you smell gas, **STOP!** Follow "B" in the safety information above on this label. If you don't smell gas, go to the next step.
7. Turn the Gas Shut-Off Valve located on the outside of unit counterclockwise  to the "ON" position.
8. Turn on all electric power to the appliance.
9. Set thermostat to desired setting.
10. If the appliance will not operate, follow the instructions "To Turn Off Gas To Appliance" and call your service technician or gas supplier.

GAS SHUT-OFF  
VALVE



OPEN



CLOSED

## TO TURN OFF GAS TO APPLIANCE

1. Turn off all electric power to the appliance if service is to be performed.
2. Turn the Gas Shut-Off Valve located on the outside of the unit clockwise  to the "OFF" position.

PLEASE NOTE: 6GB IS FOR INDOOR PERMANENT INSTALLATIONS ONLY. THIS MANUAL AND ALL ECCOTEMP CONTENT IS SUBJECT TO CHANGE WITHOUT NOTICE.  
PLEASE VISIT [WWW.ECCOTEMP.COM/SUPPORT](http://WWW.ECCOTEMP.COM/SUPPORT) FOR MORE INFORMATION.

# OPERATING INSTRUCTIONS

## START INSTRUCTIONS

### TURNING ON THE WATER HEATER

1. Make sure the gas type you will use is same as the type on the data plate.
2. Turn on the main gas valve, plug in the power cord (be sure the socket is well grounded), and press the "ON/OFF" button on the control panel. Set temperature to 120°F.
3. Turn on the faucet, and the fan will begin working. You will hear the ignition sound after a few seconds. The burner will ignite, and hot water will come out. If the burner is not ignited successfully, the ignition sound will last a few seconds. If the burner still fails to ignite, turn off the faucet and wait for 10-20 seconds, and repeat the above procedures.

For the first use and/or if the water heater has not been used for a considerable period of time, the repeat of the above procedures may be required, due to accumulated air inside the gas pipe.

## SAFETY PRECAUTIONS

If there is any difficulty in understanding or following the Operating Instructions or the Care and Cleaning section, It is required that a licensed professional perform the work.

- **DO** turn off manual gas shut-off valve if water heater has been subjected to over heating, fire, flood, physical damage or if the gas supply fails to shut-off.
- **DO NOT** turn on water heater unless water and gas supplies are fully opened.
- **DO NOT** turn on water heater if cold water supply shut-off valve is closed.
- **DO NOT** allow combustible materials such as newspaper, rags or mops to accumulate near water heater.
- **DO NOT** store or use gasoline or other flammable vapors and liquids, such as adhesives or paint thinner, in vicinity of this or any other appliance. If such flammables must be used, open doors and windows for ventilation, and all gas burning appliances in the vicinity should be shut-off including their pilot lights, to avoid vapors lighting.

## ECO MODE

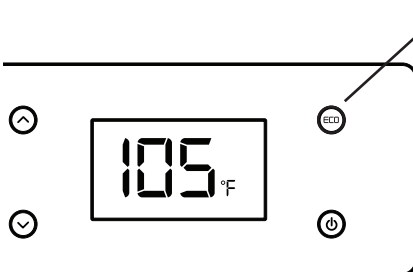

When using the Eco Mode feature, it sets the output temperature to a maximum of 104 degrees which cannot be adjusted while in Eco mode. Eco Mode reduces the BTU by up to 5% to save on gas consumption and energy costs. Simply press and hold the Eco Mode button down to activate this feature.

To adjust the temperature, you must turn Eco Mode "OFF".

# OPERATING INSTRUCTIONS

## WATER TEMPERATURE SETTING

Output temperature of water is regulated by setting the temperature on the front of the remote control.

Safety factors should be considered when selecting the water temperature setting of the water heater's remote control. The remote control was set at 110°F before the water heater was shipped from the factory. This is the recommended starting point. Water temperatures above 120°F can cause severe burns or death from scalding. The thermostat is adjusted to its lowest temperature position when shipped from the factory.

Be sure to read and follow the warnings outlined in this manual and on the label located on the water heater.

Mixing values are available for reducing point of use water temperature by mixing hot and cold water in branch water lines. Procedures for adjusting the thermostat for energy efficient operation at the minimum water temperature setting consistent with the consumer's needs. Contact a licensed plumber or the local plumbing authority for further information. See page 4 for details.

Time / Temperature Relationship in Scales	
Water Temperature	Time to Product a serious Burn
120	More than 5 minutes
125	1 1/2 to 2 minutes
130	About 30 seconds
135	About 10 seconds
140	Less than 5 seconds
145	Less than 3 seconds
150	About 1 1/2 seconds
155	About 1 second
Table courtesy of Shriners Burn Institute	

**⚠ DANGER! There is a hot water scald potential if the temperatur is set too high. Households with small children, disabled, or elderly persons may require a 120°F. or lower temperature setting to prevent contact with HOT water.**

## SET TEMPERATURE MEMORY:

1. This model can memorize and save the last set temperature on the remote control with "priority".
  2. If no remote control has "priority", the set temperature of the water heater will be the same as the set temperature of the remote control which starts the water heater.
- This water heater contains an electronically controlled thermostat. From the factory, the temperature range is between 90°F and 140°F.
  - The remote control is factory preset 110°F.
  - To turn the remote control ON or OFF, press the POWER button for more than 3 seconds.
  - To adjust the temperature to a required setting, in "priority" mode, press the UP or DOWN temperature button. Press and hold UP or DOWN to raise or lower the temperature continuously.
  - When the water heater is in use, the set temperature can increase to 122°F, but there is no limit to temperature decrease. To increase the temperature more than 122°F, the water will need to be shut off-first.
  - The display will read the set temperature if the water heater is not in use or there is no water flow. If the water heater is in use or has water flow, the display will read the actual temperature. To view the set temperature in this condition, press UP or DOWN and the set temperature will flash for 3 seconds.
  - The hottest temperature water will be at the hot water faucet closest to the water heater.
  - Always remember to test the water temperature with your hand before use and remember that hotter water increases risk of scald injury.
  - Always supervise young children or others who are incapacitated.
  - If the water heater has been subjected to fire, flood or physical damage, turn off the manual gas shut-off valve(s), and do not operate the water heater again until it has been checked by qualified personnel.

**⚠ NOTICE! If inlet water temperature is high, and set temperature is low, the actual temperature might be higher than the set temperature, and vice versa.**

**⚠ WARNING! Should overheating occur or the gas supply fail to shut-off, turn off the manual gas control valve to the water heater.**

**⚠ NOTICE! If the BATH control is turned on, the temperature setting on the MAIN control cannot be changed. The BATH control(s) will always have PRIORITY over the MAIN control.**

PLEASE NOTE: 6GB IS FOR INDOOR PERMANENT INSTALLATIONS ONLY. THIS MANUAL AND ALL ECCOTEMP CONTENT IS SUBJECT TO CHANGE WITHOUT NOTICE.  
PLEASE VISIT [WWW.ECCOTEMP.COM/SUPPORT](http://WWW.ECCOTEMP.COM/SUPPORT) FOR MORE INFORMATION.



# CARE AND CLEANING

## MAINTENANCE & HOUSEKEEPING

Output temperature of water is regulated by setting the temperature on the front of the remote control.

**⚠ DANGER!** Before manually operating the relief valve, make certain no one will be exposed to the danger of the hot water should be released into a drain to prevent injury or property damage.

Properly maintained, your water heater will provide years of dependable trouble-free service. It is recommended that a periodic inspection of the burner, relief valve, water filter and venting system should be made by service personnel qualified in gas appliance repair.

Inspect the area around the water heater to ensure a safe operating environment. Keep water heater area clear and free from combustible materials, gasoline, and other flammable vapors and liquids. Ensure the water heater has not been damaged. If damage or denting is present, contact a service personnel to verify proper operation.

**⚠ DANGER!** Hotter water increases the potential for Hot Water Scalds.

It is suggested that a routine preventative maintenance program be established and followed by the user.

Check for any abnormal sounds during normal operation of the water heater.

**⚠ DANGER!** Failure to perform the recommended Routine Preventative Maintenance can harm the proper operation of this water heater, which can cause carbon monoxide dangers, excessive hot water temperatures and other potentially hazardous conditions.

At least once a year, lift and release the lever handle on the pressure relief valve, located in the hot outlet piping of the water heater, to make certain the valve operates freely. Allow several gallons to flush through the discharge line to an open drain.

All piping should be checked for gas and/or water leaks. Refer to page 13 of this manual for instructions on leak testing.

The air intake and cold water supply filters should be cleared monthly. Refer to the "Housekeeping" section for further information.

Rapid closing of faucets or solenoid valves in automatic water using appliances can cause a banging noise heard in a water pipe. Strategically located risers in the water pipe system or water hammer arresting devices can be used to minimize the problem.

DO NOT operate the water heater if you feel something is wrong with it.

DO NOT allow children to operate or otherwise handle the water heater.

**⚠ NOTICE!** If the pressure relief valve on the hot water heater discharges periodically, this may be due to a problem in the water system. Contact the water supplier or your plumbing contractor on how to correct this. DO NOT plug or stopper the relief valve outlet.

**⚠ NOTICE!** After inspection, maintenance, and/or cleaning, ensure proper operation by turning on a hot water faucet.

## HOUSEKEEPING

### HOW TO CLEAN THE WATER FILTER:

1. Make sure the water heater is OFF and the electrical power supply has been disconnected.
2. Turn the water supply OFF to the heater.
3. Unscrew the water filter, and slide the filter out.
4. DO NOT tap the filter as it may deform and/or damage the filter.
5. To remove severe dust, use a soft brush and wash with running water.
6. Return the filter to the water heater and screw in the filter.
7. Turn the electrical power supply and cold water supply ON to the water heater. Repeat the above procedures.

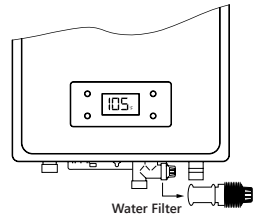

## 6 MONTH CLEANING ROUTINE

To prevent water scale, lime or rust deposit buildup and ensure your Eccotemp tankless water heater is running as efficiently as possible it is highly recommended that you clean your Eccotemp tankless water heater every 6 months. To do this we recommend that you use our Eccotemp EZ-Flush System Descaler Kit. For more information and to purchase please visit us at [www.eccotemp.com](http://www.eccotemp.com) or call 1-866-356-1992.

PLEASE NOTE: 6GB IS FOR INDOOR PERMANENT INSTALLATIONS ONLY. THIS MANUAL AND ALL ECCOTEMP CONTENT IS SUBJECT TO CHANGE WITHOUT NOTICE. PLEASE VISIT [WWW.ECCOTEMP.COM/SUPPORT](http://WWW.ECCOTEMP.COM/SUPPORT) FOR MORE INFORMATION.

# CARE AND CLEANING

## HOUSEKEEPING

Before performing any Housekeeping tasks to this water heater, be sure to turn the water heater off and disconnect the power supply.

Vacuum around the water heater for dust, dirt and lint on a regular basis. Clean the water heater and remote control by using a damp soft cloth with a few drops of mild detergent and gently wiping the surfaces of the water heater. Wipe any remaining moisture with a dry soft cloth.

To ensure sufficient ventilation and combustion air supply, proper clearances must be maintained. The water filters should be cleaned on a monthly basis. Combustion system is fan-assisted.

## CLEANING THE WATER HEATER AND REMOTE CONTROL(S):

- Make sure the water heater is **OFF** and the electrical power supply has been disconnected.
- **DO NOT** scrub the appliance with a brush.
- Use only mild soapy water, other cleaners may damage the surface of the water heater.
- **DO NOT** remove any label including the rating plate while cleaning or servicing.
- **DO NOT** splash water on the remote controls when cleaning.

**⚠ DANGER! Shock Hazard. Make sure the electrical power to the water heater is off to avoid potential serious injury or damage to components.**

**⚠ DANGER! Combustible materials, such as clothing, cleaning materials, or flammable liquids, etc., must not be placed against or next to the water heater.**

## VACATION AND EXTENDED SHUT-DOWN

If the water heater is to remain idle for an extended period of time, the power and water to the appliance should be turned off. If there is no power to the water heater, freeze protection does NOT work.

The water heater and piping should be drained if they might be subjected to freezing temperatures. When freezing temps persists consult with a license installation professional for winterization of your product.

During power outages built in freeze protection will not be activated. Take proper steps to ensure your water heater doesn't freeze.

After a long shut-down period, the water heater's operation and controls should be checked by a qualified service personnel.

## ANTI-FREEZING

**While the Anti-Freezers will help to protect from cold temperatures, they will in no way guarantee protection from freeze damage. Freezing temperatures occur at 32°F (0°C) DO NOT rely on the Anti-Freezers to fully protect the water heater from freezing, take all precautions to prevent cold damage.**

**\*Freezing anywhere in the plumbing system can result in damage to the water heater, such as a rupture in your Heat Exchanger. All pipes must be adequately protected from freezing.**

**⚠ NOTICE! The anti-freezing device works for the water heater only, and not for the inlet and outlet water pipes.**

Water heaters with Anti-Freezers have an automatic heating device and will help to avoid freeze damage, but the power must be kept on. Freezing will occur with no power. In very cold areas and when the temperature is under 32°F, or in event of an ice storm, freezing will occur as the heating power limit is exceeded. If these conditions take place, please follow the procedures explained below.

**⚠ NOTICE! When freezing temps persists consult with a license installation professional for winterization of your product.**

**⚠ NOTICE! Eccotemp recommends all termination hoods have a backflow preventer to assist with freezing air. Consult with an installation professional for proper installation.**

**⚠ NOTICE! During power outages built in freeze protection will not be activated. Take proper steps to ensure your water heater doesn't freeze.**

# CARE AND CLEANING OF THE WATER HEATER

## DRAINING PROCEDURE FOR THE 6GB

When the temperature falls below 32°F, water in your plumbing system or water heater can turn to ice and then expand causing damage to the water heater. This damage is not covered under your manufacturer's warranty. If these conditions are anticipated, please drain the water heater as follows to help but not guarantee from freezing:

1. Shut off the main gas valve and power.
2. Shut off the inlet water valve.
3. Open all faucets.
4. Take off the drain valve, and allow water to drain for 3 minutes or until the water heater is empty.
5. Making sure all water is out, replace the drain valve, and shut off the faucets.

## BELOW ARE INSTRUCTIONS FOR DRAINING WATER OUT OF THE WATER HEATER:

1. Turn off the water heater by pressing the power button on the front.
2. Close the gas shut-off valve(s).
3. Close the water shut-off valve.
4. Turn the on/off switch to the **OFF** position and disconnect breaker at least 10 seconds after step #1.
5. Open drain valve.
6. Open all hot water faucets. Before proceeding to the next step, make sure that **COLD** water is coming out of all hot water faucets.
7. To put the water heater back into operation after draining, follow the steps below.
8. Reinstall the water filter. Close the hot water outlet drain valve.
9. Open the water shut-off valve and close again after making sure that water comes out from hot water faucets (This step is to remove air from the water lines).
10. Reconnect the breaker and turn the on/off switch to the **ON** position, fully open the gas shut-off valve and the water shut-off valve.

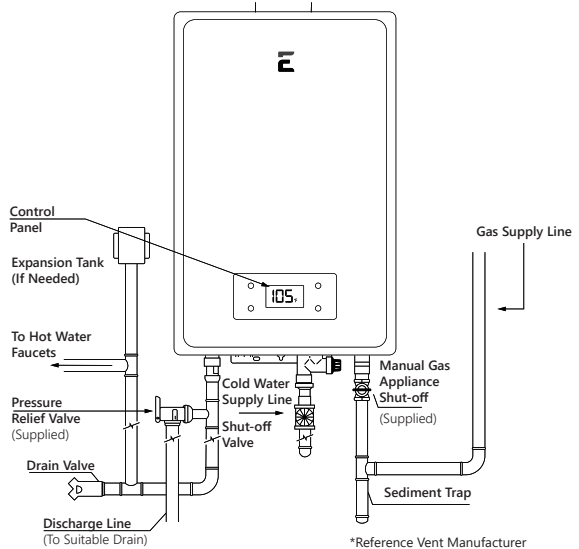

\*Reference Vent Manufacturer Component Information - Page 19-25

**⚠ NOTICE!** The water heater may not operate unless the above procedure is followed correctly.

**⚠ WARNING!** Failure to follow these instructions while draining the water heater can cause serious damage to the water heater as well as personal injury including scalding.

# TROUBLESHOOTING

## BEFORE YOU CALL FOR SERVICE

Save time and money! Review the charts on the following pages first and you may not need to call for service.

This water heater incorporates a variety of shut-off devices that prevents the operation of the water heater down if undesirable combustion condition occurs. Such as the presence of a blockage of the combustion air vent insufficient gas of pressure which can impact the safe operation of the water heater. Please contact a Qualified Service Technician if this occurs.

Temperature And Amount Of Hot Water	
Problem	Possible Solutions
The water is not hot enough.	<ol style="list-style-type: none"> <li>1. Check cross plumbing between cold and hot water lines.</li> <li>2. Is the gas supply valve fully open?</li> <li>3. Is the gas line sized properly?</li> <li>4. Is the gas supply pressure enough?</li> <li>5. Is the set temperature set too low?</li> </ol>
The water is too hot.	Is the set temperature set too high?
The hot water is not available when a fixture is opened.	<ol style="list-style-type: none"> <li>1. Make sure the unit has 110v 60hz power supply.</li> <li>2. If you are using the remote controller, is the power button turned on?</li> <li>3. Is the gas supply valve fully open?</li> <li>4. Is the water supply valve fully open?</li> <li>5. Is the filter on cold water inlet clean?</li> <li>6. Is there enough LPG in the bottle? (For propane)</li> </ol>
The hot water gets cold and stays cold.	<ol style="list-style-type: none"> <li>1. Is the flow rate enough to keep the water heater running?</li> <li>2. Is the gas supply valve fully open?</li> <li>3. Is the filter on cold water inlet clean?</li> <li>4. Are the fixtures clean of debris and obstructions?</li> </ol>
Fluctuation in hot water temperature.	<ol style="list-style-type: none"> <li>1. Is the filter on cold water inlet clean?</li> <li>2. Is the gas line sized properly?</li> <li>3. Is the supply gas pressure enough?</li> <li>4. Check for cross connection between cold water lines and hot water lines</li> </ol>
It takes a long tome to get hot water at the fixtures.	<p>The time it takes to delvier hot water from the water heater to your fixtures depends on the length of piping between the two.</p> <p>The longer the distance or the larger the pipes, the longer it will take to get hot water.</p>
The fan motor is still spinning after operation has stopped.	This normal. After operation has stopped, the fan motor keep running 15 - 75 seconds in order to reignite quickly, as well as push all exhaust gas out ofthe flue.
Remote Controller	
Problem	Possible Solutions
Remote controller does not display anything when the power button is turned on.	<p>Press the button, If the light does not light up?</p> <ol style="list-style-type: none"> <li>1. Make sure the unit has power.</li> <li>2. Make sure the connection to the unit is correct.</li> </ol>
An error code is displayed.	Please see page 37.
Remote controller can not change the set temperature.	Is power light flashing? If it is not, locate priority controller and turn and turn-off, or wait for 15 minutes on inactivity.

PLEASE NOTE: 6GB IS FOR INDOOR PERMANENT INSTALLATIONS ONLY. THIS MANUAL AND ALL ECCOTEMP CONTENT IS SUBJECT TO CHANGE WITHOUT NOTICE. PLEASE VISIT [WWW.ECCOTEMP.COM/SUPPORT](http://WWW.ECCOTEMP.COM/SUPPORT) FOR MORE INFORMATION.

# TROUBLESHOOTING

## ERROR CODE GUIDE

### When an error code is displayed:

- The water heater will alarm you with continuous “beep”.
- Close the hot water faucet, turn off the water heater by pressing the power button on the front.
- Wait for about 5 minutes before turning the water heater on, then open the hot water faucet.

**⚠ NOTICE! If an error code other than those listed below is displayed, immediately turn off the hot water faucet, take note of the error code, turn off the switch on the remote control and call the customer assistance number.**

### If the error code remains shown:

- Close the hot water faucet, turn off the water heater by pressing the power button on the front.
- Take the proper action shown below and attempt operation of the water heater again.

### If the error code is still shown:

- Close the hot water faucet, turn off the water heater by pressing the power button on the front.
- Take note of the error code displayed and call the customer service assistance number in the “If You Need Service.”

Error Code	Error Description	Possible Cause	What To Do
E0	Hot water sensor failure.	Junction port loose, Short circuit	Call for Service
E1	Ignition system failure.	The gas valve is not opened or fully opened, Water shut-off valve is not open, Junction port loose.	Check and open gas fully, Check and open water valve, Call for service
E2	There is flame when no water is coming in.	Electric circuit problem	Call for Service
E3	Over-heating protection.	Dry Combustion, Problem of overheating controller	Call for Service
E4	Cold water temperature sensor.	Problem with sensor, Problem with sensor's plug or socket, None of the above	Replace the sensor, Fix it, Replace the computer board
E5	Pressure Switch	Motor problem, Voltage of power supply is too low	Call for Service
E6	Over-Heating	Gas pressure is too high, Water shut-off valve is not fully opened, The temperature is set too low	Check shut-off valve and open fully, Increase temperature setting
E7	Solenoid Valve	Open circuit of the valve, Short circuit of the valve, None of the above	Connect the valve, Replace the valve, Replace the computer board
E8	Vent Pipe Block	Vent pipe is blocked	Clean the pipe
EN	The set shut-down time has been reached.		

**⚠ CAUTION! For your safety DO NOT attempt repair of gas piping, remote control, burners, vent connectors or other safety devices. Refer repairs to qualified service personnel.**

**⚠ CAUTION! Make certain power to water heater is “OFF” before removing protective cover FOR ANY REASON.**

**⚠ CAUTION! Label all wires prior to disconnection when servicing controls. Wiring errors can cause improper and dangerous operation. VERIFY PROPER OPERATION AFTER SERVICING.**

PLEASE NOTE: 6GB IS FOR INDOOR PERMANENT INSTALLATIONS ONLY. THIS MANUAL AND ALL ECCOTEMP CONTENT IS SUBJECT TO CHANGE WITHOUT NOTICE. PLEASE VISIT [WWW.ECCOTEMP.COM/SUPPORT](http://WWW.ECCOTEMP.COM/SUPPORT) FOR MORE INFORMATION.

# TROUBLESHOOTING

## PARTS LIST 6GB

### Instructions for placing a parts order:

Address parts order to the distributor or store from where the water heater was purchased.

All parts orders should include:

- The model and serial number of the water heater from the rating plate.
- Specify type of gas NG or LPG as marked on the rating plate.
- Part description (as noted below) and number of parts desired.

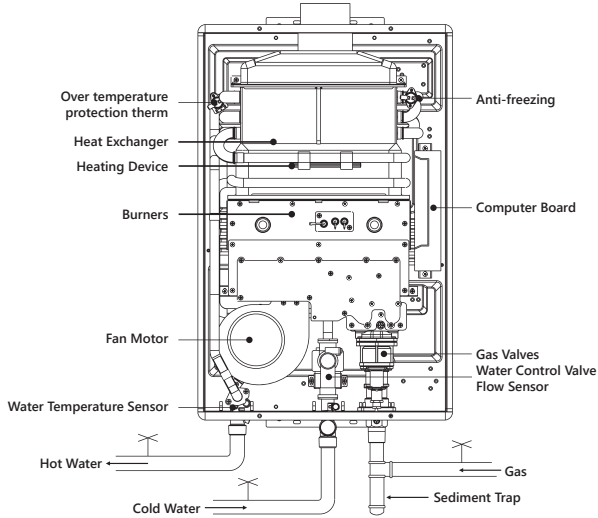

**⚠ NOTICE!** The Anti-Freezer and its thermostat are for the Indoor water heater, the indoor water heater has the Anti-freeze function only.

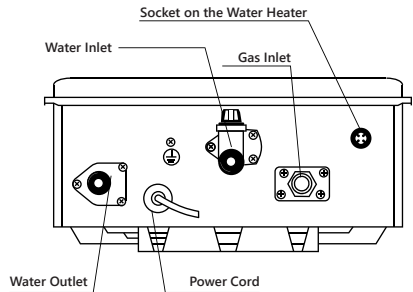
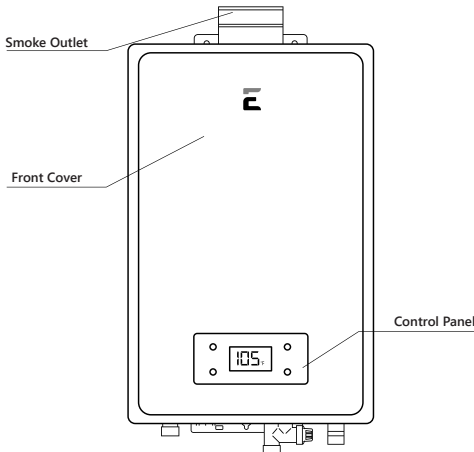

**⚠ CAUTION!** For your safety, DO NOT attempt repair of electrical wiring, gas.

PLEASE NOTE: 6GB IS FOR INDOOR PERMANENT INSTALLATIONS ONLY. THIS MANUAL AND ALL ECCOTEMP CONTENT IS SUBJECT TO CHANGE WITHOUT NOTICE. PLEASE VISIT [WWW.ECCOTEMP.COM/SUPPORT](http://WWW.ECCOTEMP.COM/SUPPORT) FOR MORE INFORMATION.

# Eccotemp Systems, LLC

## Limited Warranty Information

### MODEL (S): 6GB SERIES: 6GB-ILP/6GB-ING WHOLE HOME TANKLESS WATER HEATER

#### I. LIMITED WARRANTY

Subject to the terms below, Eccotemp Systems, LLC ("Eccotemp") provides this limited warranty (the "Limited Warranty") to cover the following Products and Covered Components:

PRODUCT NAME	COVERED COMPONENTS
6GB Series: 6GB-ILP/6GB-ING Whole Home Tankless Water Heater.	6GB Series: 6GB-ILP/6GB-ING Whole Home Tankless Water Heater: CSA certified fittings, accessories, and mounting hardware

This Limited Warranty is being provided to the original purchaser and subsequent owners (the "Owner"), but only while the Product remains as the site of the original installation.

#### II. LIMITED WARRANTY PERIOD

The term of this Limited Warranty (the "Warranty Period") begins on the date of purchase and ends as set forth below:

##### 2 YEAR WARRANTY

The covered components, except for the Heat Element, in the Product are warranted by Eccotemp for a period of two (2) years from the date of purchase when installed according to Eccotemp's Installation and Operating Instructions.

##### 3 YEAR WARRANTY

The Heat Element in the Product is warranted by Eccotemp for a period of three (3) years from the date of purchase when installed according to Eccotemp's Installation and Operating Instructions.

##### 30 DAY WARRANTY

All accessories that have been provided with the Product at no cost are warranted by Eccotemp for a period of thirty (30) days from the date of purchase when installed according to Eccotemp's Installation and Operating Instructions.

#### III. WARRANTY COVERAGE

If, during the Warranty Period, a component in the Product fails because of a manufacturing defect, Eccotemp will repair, replace, or refund the Product to the Owner at Eccotemp's sole discretion and as determined to be appropriate by the Eccotemp Support Team. As set forth in Section IV, the Owner may be responsible for all shipping, freight, and handling charges, as well as all fees and costs associated with the warranty service, including, but not limited to, all labor and other costs involved in diagnostic calls or in removing, repairing, servicing, or replacing any component. Eccotemp's sole responsibility under this Limited Warranty is to repair, replace, or refund the cost of the Product at Eccotemp's sole discretion. In the event that an exact replacement component is no longer available, Eccotemp will, at its option, provide a substitute component that Eccotemp deems suitable for the Product. If the Owner reports a subsequent issue with any covered component in the Product, the Owner may be responsible for retaining the failed component(s) for 90 days after a warranty claim is filed and must surrender the component(s) at the request of Eccotemp.

Both Eccotemp and the Owner of the Product are bound by this Limited Warranty.

#### IV. MAKING A WARRANTY CLAIM

To make a warranty claim through this Limited Warranty, the Owner must contact Eccotemp's Customer Service team at support@eccotemp.com, schedule a call or live chat on the Eccotemp support page at <http://support.eccotemp.com>. It is within Eccotemp's sole discretion when a repair, replacement, or refund will be issued. Any return for refund must be approved by Eccotemp's Customer Service team prior to shipping the Product back to Eccotemp. Please refer to Returning Your Product For Repair or Refund Policy provided with the Product.

Within the first 45 days of purchase, Eccotemp will cover all ground shipping costs for warranty related issues in the US and Canada, excluding Alaska, Hawaii and any location outside of the continental US and Canada. After the first 45 days of purchase, the Owner is responsible for all shipping to Eccotemp, regardless of reason or circumstance. Eccotemp will cover the warranty related shipping costs when returning the Product to the Owner after repair/inspection. The method for warranty related shipping will be ground equivalent with the provider within Eccotemp's sole discretion.

What information you will need for processing of your warranty claim:

- Proof of purchase
- Serial number
- Photos of the installation
- Photos of the damage point (if there is one)

All shipments of any type of product coming to Eccotemp for any reason must have a Return Goods Authorization ("RGA") number for any repairs to be made. Please contact Eccotemp to obtain an RGA number prior to shipping anything to Eccotemp. Failure to do so could result in loss of Product. Eccotemp will not be responsible for replacement due to loss or damage if these steps are not properly followed.

Any returns to Eccotemp must be sent in the original packaging. If your returned product does not have the original packaging and/or is missing any of the components that came with the product, there will be a nonnegotiable 15% restock fee.

PLEASE NOTE: 6GB IS FOR INDOOR PERMANENT INSTALLATIONS ONLY. THIS MANUAL AND ALL ECCOTEMP CONTENT IS SUBJECT TO CHANGE WITHOUT NOTICE.  
PLEASE VISIT [WWW.ECCOTEMP.COM/SUPPORT](http://WWW.ECCOTEMP.COM/SUPPORT) FOR MORE INFORMATION.

# Eccotemp Systems, LLC

## Limited Warranty Information

### MODEL (S): 6GB SERIES: 6GB-ILP/6GB-ING WHOLE HOME TANKLESS WATER HEATER

#### V. DISCLAIMER OF WARRANTIES AND RESPONSIBILITY FOR DAMAGES

EXCEPT AS PROVIDED IN THIS LIMITED WARRANTY, ECCOTEMP MAKES NO WARRANTY, EXPRESS OR IMPLIED, TO ANYONE AS TO FITNESS FOR ANY PURPOSE, MERCHANTABILITY, DESIGN, CONDITION, CAPACITY, PERFORMANCE, OR ANY OTHER ASPECT OF THE PRODUCT OR ITS MATERIAL OR WORKMANSHIP. ALL IMPLIED WARRANTIES WHICH MAY EXIST, NOT WITHSTANDING THIS DISCLAIMER, ARE LIMITED TO THE DURATION OF THIS LIMITED WARRANTY. THIS LIMITED WARRANTY IS MADE IN LIEU OF ALL OTHER GUARANTEES, WARRANTIES, REPRESENTATIONS, CONDITIONS, OBLIGATIONS, OR LIABILITIES, EXPRESS OR IMPLIED.

ECCOTEMP SHALL NOT BE LIABLE, EITHER IN CONTRACT OR TORT, FOR ANY DIRECT, INDIRECT, INCIDENTAL OR CONSEQUENTIAL DAMAGES, OR ANY LOSS, DAMAGE, OR INJURY TO PERSONS, INCLUDING DEATH, PROPERTY, OR THINGS, OR FOR DAMAGES OF ANY KIND OR NATURE INCLUDING BUSINESS INTERRUPTION, INCONVENIENCE OR LOSS OF ANTICIPATED PROFITS OR SAVINGS OCCASIONED BY OR ARISING OUT OF THE USE, MISUSE, NON-USE, REPAIR, REPLACEMENT OR DELAY IN DELIVERY OF THE PRODUCT. ECCOTEMP SHALL NOT BE LIABLE FOR THE COST OF ANY WORK DONE BY PURCHASER OR OTHERS TO THE PRODUCT.

This Limited Warranty gives specific legal rights. Some jurisdictions do not allow the exclusion or limitation of implied warranties or incidental or consequential damages. In such jurisdictions, the limitations or exclusions do not apply to the Owner. The Owner may also have other rights that may vary by jurisdiction.

#### VI. EXCLUSIONS

The following exclusions apply to this Limited Warranty:

1. A repair, replacement, or refund will not be provided under this Limited Warranty unless the Product containing the defective component is properly installed and maintained according to Eccotemp's Installation Manual and Use & Care Manual and in compliance with all applicable federal, state/province, and local laws, regulations, codes, policies, and licensing requirements. Any abuse, misuse, alteration, neglect, or misapplication of the Product will render this Limited Warranty null and void.
2. A repair, replacement, or refund will not be provided if the Product is damaged by services performed by third party service providers other than Eccotemp Systems.
3. Eccotemp systems is not responsible for any expenses arising from labor services, including but not limited to, installation or removal services due to a warranty claim.
4. A repair, replacement, or refund will not be provided if the Product is used in a hot water circulation loop, in series with a circulation system, where an on-demand recirculation system is incorporated, or in any other corrosive or otherwise destructive environment where the Product is not intended to be used as set forth in Eccotemp's Installation Manual and Use & Care Manual.
5. A repair, replacement, or refund will not be provided if the Product is damaged as a result of improper installation, including improper ventilation materials, sizing, length, elevation, condensation drainage, or inadequate airflow.
6. A repair, replacement, or refund will not be provided if the Product is damaged as a result of improper use, including freezing within the unit or surrounding piping, incorrect sizing for the application, scale build up, or incorrect gas and/or water pressure.
7. This Product shall not be used as a pool or spa heater. Use of the Product as a pool or spa heater shall be considered misuse and will render this Limited Warranty null and void.
8. A repair, replacement, or refund will not be provided if the Product is damaged by the use of non-potable, untreated or poorly treated well water, or water with high PH levels or hardness levels in excess of 12 grains per gallon (200 mg/L).
9. A repair, replacement, or refund will not be provided under this Limited Warranty if the original serial number on the Product has been removed or altered in a way that causes the serial number to not be readily determined.
10. Eccotemp will not pay electricity or fuel costs, or increases in electricity or fuel costs, for any reason whatsoever, including additional or unusual use of supplemental electrical heat.
11. Eccotemp will not be responsible for any default or delay in performance under this Limited Warranty caused by any factor or contingency outside of its control.

#### VII. MISCELLANEOUS

No agent, employee or representative of Eccotemp has any authority to bind Eccotemp to any representation or warranty concerning the Product not contained in this Limited Warranty. Eccotemp reserves the right and authority to change, modify or alter this warranty at any given time.

#### VIII. FOR CUSTOMERS WITH A HOME WARRANTY

Often your home warranty will assist in covering some of the fees related to your home appliances, such as your water heater. Be sure to check with your home warranty company for assistance prior to reaching out to Eccotemp.

PLEASE NOTE: 6GB IS FOR INDOOR PERMANENT INSTALLATIONS ONLY. THIS MANUAL AND ALL ECCOTEMP CONTENT IS SUBJECT TO CHANGE WITHOUT NOTICE.  
PLEASE VISIT [WWW.ECCOTEMP.COM/SUPPORT](http://WWW.ECCOTEMP.COM/SUPPORT) FOR MORE INFORMATION.



# **ECCOTEMP<sup>®</sup>**

HEATING WATER SMARTER

**315-A INDUSTRIAL ROAD, SUMMERVILLE, SC 29483 | 1-866-356-1992**

© Eccotemp 2024 All Rights Reserved | Printing Version 1.0