

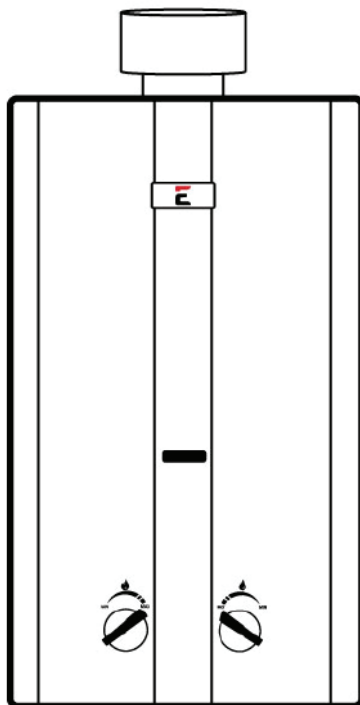

L10 / L10nr

PORTABLE TANKLESS WATER HEATER

INSTALLATION, USE AND CARE INSTRUCTIONS



RECREATIONAL USES



WASH DOWN



EQUESTRIAN



HUNTING



RECREATION



POOL SIDE



FOOD TRUCKS



PET BATHING



GREEN HOUSES



CAMPING



TINY HOMES



EMERGENCY PREP



OFF-GRID

PLEASE RETAIN THIS INSTRUCTION MANUAL FOR FUTURE REFERENCE

! WARNING



CARBON MONOXIDE HAZARD

This appliance can produce carbon monoxide which has no odor.

Using it in an enclosed space can kill you.

Never use this appliance in an enclosed space such as a camper, tent, car or home.

! CAUTION



Vapors from flammable liquids will explode and catch fire causing death or severe burns.

Do not use or store flammable products such as gasoline, solvents or adhesives in the same room or near the water heater.

Keep flammable products :

1. Far away from heater
2. In approved containers
3. Tightly closed
4. Out of children's reach

Water heater has a main burner flame.

The main burner flame:

1. Can come on at any time and
2. Will ignite flammable vapors.

Vapors:

1. Cannot be seen
2. Are heavier than air
3. Go a long way on the floor
4. Can be carried from other rooms to the main burner flame by air currents.

Installation:

Do not install water heater where flammable products will be stored or used unless the main burner flame is at least 18" above the floor. This will reduce, but not eliminate, the risk of vapors being ignited by the main burner flame.

Read and follow water heater warnings and instructions. If owners manual is missing, contact the retailer or manufacturer.

! ATTENTION

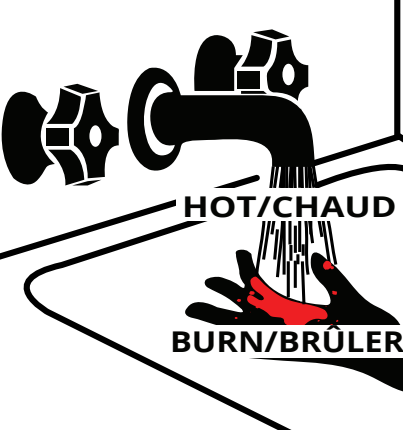

Water temperature over 125°F can cause severe burns instantly or death scalds. Children, disabled, and elderly are at highest risk of being scalded. See instruction manual before setting temperature at water heater. Feel water before using. Temperature limiting valves are available.

! WARNING

Improper installation, use, adjustment, alteration, service, or maintenance can cause injury or property damage. Refer to this manual. For assistance or additional information, consult a qualified installer, service agency, or gas supplier.

! FOR YOUR SAFETY

Fire or Explosion Hazard

Do not store or use gasoline or other flammable vapors and liquids in the vicinity of this or any other appliance.

L10/L10nr PORTABLE TANKLESS WATER HEATER

Use & Care Manual

With Installation Instructions for the Installer

APPLICATION	INSTALLATION	BTU'S	FLOW RATE
Recreational	Outdoor	75,000	3.0 GPM

CONGRATULATIONS!

You've just purchased a new Eccotemp L10/L10nr portable tankless water heater. This will open a world of enjoyment to going tankless!

We highly suggest you take the time to read through all the safety and installation procedures in this manual before attempting to install your new tankless water heater.

Should you have any questions, please feel free to visit our helpdesk located at support.eccotemp.com.

— PLEASE RETAIN THE INSTRUCTION MANUAL FOR FUTURE REFERENCE —

FOR YOUR RECORDS

Write your serial number here: # _____

You can find them on a label on the appliance and/or packaging. Staple sales slip or Proof of Purchase here. Proof of the original purchase date is needed to obtain service under the warranty.

Safety Information	
Safety Precautions	2
Leak Testing	6
Combustion and Ventilation Air	6
Installation Instructions	
Benefits and Recommendations	7
Getting Started	8
Water and Gas Connections	8
Proper Installation	9
Operating Instructions	
Use and Operation	10
Adjustment	11
Functions and Features	12
Maintenance	
Rain Cap Inspection	13
Storage	13
Cleaning Water Screen	13
Flushing Water Heater	14
Troubleshooting	
Troubleshooting	15
Construction and Parts	17
Electrical Wiring	18
Replacement Parts	18
Warranty	
Warranty	19

READ THIS MANUAL

Inside you will find many helpful hints on how to use and maintain your water heater properly. A little preventive care on your part can save you time and money over the life of your water heater. You will find many answers to common problems in the Troubleshooting Guide. If you review the chart of Troubleshooting Tips first, you may not need to call for service.

READ THE SAFETY INFORMATION

Your safety and the safety of others are very important. There are many important safety messages in this manual and on your water heater. Always read and obey all safety messages. This is the safety alert symbol. Recognize this symbol as an indication of Important Safety Information! This symbol alerts you to potential hazards that can kill or hurt you and others.

All safety messages will follow the safety alert symbol and the words: "DANGER", "WARNING", "CAUTION" or "NOTICE". These words mean:

- ! WARNING** - A potentially hazardous situation that could result in death or serious injury and/or damage to property.
- ! DANGER** - An imminently hazardous situation that will result in death or serious injury.
- ! CAUTION** - A potentially hazardous situation that may result in minor or moderate injury.
- ! NOTICE** - Attention is called to observe a specified procedure or maintain a specific condition.

IMPORTANT SAFETY INFORMATION: READ ALL INSTRUCTIONS BEFORE USING

Be sure to read and understand the entire Use and Care Manual before attempting to install or operate this water heater. It may save you time and money. Pay particular attention to the Safety Instructions. Failure to follow these warnings could result in serious bodily injury or death. Should you have problems understanding the instructions in this manual, or have any questions, STOP, and get help from a qualified service technician, or the local gas utility.

PLEASE NOTE: THIS MODEL IS NOT RECOMMENDED, NOR HAS IT BEEN TESTED FOR ANY PERMANENT OR INDOOR INSTALLATION. THIS MODEL IS PART OF OUR PORTABLE, OUTDOOR SERIES AND NEEDS TO BE TAKEN DOWN AND STORED IN A WARM, DRY PLACE AFTER EVERY USE. THIS MANUAL AND ALL ECCOTEMP CONTENT IS SUBJECT TO CHANGE WITHOUT NOTICE. VISIT SUPPORT.ECCOTEMP.COM FOR THE LATEST VERSION OF THE MANUAL AND WARRANTY.

IMPORTANT SAFETY INFORMATION:

READ ALL INSTRUCTIONS BEFORE USING

Be sure to read and understand the entire Use and Care Manual before attempting to install or operate this water heater. It may save you time and money. Pay particular attention to the Safety Instructions. Failure to follow these warnings could result in serious bodily injury or death. Should you have problems understanding the instructions in this manual, or have any questions, STOP, and get help from a qualified service technician, or the local gas utility.

⚠ DANGER!

PROPERLY INSTALL WATER HEATER

Failure to properly install the tankless water heater outdoors as outlined in the installation could result in injury. Failure to follow instructions in this manual can result in unsafe operation of the water heater. To avoid the risk of fire, explosion, or asphyxiation from carbon monoxide, never operate this water heater unless it is installed properly and has an adequate air supply for proper operation. Be sure to inspect the attached rain cap for proper installation at initial start-up; and at least annually thereafter. Refer to the Care and Cleaning section of this manual for more information regarding rain cap inspection.

⚠ WARNING!

Gasoline, as well as other flammable materials and liquids (adhesives, solvents, paint thinners etc.), and the vapors they produce are extremely dangerous. DO NOT handle, use or store gasoline or other flammable or combustible materials anywhere near or in the vicinity of a water heater or any other appliance. Be sure to read and follow the labels on the water heater, as well as the warnings printed in this manual. Failure to do so can result in property damage, bodily injury or death.

⚠ NOTICE!

To ensure that this product is safe to use, Eccotemp has had this model tested and certified by CSA Group and it is marked CSA/ANSI Z21.96:19-CSA 11.6:19 Portable Water Heaters for Outdoor Use.

⚠ WARNING: FIRE OR EXPLOSION HAZARD

If you smell gas:

- Do not attempt to light appliance and make sure appliance is in the OFF position.
- Extinguish any nearby flame(s).
- Shut off cylinder fuel supply valve if so equipped, or if equipment with a disposable fuel cylinder, disconnect the cylinder.
- Leave the area immediately.
- Allow gas to dissipate for 5 minutes.
- If gas smell has dissipated from the area, the appliance, and fuel supply, follow gas connection procedures.
- If you smell gas again, follow steps 1-5 and have appliances serviced. Failure to follow these instructions could result in fire or explosion, which could cause property damage, personal injury or death.

⚠ DANGER! LIQUIFIED PETROLEUM MODELS

Liquid propane has an odorant added to aid in detecting a gas leak. Some people may not physically be able to smell or recognize this odorant. If you are unsure or unfamiliar with the smell of liquid propane, ask the gas supplier.

Other conditions, such as "odorant fade", which causes the odorant to diminish in intensity, can also hide or camouflage a gas leak. Always check with commercial leak detector or soapy water.

- Gas detectors are recommended in liquid propane applications and their installation should be in accordance with the detector manufacturer's recommendations and/or local laws, rules and regulations.
- Water heaters utilizing liquid propane gas are different from natural gas models. A natural gas water heater will not function safely on liquid propane gas and vice versa.
- No attempt should ever be made to convert the tankless water heater from liquid propane to natural gas. To avoid possible equipment damage, personal injury or fire, do not connect the water heater to a fuel type not in accordance with the portable tankless water heater data plate: propane for propane portable tankless water heaters and natural gas for natural gas portable tankless water heaters. These portable tankless water heaters are not certified for any other fuel type.
- Liquid propane gas must be used with great caution. It is heavier than air and will collect first in lower areas making it hard to detect at nose level.
- Before attempting to light the water heater, make sure to look and smell for gas leaks. Use a soapy solution to check all gas fittings and connections. Bubbling at a connection indicates a leak that must be corrected. When smelling to detect a gas leak, be sure to sniff near the floor also.
- It is recommended that more than one method, such as soapy solution, gas detectors, etc., be used to detect leaks in gas applications.

⚠ NOTICE

IF A GAS LEAK IS PRESENT OR SUSPECTED:

- **DO NOT attempt to find the cause for yourself.**
- **DO NOT attempt to try to light the water heater.**
- **DO NOT touch any electrical switch.**

⚠ ADDITIONAL WARNINGS!

1. Do not leave unattended.
2. The exhaust gas and top of the portable tankless water heater is HOT! Do not place hands or any foreign object near the top of the heater.
3. Do not use in high wind conditions.
4. If the smell of gas is detected, turn off the gas valve at the tank immediately! Do not use flame for leak detection.
5. Use only liquid propane.
6. Use only outdoors.
7. Do not over tighten the gas regulator connection to the portable tankless water heater with a wrench. This may cause a crack in the gas regulator.

PLEASE NOTE: THIS MODEL IS NOT RECOMMENDED, NOR HAS IT BEEN TESTED FOR ANY PERMANENT OR INDOOR INSTALLATION. THIS MODEL IS PART OF OUR PORTABLE, OUTDOOR SERIES AND NEEDS TO BE TAKEN DOWN AND STORED IN A WARM, DRY PLACE AFTER EVERY USE. THIS MANUAL AND ALL ECCOTEMP CONTENT IS SUBJECT TO CHANGE WITHOUT NOTICE. VISIT SUPPORT.ECCOTEMP.COM FOR THE LATEST VERSION OF THE MANUAL AND WARRANTY.

PLEASE NOTE: THIS MODEL IS NOT RECOMMENDED, NOR HAS IT BEEN TESTED FOR ANY PERMANENT OR INDOOR INSTALLATION. THIS MODEL IS PART OF OUR PORTABLE, OUTDOOR SERIES AND NEEDS TO BE TAKEN DOWN AND STORED IN A WARM, DRY PLACE AFTER EVERY USE. THIS MANUAL AND ALL ECCOTEMP CONTENT IS SUBJECT TO CHANGE WITHOUT NOTICE. VISIT SUPPORT.ECCOTEMP.COM FOR THE LATEST VERSION OF THE MANUAL AND WARRANTY.

Leak Testing

⚠ WARNING: Never use an open flame to test for gas leaks, as property damage, personal injury, or death could result.

- The tankless water heater and its gas connections must be leak tested at normal operating pressures before it is placed in operation.
- Turn on the gas to the tankless water heater from the recommended gas cylinder.
- Use a commercial leak detector or soapy water solution to test for leaks at all connections and fittings.
- Bubbles indicate a gas leak that must be corrected.

The factory connections should be leak tested after the tankless water heater is placed in operation. Not doing so could cause water damage which may or may not be repairable. Please check the warranty information found on our website at www.eccotemp.com for more information on freezing issues.

Pressure Relief Valve

A new pressure relief valve, complying with the standard for pressure relief valves and automatic gas shut-off Devices for Hot Water Supply Systems, ANSI Z21.22, must be installed at the hot water outlet connection of the tankless water heater at the time of installation. Local codes shall govern the installation of pressure relief valves.

The diagram to the right illustrates a pressure only relief valve. If local codes require a combination and pressure relief valve be installed, an extension piece may be required.

For safe operation of the water heater, be sure that:

- The pressure rating of the pressure relief valve must not exceed 150 psi, the maximum working pressure of the tankless water heater as marked on the rating plate.
- The BTUH rating of the pressure relief valve must equal or exceed the BTUH input of the tankless water heater as marked on its rating plate.
- No valve of any type should be installed between the pressure relief valve and the water heater.
- The discharge line must be NO SMALLER than the outlet of the valve and must pitch downward to allow complete drainage (by gravity) of the pressure relief valve and discharge line.
- The end of the discharge line should not be threaded or concealed. No valve of any type, restriction or reducer coupling should be installed in discharge line.

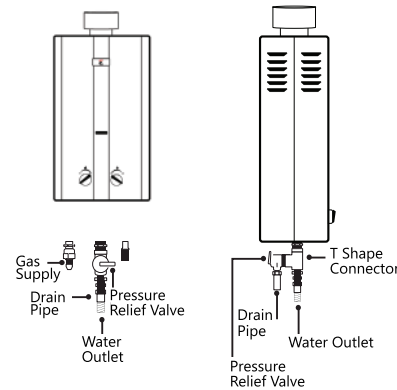

Combustion and Ventilation Air

⚠ Warning!

Gasoline, as well as other flammable materials and liquids (adhesives, solvents, paint thinners etc.), and the vapors they produce are extremely dangerous. DO NOT handle, use or store gasoline or other flammable or combustible materials anywhere near or in the vicinity of a water heater or any other appliance. Be sure to read and follow the labels on the water heater, as well as the warnings printed in this manual. Failure to do so can result in property damage, bodily injury or death.

This water heater is for OUTDOOR installation ONLY. It must NOT be installed indoors or in a confined space.

An air supply containing halogenated hydrocarbons may be safe to breathe, but when it passes through a gas flame corrosive elements are released that will shorten the life of any gas burning appliance.

Propellants from common spray cans or gas leaks from A/C and refrigeration equipment are highly corrosive after passing through a flame and therefore should never be used around the water heater.

The tankless water heater warranty is voided when failure of the heater is due to operation in a corrosive atmosphere.

PLEASE NOTE: THIS MODEL IS NOT RECOMMENDED, NOR HAS IT BEEN TESTED FOR ANY PERMANENT OR INDOOR INSTALLATION. THIS MODEL IS PART OF OUR PORTABLE, OUTDOOR SERIES AND NEEDS TO BE TAKEN DOWN AND STORED IN A WARM, DRY PLACE AFTER EVERY USE. THIS MANUAL AND ALL ECCOTEMP CONTENT IS SUBJECT TO CHANGE WITHOUT NOTICE. VISIT SUPPORT.ECCOTEMP.COM FOR THE LATEST VERSION OF THE MANUAL AND WARRANTY.

The L10/L10nr Portable Tankless Water Heater

BENEFITS AND RECOMMENDED USES

The Eccotemp L10/L10nr is a portable liquid propane fired tankless water heater capable of delivering 1.5 to 3 gallons of hot water per minute to almost anywhere. The portable tankless water heater has standard 1/2" NPT pipe fittings and an adapter for using a standard garden hose for inlet water supply. People around the world use similar portable tankless water heaters to heat water for recreational use, safely and reliably.

If you purchased model L10nr, your product does not include a stainless steel rain cap. The rain cap is sold separately.

Included with your L10/L10nr Portable Tankless Water Heater is a CSA approved regulator with hose. If you purchased the L10/L10nr Bundle then you received in addition to the above items the EccoFlo 12v water pump and strainer.

The automatic ignition is powered by 2 "D" Cell Batteries (not included). When water starts flowing through the tankless water heater the burner ignites and starts producing instant hot water! No pilot light! Ideal water pressure for operation is 20-80 psi.

Required gas supply should be from a standard 20 pound, 4.7 gallon, liquid propane (LP) cylinder (not included). A standard North American 20 gallon propane tank is 18 inches tall and 12 inches in diameter. LP-gas cylinders must either be designed, fabricated, tested and marked (or stamped) in accordance with the regulations of the U.S. Department of Transportation (DOT) or for use in Canada, cylinders must be constructed and marked in accordance with the specifications for Cylinders, Spheres, and Tubes for the Transportation of Dangerous Goods, CSA B339.

- Do not store a spare LP gas cylinder under or near this appliance.
- Never fill the cylinder beyond 80 percent full.

⚠ If the information above is not followed exactly, a fire causing death or serious injury may occur.

Outdoor Recreational Uses



PLEASE NOTE: THIS MODEL IS NOT RECOMMENDED, NOR HAS IT BEEN TESTED FOR ANY PERMANENT OR INDOOR INSTALLATION. THIS MODEL IS PART OF OUR PORTABLE, OUTDOOR SERIES AND NEEDS TO BE TAKEN DOWN AND STORED IN A WARM, DRY PLACE AFTER EVERY USE. THIS MANUAL AND ALL ECCOTEMP CONTENT IS SUBJECT TO CHANGE WITHOUT NOTICE. VISIT SUPPORT.ECCOTEMP.COM FOR THE LATEST VERSION OF THE MANUAL AND WARRANTY.



Get Started

1. Check box for damage. Damages caused in shipment must be reported immediately.
2. Make sure you have all the parts:

Please note: included parts and accessories may vary depending on country and regulations.

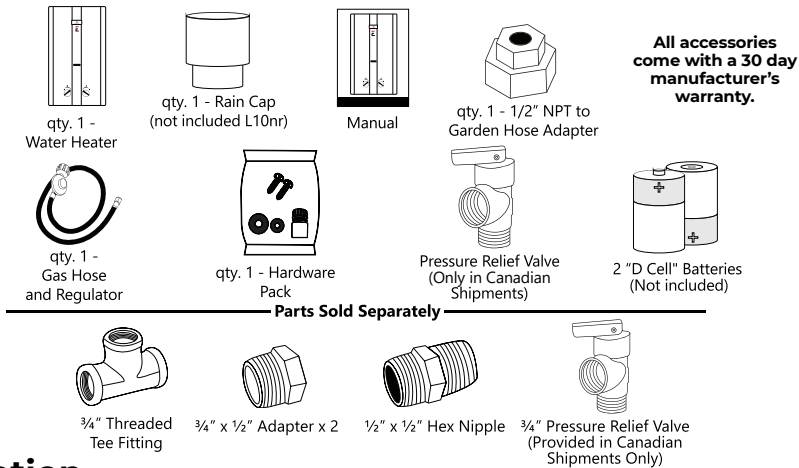

Location

THIS WATER HEATER IS FOR OUTDOOR USE ONLY!

- This model is an outdoor model and must be mounted on a vertical wall. It must not be installed indoors or in a confined space. Make sure people (particularly children, disabled, and elderly) will not touch the hot water outlet or the exhaust vent. The exhaust vent and air inlet must be clear and not have anything obstructing the flow of combustion and ventilation air.
- The tankless water heater must be installed in a fire retardant area, and must be away from all flammable materials. Clearance should be 4 ft to the left and right side of flammable materials and 6.75 ft to the front.
- The tankless water heater should be installed in open area where strong wind currents are not prevalent. Take measures to avoid direct wind, rain and snow.
- Make sure the tankless water heater is not temporarily installed in a location where damage can occur, for example, by moving vehicles or area flooding, etc.

Water and Gas Connections

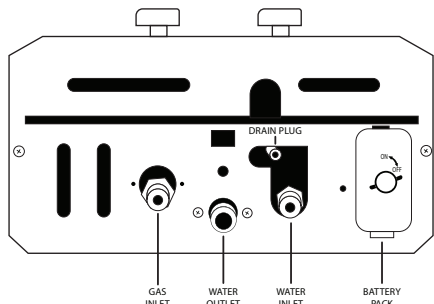

NOTICE: Sealant tape included in your hardware pack should be used on your water inlet and outlet pipes before connecting your water source or output device.

PLEASE NOTE: THIS MODEL IS NOT RECOMMENDED, NOR HAS IT BEEN TESTED FOR ANY PERMANENT OR INDOOR INSTALLATION. THIS MODEL IS PART OF OUR PORTABLE, OUTDOOR SERIES AND NEEDS TO BE TAKEN DOWN AND STORED IN A WARM, DRY PLACE AFTER EVERY USE. THIS MANUAL AND ALL ECCOTEMP CONTENT IS SUBJECT TO CHANGE WITHOUT NOTICE. VISIT SUPPORT.ECCOTEMP.COM FOR THE LATEST VERSION OF THE MANUAL AND WARRANTY.

Proper Installation

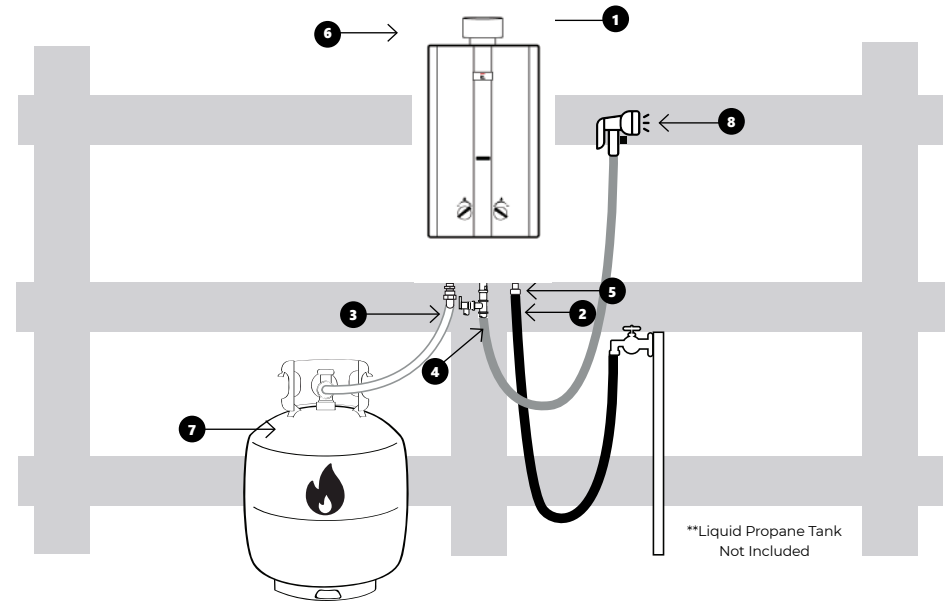

WARNING: If using with non-potable water, do not heat water for human consumption.

1. Attach the rain cap securely to the top of your portable tankless water heater by sliding the circular fitting over the circular exhaust pipe located on the top of the water heater. It should fit securely with no additional fasteners needed. (Not included with the L10nr)
2. If using a standard garden hose, attach the 1/2" NPT to garden hose adapter to the fitting marked "Water Input". Use sealant tape or other approved sealing method on the threads for a secure, watertight fit. Check to make sure the screen inside the water inlet is in place and clean. Then attach your water input/garden hose.
3. Install gas supply line and regulator to the portable tankless water heater by using 2 wrenches, one on the compression fitting already attached to the tankless water heater and the other on the gas line. **DO NOT OVER TIGHTEN. OVER TIGHTENING MAY CRACK THE GAS REGULATOR CAUSING A GAS LEAK!** Check for any gas leaks before ignition! Make sure the gas connection is secured and cylinder is in an upright position for proper vapor withdrawal.
4. Attach a hose to the water output to the fitting marked "Water Outlet". Do not over tighten. If using with a pressure relief valve the pressure relief valve should be installed to the tankless water heater first and then a hose.
5. Install two "D Cell" batteries into the battery compartment on the bottom of the heater. Check that the batteries are facing the correct direction. Additional parts are necessary when installing with pressure relief valve. See pg. 8 for more details.
6. Use the top tab on the portable tankless water heater to suspend from a mounted screw capable of holding 30 pounds. Place at a comfortable height without putting stress on the gas hose. Do not use suspended from the handle! Do not permanently mount this portable tankless water heater!
7. Attach gas regulator with hose to the LP tank. Use hand pressure only on the plastic connector. LEAVE GAS TANK VALVE IN THE "OFF" POSITION.
8. Garden hose spray head not included. Great for washing animals, dirty hands and equipment.

PLEASE NOTE: THIS MODEL IS NOT RECOMMENDED, NOR HAS IT BEEN TESTED FOR ANY PERMANENT OR INDOOR INSTALLATION. THIS MODEL IS PART OF OUR PORTABLE, OUTDOOR SERIES AND NEEDS TO BE TAKEN DOWN AND STORED IN A WARM, DRY PLACE AFTER EVERY USE. THIS MANUAL AND ALL ECCOTEMP CONTENT IS SUBJECT TO CHANGE WITHOUT NOTICE. VISIT SUPPORT.ECCOTEMP.COM FOR THE LATEST VERSION OF THE MANUAL AND WARRANTY.



⚠ BEFORE GOING TO THE USE SECTION:

Check around area for flammables, especially gasoline or other vapors which may ignite. The exhaust and top of the portable tankless water heater will get HOT! Make sure there are no foreign objects around the portable tankless water heater or that have fallen into the top.

Use and Operation

This water heater is for point of use and is meant for temporary water heating. You should not connect to a permanent inlet water connection or connect to a water distribution system to supply multiple outlets. If this water heater is only intended for use with non-potable water, do not consume the water internally. This water heater does not screen contaminants and poses a potential health risk if used to heat water for consumption.

⚠ WARNING: This model is intended for recreational & portable use only. This model CANNOT be permanently mounted or plumbed in any way.

1. Be sure the hose or other water outlet device is in the "OFF" position.
2. Set the water regulator knob on the face of the portable tankless water heater to its highest setting.
3. Set the gas regulator knob on the face of the portable tankless water heater to its minimum setting.
4. Make sure the gas cylinder is in an upright position and turn the gas valve on the cylinder all the way open.
5. IF THE SMELL OF GAS IS DETECTED, TURN OFF THE GAS VALVE FROM THE LP-GAS SUPPLY CYLINDER IMMEDIATELY!!!
6. Turn on incoming water supply. Ensure that you have adequate water pressure between 20-80 PSI.
7. Turn on your hose or other water output device to the "ON" position and adjust to the desired water flow.
8. There will be a series of audible clicks and the burner will ignite. Should the burner not ignite after 5 seconds, shut off and go to the "Trouble Shooting" section.
9. Upon completion, turn the hose off or other water output off.
10. Turn your gas and water supply off.
11. For storage, disconnect the water and gas lines from your portable tankless water heater.
12. Drain the water heater by unscrewing the drain plug from the bottom of the tankless water heater. See page 8 for location.
13. Store water heater when not in use in a safe, warm and dry place.
14. This gas powered water heater can not work under 32 °F (0 °C).

⚠ WARNING: If the outside temperature is around or below freezing (32°F, 0° C), ensure that the drain plug is opened and water drained from the portable tankless water heater after each use to avoid internal damage to the water heater. You will also need to unhook the outgoing water line to ensure that any water in the heat exchanger is drained. Failure to properly drain your portable tankless water heater will cause water damage which may or may not be repairable. Please check the warranty information found on our website at www.eccotemp.com for more information on freezing issues.

This appliance must be installed in accordance with local codes or, in the absence of local codes, the National Fuel Gas Code, ANSI Z223.1/NFPA 54, or the Natural Gas and Propane Installation Code, CSA B149.1, or the Propane Storage and Handling Code, CSA B149.2

⚠ WARNING!

GAS HOSE ADAPTER

THE L10/L10nr PORTABLE TANKLESS WATER HEATER HAS A 1/2" TO 3/8" ADAPTER ALREADY ATTACHED TO THE GAS INLET ON THE WATER HEATER.

PLEASE ENSURE THE ADAPTER IS CORRECTLY INSTALLED WITH THREAD SEALANT. A SPOOL OF SEALANT TAPE IS INCLUDED WITH THE WATER HEATER.

MULTIPLE WRAPS OF SEALANT TAPE MAY BE NECESSARY TO ASSURE COMPLETE SEAL.

ALWAYS CHECK FOR GAS LEAKS BEFORE USING HEATER.

PLEASE NOTE: THIS MODEL IS NOT RECOMMENDED, NOR HAS IT BEEN TESTED FOR ANY PERMANENT OR INDOOR INSTALLATION. THIS MODEL IS PART OF OUR PORTABLE, OUTDOOR SERIES AND NEEDS TO BE TAKEN DOWN AND STORED IN A WARM, DRY PLACE AFTER EVERY USE. THIS MANUAL AND ALL ECCOTEMP CONTENT IS SUBJECT TO CHANGE WITHOUT NOTICE. VISIT SUPPORT.ECCOTEMP.COM FOR THE LATEST VERSION OF THE MANUAL AND WARRANTY.

Adjustment

The temperature of the outgoing water is dependent on the temperature of the incoming water balanced with the amount of heat applied. Use extreme caution when setting the outlet water temperature.

1. Turn the water knob to max.
2. Turn gas knob to min.
3. Turn on gas.
4. Turn on water.
5. Turn the hose on. (Or other outlet device)
6. Wait to hear a series of audible clicks.
7. Upon completion, turn off the hose.
8. Turn off water supply.
9. Turn off gas supply.
10. Disconnect water and gas lines.
11. Drain plug open. See page 9 for location of pressure drain plug.
12. Store in a safe, warm, dry place.

⚠ WARNING: Do not alter or change this water heater's original temperature sensor.

⚠ WARNING: Should overheating occur or the gas supply fail to shut off, turn off the manual gas control valve to the appliance.

⚠ WARNING: THE PORTABLE TANKLESS WATER HEATER IS CAPABLE OF PRODUCING SCALDING WATER TEMPERATURES!

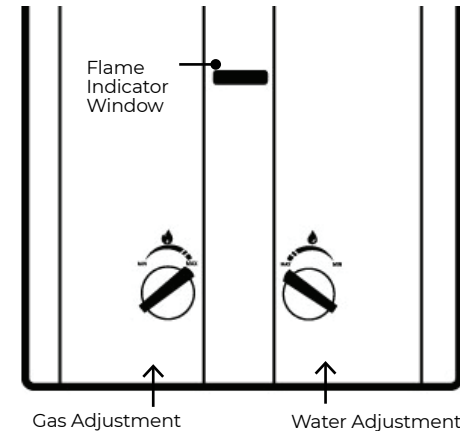

PLEASE NOTE: THIS MODEL IS NOT RECOMMENDED, NOR HAS IT BEEN TESTED FOR ANY PERMANENT OR INDOOR INSTALLATION. THIS MODEL IS PART OF OUR PORTABLE, OUTDOOR SERIES AND NEEDS TO BE TAKEN DOWN AND STORED IN A WARM, DRY PLACE AFTER EVERY USE. THIS MANUAL AND ALL ECCOTEMP CONTENT IS SUBJECT TO CHANGE WITHOUT NOTICE. VISIT SUPPORT.ECCOTEMP.COM FOR THE LATEST VERSION OF THE MANUAL AND WARRANTY.

Functions and Features

- **Water controlled automatic ignition:** Water pressure between 20-80 PSI and 1.5 - 3.0 GPM opens the ignition circuit for easy and convenient operation.
- **Auto cut-off protection:** The auto cut-off protection will shut the gas supply off immediately in the event of flameout to reduce the risk of gas leakage.
- **Remove drain valve to avoid water pipe and regulator damage caused by freezing water.***
- **Anti-dry combustion protection:** The portable tankless water heater will shut off the gas supply in the event water stops flowing through the portable tankless water heater.

Read the maintenance section on draining the portable tankless water heater entirely to avoid freeze related issues.

TEMPERATURE INCREASE PER GPM					
MODEL	Gas Setting	1.5 GPM	2.0 GPM	2.5 GPM	3.0 GPM
10/L10nr	Highest	96°	48°	32°	25°
	Lowest	34°	17°	11°	9°

⚠ NOTICE - Temperature increases listed are based on use of the tankless water heater under optimal conditions. Variable factors such as incorrect or imperfect installation and varying incoming water temperatures may yield different results.

TECHNICAL SPECIFICATIONS - PORTABLE	
Gas Type	Liquid Propane Gas (LPG)
Model	L10/L10nr
Water Pressure	20-80 PSI
Gas Input Rating	24,000-75,000 Btu/hr
Manifold Gas Pressure	11 in w.c. (2.74 kPa)
Ignition	Electric Pulse, (2) D Cell Battery Powered (No electrical connection required)
Protections	Auto cut-off water control, automatic ignition, anti-dry combustion protection, over-pressure overheating and flameout protection
Dimensions	32.25" x 14" x 7.75"
Weight	22.4 lbs.
Pipe fittings	1/2" NPT, incoming/outgoing water & gas
Certification	CSA/ANSI Z21.96 - CSA 11.6 (2019) Portable Water Heaters for outdoor use.

Rain Cap Inspection

Be sure to turn the unit off and disconnect the water supply before performing any housekeeping tasks to this tankless water heater. Vacuum around the tankless water heater for dust, dirt and lint on a regular basis. Clean the tankless water heater and front panel by using a damp soft cloth with a few drops of mild detergent and gently wiping the surfaces of the unit. Wipe any remaining moisture with a dry soft cloth.

Storage

When not in use, your portable tankless water heater should be stored away in a climate-controlled area.

⚠ WARNING: Item should not be left or stored in freezing conditions (at or below 32°F / 0°C). Internal damage can occur.

Upon completion of use, prepare your water heater for storage:

1. Turn OFF water and gas supply and then disconnect from water heater.
2. Unscrew the drain valve (ribbed cylindrical stem next to the water input valve) to ensure draining of water.
3. Remove the screen at the end of the water inlet pipe and clean. Return screen after cleaning. (see housekeeping section above for instructions)
4. Store tankless water heater in a climate-controlled area.

When the tankless water heater is not in use and remains connected to the LP-gas supply cylinder, the tankless water heater and cylinder must be stored outdoors, in a well ventilated space, out of the reach of children, and must not be operated in a building, garage or any other enclosed area.

Storage of the tankless water heater indoors is permissible only if the cylinder is disconnected and removed from the water heater.

LP-gas cylinders must be stored outdoors, in a well-ventilated space, out of the reach of children, and must not be stored in a building, garage or any other enclosed area.

Cleaning the Water Screen

1. Make sure the water heater is OFF.
2. Disconnect the water supply from the water heater.
3. Locate the screen at the end of the water inlet pipe and gently remove with a screwdriver.
4. Rinse the screen in a sink or with a hose to remove any debris.
5. Return the screen by gently inserting back into the end of the water inlet pipe.
6. Reconnect the water supply and turn ON the water heater.
7. Clean the water screen on a monthly basis.

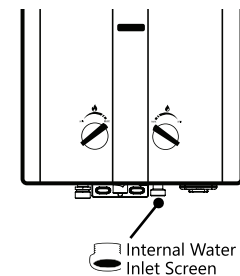

PLEASE NOTE: THIS MODEL IS NOT RECOMMENDED, NOR HAS IT BEEN TESTED FOR ANY PERMANENT OR INDOOR INSTALLATION. THIS MODEL IS PART OF OUR PORTABLE, OUTDOOR SERIES AND NEEDS TO BE TAKEN DOWN AND STORED IN A WARM, DRY PLACE AFTER EVERY USE. THIS MANUAL AND ALL ECCOTEMP CONTENT IS SUBJECT TO CHANGE WITHOUT NOTICE. VISIT SUPPORT.ECCOTEMP.COM FOR THE LATEST VERSION OF THE MANUAL AND WARRANTY.

Flushing your Water Heater

It is highly recommended that you clean your Eccotemp portable tankless water heater every 6 months to ensure your water heater is running as efficiently as possible. Exposure to unfiltered water can increase your chances of water scale, lime or rust deposit buildup.

To do this we recommend that you use our Eccotemp **EZ-Flush Descaler System** to flush out any unwanted build-up and sediment. For more information and to purchase please **visit us at www.eccotemp.com or call 1-866-356-1992.**

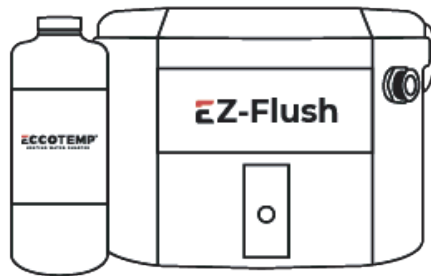

Use code: **EZFLUSH22**
for 10% off EZ Flush

⚠ DANGER: Before disconnecting the water supply, make certain no one will be exposed to the danger of the hot water released by disconnecting. The water may be hot enough to create a scald hazard. The water should be released into a suitable drain to prevent injury or property damage.

⚠ DANGER: Hotter water increases the potential for hot water scalds.

⚠ DANGER: Failure to perform the recommended routine preventative maintenance can harm the proper operation of this water heater, which can cause carbon monoxide dangers, excessive hot water temperatures and other potentially hazardous conditions.

When properly maintained, your water heater will provide years of dependable trouble-free service. It is recommended that a periodic inspection of the burner, water screen and top exhaust should be made by service personnel qualified in gas appliance repair.

It is suggested that a routine preventive maintenance program be established and followed by the user.

Inspect the area around the tankless water heater to ensure a safe operating environment. Keep water heater area clear and free from combustible materials, gasoline, and other flammable vapors and liquids. Ensure the tankless water heater has not been damaged. If damage or denting is present, contact a service personnel to verify proper operation.

Check for any abnormal sounds during normal operation of the water heater.

All piping should be checked for gas and/or water leaks. Refer to page 4 of this manual for instructions on leak testing.

The air intake and cold water supply screen should be cleaned monthly. Refer to the "Housekeeping" section for further information.

DO NOT operate the tankless water heater if you feel something is wrong with the unit.

DO NOT allow children to operate or otherwise handle the unit.

PLEASE NOTE: THIS MODEL IS NOT RECOMMENDED, NOR HAS IT BEEN TESTED FOR ANY PERMANENT OR INDOOR INSTALLATION. THIS MODEL IS PART OF OUR PORTABLE, OUTDOOR SERIES AND NEEDS TO BE TAKEN DOWN AND STORED IN A WARM, DRY PLACE AFTER EVERY USE. THIS MANUAL AND ALL ECCOTEMP CONTENT IS SUBJECT TO CHANGE WITHOUT NOTICE. VISIT SUPPORT.ECCOTEMP.COM FOR THE LATEST VERSION OF THE MANUAL AND WARRANTY.

Troubleshooting

Portable tankless water heater will not start – there are no audible clicks at startup:

1. The first thing to check is to ensure that the incoming water is connected to the "right" connection side of the portable tankless water heater. If the incoming and outgoing connections are reversed, the portable tankless water heater will not work. The incoming is on the far right and the outgoing water connection is in the middle.
2. Check to make sure you have fresh batteries and they are installed in the correct position.
3. Make sure that you have a minimum of 20 PSI of sustained water pressure. Number one reason that the portable tankless water heater does not ignite is that there is not enough water pressure.
4. Check to ensure that no wires have disconnected inside the portable tankless water heater during shipping. Make sure the gas is in the OFF position. The front cover is held on 6 screws: 4 on top and 2 on the bottom. All the wiring is done with push together plastic connectors. They are all visible without further dismantling of the portable tankless water heater. It should be obvious when a wire has become disconnected.

NOTE: Call technical support at 866.356.1992 if unsure how to remove the front cover.

5. It is possible that some debris or epoxy might have entered the water regulator. Check to see if the filter screen on the water inlet is clear of debris. You can also reverse the hookup by taking your water source and hooking it up to the water outlet side and back flushing the system to ensure there is no blockage.
6. If you've checked everything and the water heater still continues to not ignite, you can try a water pressure adjustment. **Please email support@eccotemp.com for instructions.**
7. There is a simple test that we can help you perform if you are unaware if you have enough water pressure. **Please visit the [Eccotemp helpdesk at support.eccotemp.com](http://EccotempHelpdesk@support.eccotemp.com) or contact us via email at support@eccotemp.com for additional troubleshooting steps.**
8. Propane gas cylinders sometimes are contaminated with air, especially new tanks upon their first filling. Cycle the portable tankless water heater on and off by using the hose switch several times (5) to purge the air from the gas.
9. Should a portable tankless water heater fail to light or stay lit after 10 cycles, please visit support.eccotemp.com or contact us via email at support@eccotemp.com for additional troubleshooting steps.

DO NOT RETURN TO STORE

Visit our Helpdesk at support.eccotemp.com or contact us via email at support@eccotemp.com if you run into a problem.

PLEASE NOTE: THIS MODEL IS NOT RECOMMENDED, NOR HAS IT BEEN TESTED FOR ANY PERMANENT OR INDOOR INSTALLATION. THIS MODEL IS PART OF OUR PORTABLE, OUTDOOR SERIES AND NEEDS TO BE TAKEN DOWN AND STORED IN A WARM, DRY PLACE AFTER EVERY USE. THIS MANUAL AND ALL ECCOTEMP CONTENT IS SUBJECT TO CHANGE WITHOUT NOTICE. VISIT SUPPORT.ECCOTEMP.COM FOR THE LATEST VERSION OF THE MANUAL AND WARRANTY.

Troubleshooting Continued...

The water does not get hot enough:

1. Ensure you are not operating the portable tankless water heater above 2,000 feet. While it has been field tested up to 2,000 feet, we only recommend using it below 2,000 feet. For every 1,000 feet above the recommended 2,000 feet, you will see a 10% decrease in efficiency and performance.
2. Be sure you have your gas knob turned to max and your water knob turned a little lower towards min. The less water moving through the water heater will allow for a higher temperature. Please note: Your incoming water temperature will play a major role in the achievable temperatures your water heater can reach. The colder the incoming water is, the lower the achievable temperature will be. You'll need to adjust your hot and cold knobs to help counteract the colder incoming water. Variable factors such as incorrect or imperfect installations and varying incoming water temperatures may yield different results.
3. Look into the viewer pane (1 small window on the front cover) to see if there is a blue flame. If the flame is yellow there could be a cracked gas regulator. DO NOT ATTEMPT to use the portable tankless water heater if a cracked gas regulator is suspected. Visit support.eccotemp.com or call 1-866-356-1992 for assistance with this matter.

Water is flowing, but there is no hot water coming out:

1. Ensure that you have the incoming water supply and the outgoing water supply hooked up properly. Your water supply should be attached to your incoming connection (located on the far right) and a hose should be attached to the outgoing water connection (located as the center connection).
2. Ensure that you have adequate water pressure of at least 20 PSI sustained.
3. Ensure that you have adequate gas in your propane bottle and that the LP regulator is threaded all of the way onto the portable tankless water heater.
4. Fresh batteries are required for ignition spark. Make sure batteries are aligned in the proper polarity (+/-): flat negative of battery toward the spring side of battery compartment.

The portable tankless water heater will not stay on:

1. The portable tankless water heater requires a minimum of about .75 GPM and a minimum of about 20 PSI to activate and approximately 20 sustained PSI to continue to operate. Consider your water source: Are you using a pump to draw water from a source? Be sure the pump you are using provides adequate sustained water pressure to activate and keep the water heater running.
2. Check that your batteries are fresh and aligned with the proper polarity (+/-): flat negative of battery toward the spring side of the battery compartment.

Construction and Parts of the L10/L10nr

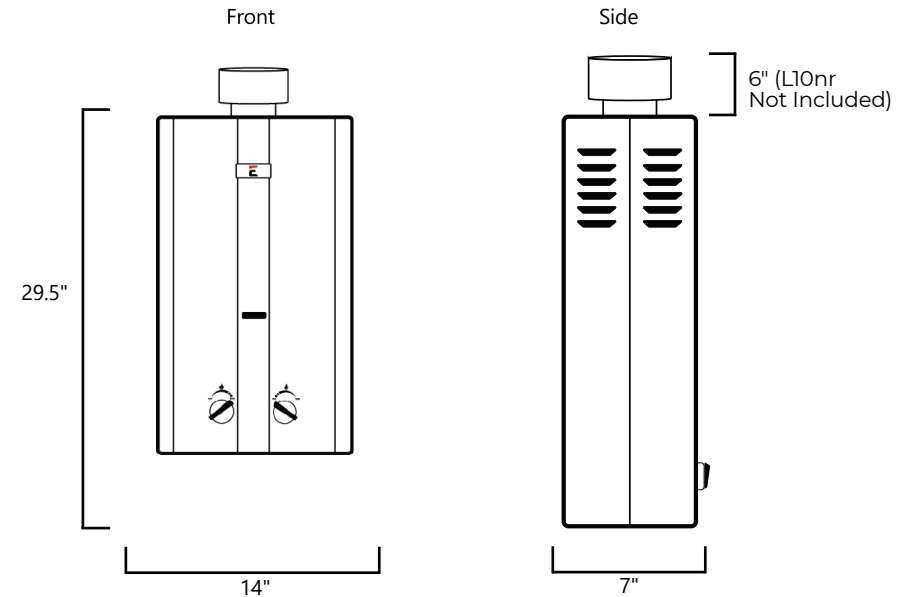
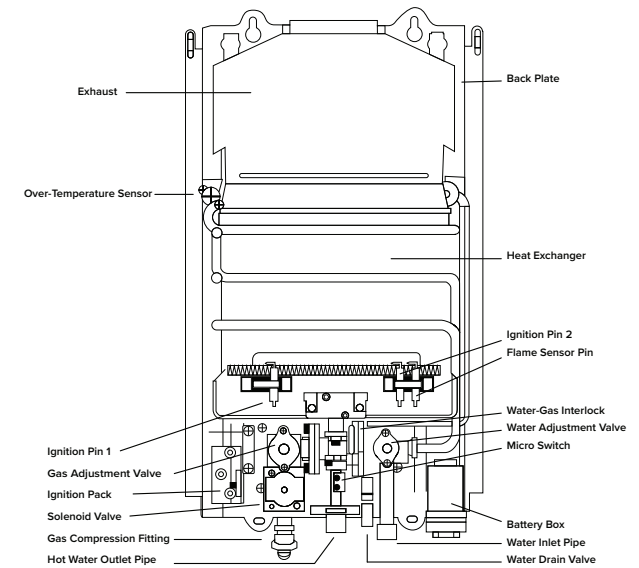

Weight: 22.8 lbs. | 22 lbs. without raincap

PLEASE NOTE: THIS MODEL IS NOT RECOMMENDED, NOR HAS IT BEEN TESTED FOR ANY PERMANENT OR INDOOR INSTALLATION. THIS MODEL IS PART OF OUR PORTABLE, OUTDOOR SERIES AND NEEDS TO BE TAKEN DOWN AND STORED IN A WARM, DRY PLACE AFTER EVERY USE. THIS MANUAL AND ALL ECCOTEMP CONTENT IS SUBJECT TO CHANGE WITHOUT NOTICE. VISIT SUPPORT.ECCOTEMP.COM FOR THE LATEST VERSION OF THE MANUAL AND WARRANTY.

Electrical Wiring

This connection is for low-voltage batteries or direct current only. Do not connect 120 or 240 volts AC.

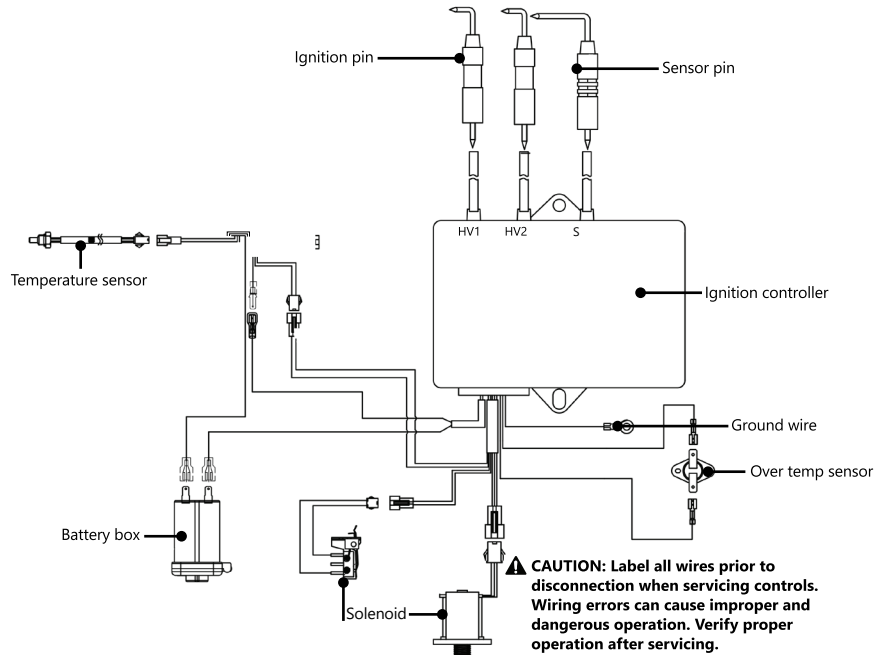

▲ NOTICE - If any of the original wire as supplied with the appliance shall be replaced, it shall be replaced with the original type wire or its temperature equivalent.

Replacement parts

For more available parts for your Eccotemp Water Heater and to purchase, visit www.eccotemp.com/parts or call 1-866-356-1992.

REPLACEMENT PART	SKU	REPLACEMENT PART	SKU
Battery Box	1001026	Hardware Pack	CSAL10HWP
1/2" NPT to Garden Hose Adapter	502028	Pressure Relief Valve	22454877
Gas Regulator and Hose	502005		

PLEASE NOTE: THIS MODEL IS NOT RECOMMENDED, NOR HAS IT BEEN TESTED FOR ANY PERMANENT OR INDOOR INSTALLATION. THIS MODEL IS PART OF OUR PORTABLE, OUTDOOR SERIES AND NEEDS TO BE TAKEN DOWN AND STORED IN A WARM, DRY PLACE AFTER EVERY USE. THIS MANUAL AND ALL ECCOTEMP CONTENT IS SUBJECT TO CHANGE WITHOUT NOTICE. VISIT SUPPORT.ECCOTEMP.COM FOR THE LATEST VERSION OF THE MANUAL AND WARRANTY.

Eccotemp Systems, LLC Limited Warranty

I. LIMITED WARRANTY

Subject to the terms below, Eccotemp Systems, LLC ("Eccotemp") provides this limited warranty (the "Limited Warranty") to cover the following Products and Covered Components:

PRODUCT NAME	COVERED COMPONENTS
L10 Portable Tankless Water Heater	L10 Portable Tankless Water Heater and accessories: CSA certified gas regulator and hose, mounting hardware, and garden hose quick connect.

This Limited Warranty is being provided to the original purchaser and subsequent owners (the "Owner"), but only while the Product remains as the site of the original installation.

II. LIMITED WARRANTY PERIOD

The term of this Limited Warranty (the "Warranty Period") begins on the date of purchase and ends as set forth below:

1 YEAR WARRANTY	The covered components, except for the Heat Exchanger, in the Product are warranted by Eccotemp for a period of one (1) year from the date of purchase when installed according to Eccotemp's Installation and Operating Instructions
	The Heat Exchanger in the Product is warranted by Eccotemp for a period of one (1) year from the date of purchase when installed according to Eccotemp's Installation and Operating Instructions.
30 DAY WARRANTY	All accessories that have been provided with the Product at no cost are warranted by Eccotemp for a period of thirty (30) days from the date of purchase when installed according to Eccotemp's Installation and Operating Instructions.

III. WARRANTY COVERAGE

If, during the Warranty Period, a component in the Product fails because of a manufacturing defect, Eccotemp will repair, replace, or refund the Product to the Owner at Eccotemp's sole discretion and as determined to be appropriate by the Eccotemp Support Team. As set forth in Section IV, the Owner may be responsible for all shipping, freight, and handling charges, as well as all fees and costs associated with the warranty service, including, but not limited to, all labor and other costs involved in diagnostic calls or in removing, repairing, servicing, or replacing any component. Eccotemp's sole responsibility under this Limited Warranty is to repair, replace, or refund the cost of the Product at Eccotemp's sole discretion. In the event that an exact replacement component is no longer available, Eccotemp will, at its option, provide a substitute component that Eccotemp deems suitable for the Product. If the Owner reports a subsequent issue with any covered component in the Product, the Owner may be responsible for retaining the failed component(s) for 90 days after a warranty claim is filed and must surrender the component(s) at the request of Eccotemp.

Both Eccotemp and the Owner of the Product are bound by this Limited Warranty.

IV. MAKING A WARRANTY CLAIM

To make a warranty claim through this Limited Warranty, the Owner must contact Eccotemp's Customer Service team at support@eccotemp.com, schedule a call or live chat on the Eccotemp support page at <http://support.eccotemp.com>. It is within Eccotemp's sole discretion when a repair, replacement, or refund will be issued. Any return for refund must be approved by Eccotemp's Customer Service team prior to shipping the Product back to Eccotemp. Please refer to Returning Your Product For Repair or Refund Policy provided with the Product.

IV. MAKING A WARRANTY CLAIM, CONT'D...

Within the first 45 days of purchase, Eccotemp will cover all ground shipping costs for warranty related issues in the US and Canada, excluding Alaska, Hawaii and any location outside of the continental US and Canada. After the first 45 days of purchase, the Owner is responsible for all shipping to Eccotemp, regardless of reason or circumstance. Eccotemp will cover the warranty related shipping costs when returning the Product to the Owner after repair/inspection.

The method for warranty related shipping will be ground equivalent with the provider within Eccotemp's sole discretion.

What information you will need for processing of your warranty claim:

- Proof of purchase
- Serial number
- Photos of the installation
- Photos of the damage point (if there is one)

All shipments of any type of product coming to Eccotemp for any reason must have a Return Goods Authorization ("RGA") number for any repairs to be made. Please contact Eccotemp to obtain an RGA number prior to shipping anything to Eccotemp. Failure to do so could result in loss of Product. Eccotemp will not be responsible for replacement due to loss or damage if these steps are not properly followed.

Any returns to Eccotemp must be sent in the original packaging. If your returned product does not have the original packaging and/or is missing any of the components that came with the product, there will be a nonnegotiable 15% restock fee.

V. DISCLAIMER OF WARRANTIES AND RESPONSIBILITY FOR DAMAGES

EXCEPT AS PROVIDED IN THIS LIMITED WARRANTY, ECCOTEMP MAKES NO WARRANTY, EXPRESS OR IMPLIED, TO ANYONE AS TO FITNESS FOR ANY PURPOSE, MERCHANTABILITY, DESIGN, CONDITION, CAPACITY, PERFORMANCE, OR ANY OTHER ASPECT OF THE PRODUCT OR ITS MATERIAL OR WORKMANSHIP. ALL IMPLIED WARRANTIES WHICH MAY EXIST, NOTWITHSTANDING THIS DISCLAIMER, ARE LIMITED TO THE DURATION OF THIS LIMITED WARRANTY. THIS LIMITED WARRANTY IS MADE IN LIEU OF ALL OTHER GUARANTEES, WARRANTIES, REPRESENTATIONS, CONDITIONS, OBLIGATIONS, OR LIABILITIES, EXPRESS OR IMPLIED.

ECCOTEMP SHALL NOT BE LIABLE, EITHER IN CONTRACT OR TORT, FOR ANY DIRECT, INDIRECT, INCIDENTAL OR CONSEQUENTIAL DAMAGES, OR ANY LOSS, DAMAGE, OR INJURY TO PERSONS, INCLUDING DEATH, PROPERTY, OR THINGS, OR FOR DAMAGES OF ANY KIND OR NATURE INCLUDING BUSINESS INTERRUPTION, INCONVENIENCE OR LOSS OF ANTICIPATED PROFITS OR SAVINGS OCCASIONED BY OR ARISING OUT OF THE USE, MISUSE, NONUSE, REPAIR, REPLACEMENT OR DELAY IN DELIVERY OF THE PRODUCT. ECCOTEMP SHALL NOT BE LIABLE FOR THE COST OF ANY WORK DONE BY PURCHASER OR OTHERS TO THE PRODUCT.

This Limited Warranty gives specific legal rights. Some jurisdictions do not allow the exclusion or limitation of implied warranties or incidental or consequential damages. In such jurisdictions, the limitations or exclusions do not apply to the Owner. The Owner may also have other rights that may vary by jurisdiction.

VI. EXCLUSIONS

The following exclusions apply to this Limited Warranty:

1. A repair, replacement, or refund will not be provided under this Limited Warranty unless the Product containing the defective component is properly installed and maintained according to Eccotemp's Installation Manual and Use & Care Manual and in compliance with all applicable federal, state/province, and local laws, regulations, codes, policies, and licensing requirements. Any abuse, misuse, alteration, neglect, or misapplication of the Product will render this Limited Warranty null and void.
2. A repair, replacement, or refund will not be provided if the Product is damaged by services performed by third party service providers other than Eccotemp Systems.
3. Eccotemp systems is not responsible for any expenses arising from labor services, including but not limited to, installation or removal services due to a warranty claim.
4. A repair, replacement, or refund will not be provided if the Product is used in a hot water circulation loop, in series with a circulation system, where an on-demand recirculation system is incorporated, or in any other corrosive or otherwise destructive environment where the Product is not intended to be used as set forth in Eccotemp's Installation Manual and Use & Care Manual.
5. A repair, replacement, or refund will not be provided if the Product is damaged as a result of improper installation, including improper ventilation materials, sizing, length, elevation, condensation drainage, or inadequate airflow.
6. A repair, replacement, or refund will not be provided if the Product is damaged as a result of improper use, including freezing within the unit or surrounding piping, incorrect sizing for the application, scale build up, or incorrect gas and/or water pressure.
7. This Product shall not be used as a pool or spa heater. Use of the Product as a pool or spa heater shall be considered misuse and will render this Limited Warranty null and void.
8. A repair, replacement, or refund will not be provided if the Product is damaged by the use of non-potable, untreated or poorly treated well water, or water with high PH levels or hardness levels in excess of 12 grains per gallon (200 mg/L).
9. A repair, replacement, or refund will not be provided under this Limited Warranty if the original serial number on the Product has been removed or altered in a way that causes the serial number to not be readily determined.
10. Eccotemp will not pay electricity or fuel costs, or increases in electricity or fuel costs, for any reason whatsoever, including additional or unusual use of supplemental electrical heat.
11. Eccotemp will not be responsible for any default or delay in performance under this Limited Warranty caused by any factor or contingency outside of its control.

VII. MISCELLANEOUS

No agent, employee or representative of Eccotemp has any authority to bind Eccotemp to any representation or warranty concerning the Product not contained in this Limited Warranty. Eccotemp reserves the right and authority to change, modify or alter this warranty at any given time.

VIII. FOR CUSTOMERS WITH A HOME WARRANTY

Often your home warranty will assist in covering some of the fees related to your home appliances, such as your water heater. Be sure to check with your home warranty company for assistance prior to reaching out to Eccotemp.

PORTABLE PRODUCT COMPARISONS

ENGLISH

PRODUCT COMPARISON

EL5

EL7

EL10

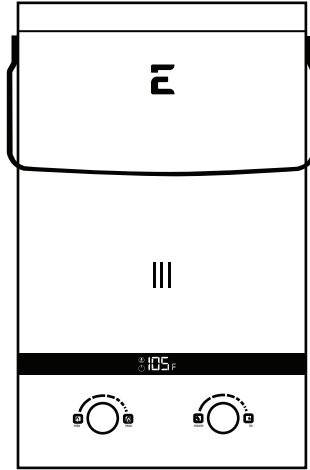
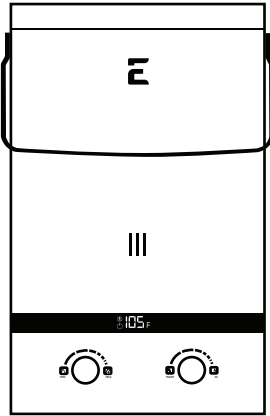
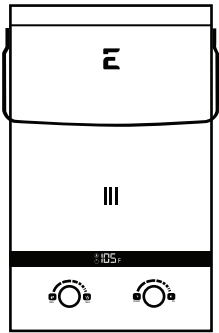

ECCOTEMP™
HEATING WATER SMARTER

	EL5	EL7	EL10
INSTALLATION	OUTDOOR ONLY	OUTDOOR ONLY	OUTDOOR ONLY
🔥 BTU	25,000 - 37,500	47,800 - 52,500	24,000 - 70,000
💧 Flow Rate	Rated 1.5 GPM	Rated 1.85 GPM	Rated 2.65 GPM
📦 Portable	Yes	Yes	Yes
⚡ Power Source	4 "AA" Cell Batteries	4 "AA" Cell Batteries	4 "AA" Cell Batteries
🔥 Gas Type	Liquid Propane Only	Liquid Propane Only	Liquid Propane Only
⚙️ Venting	None Needed	None Needed	None Needed
💧 Water Pressure	20-80 PSI	20-80 PSI	20-80 PSI
🔗 Regulator & Hose	Standard / Included	Standard / Included	Standard / Included
🌡️ Temperature Control	Manual 80	Manual 80	Manual 80
🛡️ Warranty	2 Years	2 Years	2 Years
📏 Product Dimensions	15.9" x 11.4" x 4.8" - 11.2 lbs	19.1" x 11.9" x 7.1" - 14.7 lbs	*26" x 13.6" x 6.5" - 22.8 lbs
📦 Package Dimensions	21.9" x 12.4" x 7.7" - 13.8 lbs	25.8" x 14" x 7.7" - 16 lbs	*35.4" x 15.7" x 9.6" - 28.4 lbs

*Subject to change

315-A INDUSTRIAL ROAD, SUMMERVILLE, SC 29483 | 1-866-356-1992

© Eccotemp 2022 All Rights Reserved | Printing Version CSA 2.0

PLEASE NOTE: THIS MODEL IS NOT RECOMMENDED, NOR HAS IT BEEN TESTED FOR ANY PERMANENT OR INDOOR INSTALLATION. THIS MODEL IS PART OF OUR PORTABLE, OUTDOOR SERIES AND NEEDS TO BE TAKEN DOWN AND STORED IN A WARM, DRY PLACE AFTER EVERY USE. THIS MANUAL AND ALL ECCOTEMP CONTENT IS SUBJECT TO CHANGE WITHOUT NOTICE. VISIT SUPPORT.ECCOTEMP.COM FOR THE LATEST VERSION OF THE MANUAL AND WARRANTY.