

**Bathroom Sink Faucet # N01020001U.. / N01020001U.. / N01020001U..**

| < 6 3/4 " > |

Bathroom Sink Faucet	Dimension	Weight	Order number
Ceramic cartridge			
<b>Colors</b>			
10 Chrome 46 Black Matte 70 Brushed Stainless Steel			
<b>Variant</b>			
Chrome, Height: 6 3/4 ", Flow rate: 1.2 gal/min, WaterSense: Yes, ADA: Yes, cUPC listed: Yes	2 "x6 3/4 "	3.439 lb	N01020001U..
Black Matte, Height: 6 3/4 ", Flow rate: 1.2 gal/min, WaterSense: Yes, ADA: Yes, cUPC listed: Yes	2 "x6 3/4 "	3.439 lb	N01020001U..
Stainless Steel Brushed, Height: 6 3/4 ", Flow rate: 1.2 gal/min, WaterSense: Yes, ADA: Yes, cUPC listed: Yes	2 "x6 3/4 "	3.439 lb	N01020001U..

All drawings contain the necessary measurements which are subject to standard tolerances. They are stated in inch & mm and are non-binding. Exact measurements, in particular for customized installation scenarios, can only be taken from the finished ceramic piece.

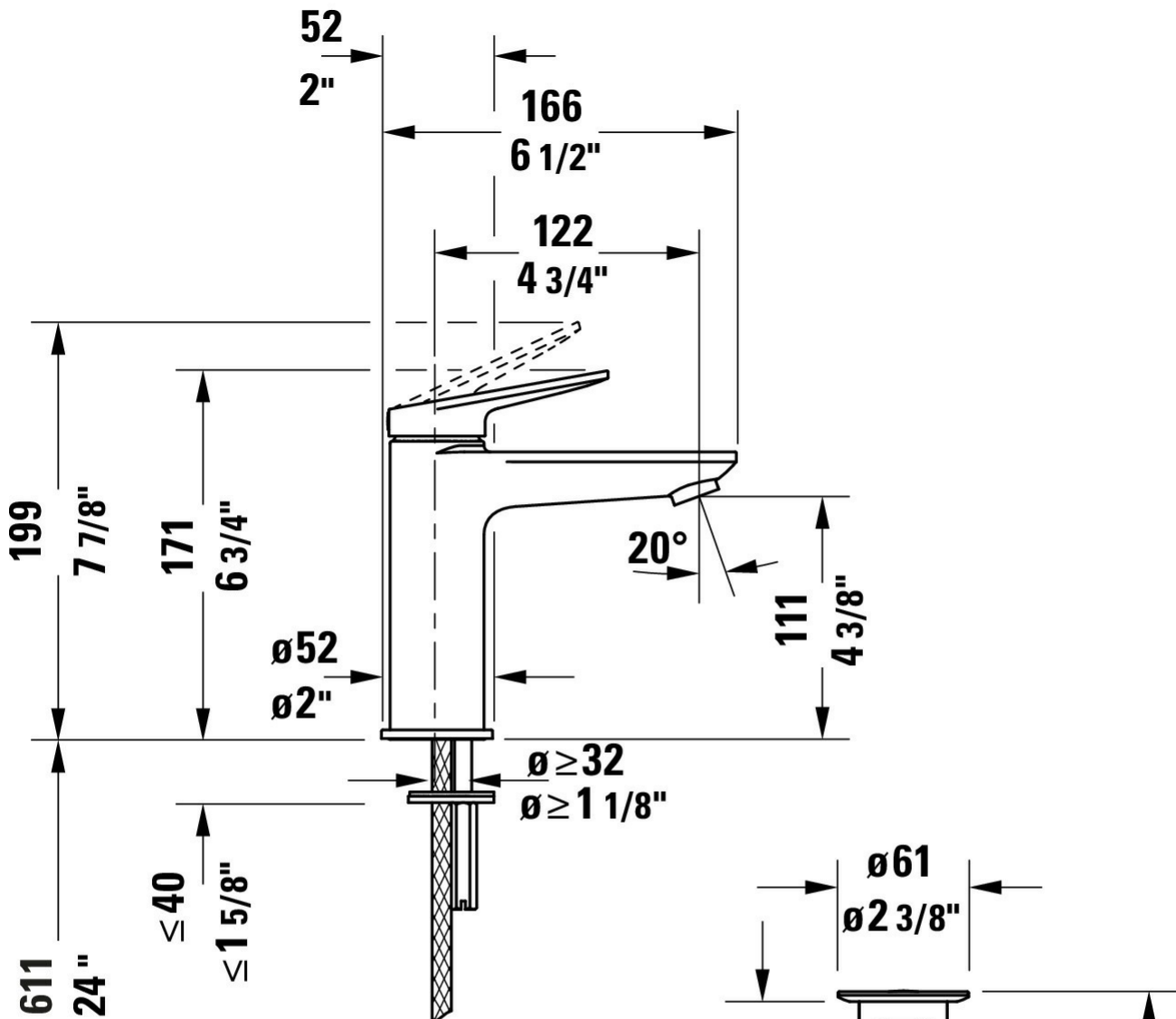

Bathroom Sink Faucet # N01020001U.. / N01020001U.. /  
N01020001U..

|< 6 3/4 " >|

