

Ventinox®

**Welded, flexible relining for
masonry chimney.**

UL 1777 and ULC S635.

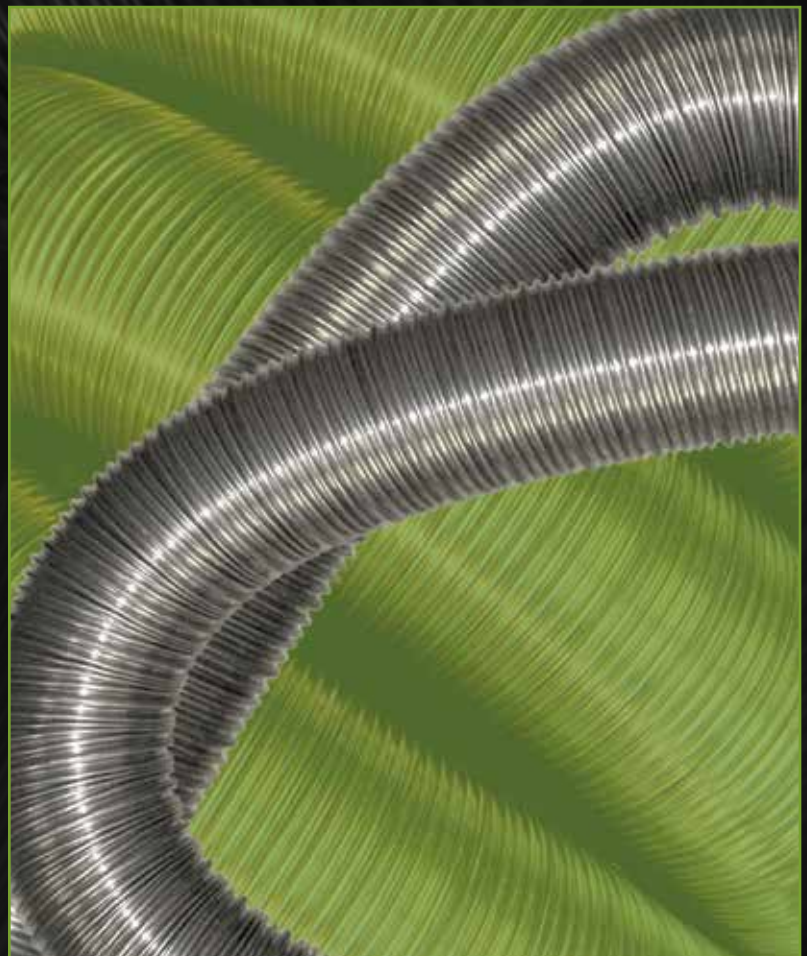

Specifications

Applications

VFT flexible liners are used for upgrading or restoring masonry chimneys that vent Category I natural gas, propane or oil appliances, wood or pellet stoves, fireplaces and fireplace inserts.

VG flexible liners are top performers when used to line masonry chimneys venting Category I gas-fired boilers, furnaces, space and water heaters.

Materials and Construction

VFT Single-wall, .006" 316 stainless steel. Continuous weld delivers a strong, air and water tight flue gas conduit.

VG Single-wall, .006" AL29-4C stainless steel. Continuous weld construction.

Clearances

VFT 0" clearance to masonry chimney for oil and gas. With TherMix or ProFoil insulation 0" clearance for solid fuels.

VG 0" clearance to masonry for gas appliances.

Diameters

3"-12"

Listings

UL Listed to UL 1777 and ULC S635 (MH11476).



UL 1777 and ULC S635 Systems

Ventinox[®]

Liner For Life

Ventinox VFT, made from 316Ti stainless steel, can withstand high temperatures associated with solid fuel fired heaters, as well as the corrosive environments typical in gas or oil vents. Tested and listed for all-fuel, and can also be used for wood, gas, or oil-fired equipment.

Ventinox VG is the ultimate choice for venting gas fired appliances, where highly corrosive condensate formation (hydrochloric acid) within the flue is likely. The super-ferritic AL29-4C stainless steel alloy exhibits extreme resistance to chloride pitting, crevice, and stress corrosion and cracking.

Ventinox components are made from either 316SS (VFT) or super-ferritic stainless steel (VG). Components feature an integral locking band, avoiding the use of pop rivets. Liners and components provide a penetration free top to bottom connection.

When venting solid fuel heaters, Ventinox VFT must be insulated with either TherMix or ProFoil blankets to meet UL 1777 requirements. For all other applications, insulation is highly recommended for increased efficiency and draft performance. See the end of the DuraFlex SS for the insulation section to find information on our offering: TherMix, ProFoil, AluFoil Tape and ProMesh.



Typical Installations

'updated installation key'

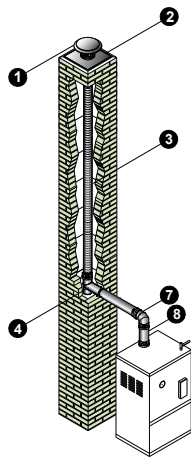

Gas Furnace

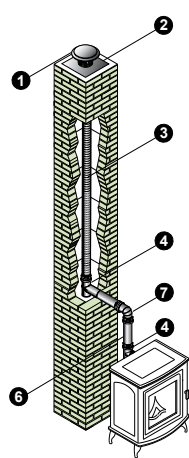

Gas Stove

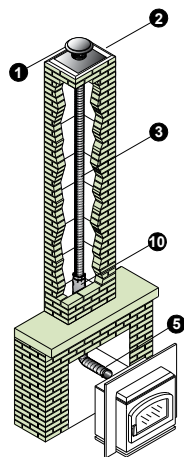

Fireplace Insert

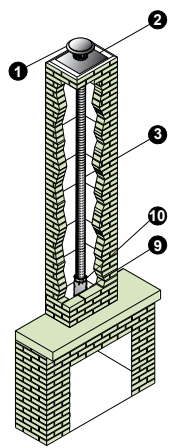

Open Fireplace

Installation Key

1	Rain Cap w/ Storm Collar
2	Top Cover Plate
3	Flex Length
4	Tee with Removable Snout
5	Sleeve
6	Rigid Type B Gas Vent or Rigid Pipe Length
7	Adjustable Elbow
8	DuraFlex Appliance Adapter
9	Bottom Plate w/ Collar
10	ProFoil w/ProMesh or Thermix

Refer to our Typical Venting Installation drawings to select the appropriate component parts for your installation.

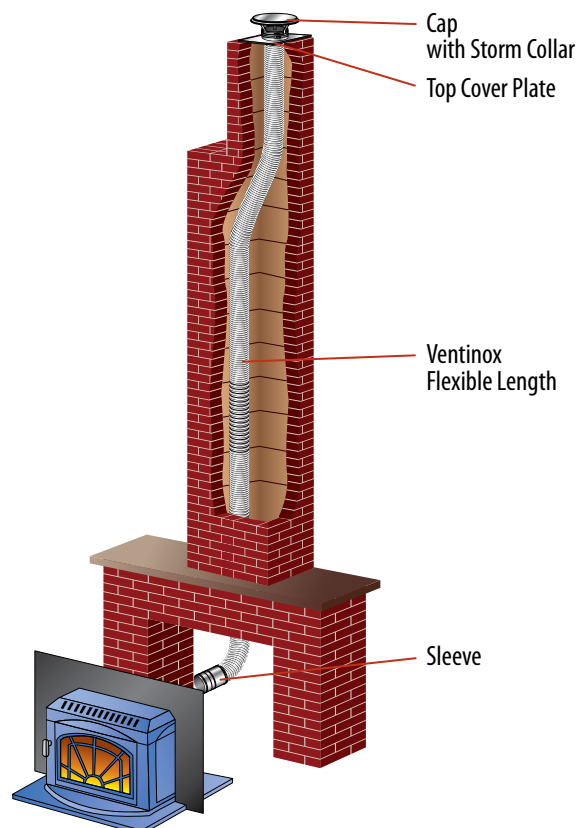

Planning Your Installation

1	Verify the venting requirements of the appliance used. Choose the liner system appropriate for the appliance and installation. Note: VFT is recommended for all fuels and VG is the best choice for gas.
2	Refer to the Typical Installations for the type of liner installation similar to your situation. Identify the needed parts for installation.
3	Venting for a fireplace requires the correct liner size for proper drafting. The size of the liner should match the outlet size on the appliance.
4	Determined the length of the liner needed.
5	If connecting two or more appliances to a common vent, be sure to connect the higher BTU appliance below the lower BTU appliance.
6	Make sure of a proper fit for the top plate of the relining to provide a secure, leak-proof installation.
7	If a free standing appliance is used, select the vent or stovepipe pieces to connect from the appliance to the liner (refer to the appropriate DuraVent Catalog Section).
8	Important! Check to be sure the installation complies with all local and national code requirements, including clearances to combustibles. Contact the local building inspector for permit requirements.

Ventinox® Kits

Ventinox VFT Kit w/out Tee



Includes Ventinox VFT Liner, Top Plate, and Rain Cap with Storm Collar. Choose diameter and length needed.

SIZE	LENGTH	ORDER #	STOCK #	LENGTH	ORDER #	STOCK #
3"	25'	3VFT-25K	810001569	35'	3VFT-35K	810001570
4"	25'	4VFT-25K	810001571	35'	4VFT-35K	810001572
5"	25'	5VFT-25K	810001573	35'	5VFT-35K	810001574
5 1/2"	25'	55VFT-25K	810001575	35'	55VFT-35K	810001576
6"	25'	6VFT-25K	810001577	35'	6VFT-35K	810001578
7"	25'	7VFT-25K	810001579	35'	7VFT-35K	810001580
8"	25'	8VFT-25K	810001581	35'	8VFT-35K	810001582

Ventinox VFT Kit w/ Tee



Includes Ventinox VFT Liner, Top Plate, Rain Cap with Storm Collar, Tee with Removable Snout, and Tee Cap. Choose diameter and length needed.

SIZE	LENGTH	ORDER #	STOCK #	LENGTH	ORDER #	STOCK #
3"	25'	3VFT-25KT	810001583	35'	3VFT-35KT	810001584
4"	25'	4VFT-25KT	810001585	35'	4VFT-35KT	810001586
5"	25'	5VFT-25KT	810001587	35'	5VFT-35KT	810001588
5 1/2"	25'	55VFT-25KT	810001589	35'	55VFT-35KT	810001590
6"	25'	6VFT-25KT	810001591	35'	6VFT-35KT	810001592
7"	25'	7VFT-25KT	810001593	35'	7VFT-35KT	810001594
8"	25'	8VFT-25KT	810001595	35'	8VFT-35KT	810001596

Ventinox® VFT & VG

Ventinox VFT Extensions



Use as an economical solution to add a few extra feet when needed to complete a run. Available in 5' and 10' lengths.

SIZE	LENGTH	ORDER #	STOCK #	LENGTH	ORDER #	STOCK #
3"	5'	3VFT-X5	810001612	10'	3VFT-X10	810001613
4"	5'	4VFT-X5	810001628	10'	4VFT-X10	810001629
5"	5'	5VFT-X5	810001647	10'	5VFT-X10	810001648
5 1/2"	5'	55VFT-X5	810001665	10'	55VFT-X10	810001666
6"	5'	6VFT-X5	810001680	10'	6VFT-X10	810001681
7"	5'	7VFT-X5	810001711	10'	7VFT-X10	810001712
8"	5'	8VFT-X5	810001735	10'	8VFT-X10	810001736

Ventinox VFT



Used for upgrading or restoring masonry chimneys that vent Category I natural gas, propane or oil appliances, wood or pellet stoves, fireplaces and fireplace inserts. Single-wall, .006" 316 Ti (Titanium) stainless steel. Continuous weld delivers a strong, air and water tight flue gas conduit. Custom lengths available using XX stock#'s. (e.g.: For a 9" diameter, 40' length stock# would be QTY 40 of 9VFT-XX).

SIZE	LENGTH	ORDER #	STOCK #	SIZE	ORDER #	STOCK #
3"	25	3VFT-25BL	810001614	3"	3VFT-XX	810001611
4"	25	4VFT-25BL	810001630	4"	4VFT-XX	810001627
5"	25	5VFT-25BL	810001649	5"	5VFT-XX	810001646
5 1/2"	25	55VFT-25BL	810001667	5 1/2"	55VFT-XX	810001664
6"	25	6VFT-25BL	810001682	6"	6VFT-XX	810001679
7"	25	7VFT-25BL	810001713	7"	7VFT-XX	810001710
8"	25	8VFT-25BL	810001737	8"	8VFT-XX	810001734
3"	35	3VFT-35BL	810001615	9"	9VFT-XX	810001763
4"	35	4VFT-35BL	810001631	10"	10VFT-XX	810001778
5"	35	5VFT-35BL	810001650	11"	11VFT-XX	810001795
5 1/2"	35	55VFT-35BL	810001668	12"	12VFT-XX	810001808
6"	35	6VFT-35BL	810001683			
7"	35	7VFT-35BL	810001714			
8"	35	8VFT-35BL	810001738			

Ventinox VG



Used to line masonry chimneys venting Category I, natural gas, propane, furnaces, space and water heaters. Single-wall, .006" AL29-4C stainless steel. Continuous weld construction. Custom lengths available using XX stock#'s. (e.g.: For a 7" diameter, 40' length stock# would be QTY 40 of 7VG-XX).10", 11", & 12" VG liners are only available in 10' and 20' lengths.

SIZE	ORDER #	STOCK #	SIZE	ORDER #	STOCK #
3"	3VG-XX	810001826	8"	8VG-XX	810001868
4"	4VG-XX	810001834	9"	9VG-XX	810001877
5"	5VG-XX	810001842	10"	10VG-XX	810001884
6"	6VG-XX	810001851	11"	11VG-XX	810001891
7"	7VG-XX	810001860	12"	12VG-XX	810001900

Coupler

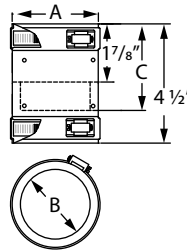

Use as a drip free connection between two sections of liner.

SIZE	VFT		VG		A	B	C
	ORDER #	STOCK #	ORDER #	STOCK #			
3"	3VFT-C	810001616	3VG-C	810001827	3 3/8"	3"	3 1/2"
4"	4VFT-C	810001632	4VG-C	810001835	4 3/8"	3 3/4"	3 1/2"
5"	5VFT-C	810001651	5VG-C	810001843	5 3/8"	4 3/4"	3 1/2"
5 1/2"	55VFT-C	810001669	--	--	5 3/4"	4 7/8"	3 1/2"
6"	6VFT-C	810001684	6VG-C	810001852	6 5/2"	5 5/8"	3 1/2"
7"	7VFT-C	810001715	7VG-C	810001861	7 1/2"	6 9/16"	3 1/2"
8"	8VFT-C	810001739	8VG-C	810001869	8 5/2"	7 7/8"	3 1/2"
9"	9VFT-C	810001764	9VG-C	810001878	9 3/8"	8 3/4"	3 5/8"
10"	10VFT-C	810001779	10VG-C	810001885	10 3/8"	9 3/4"	3 5/8"
11"	11VFT-C	810001796	11VG-C	810001892	11 1/2"	10 7/8"	3 5/8"
12"	12VFT-C	810001809	12VG-C	810001901	12 3/16"	11 11/16"	3 5/8"

4" Ventinox Short Body Tee w/ 3" Branch



Used to connect flex to pellet insert. Use as a 90° transition between liner and connector pipe at the wall thimble or rear flue outlet of a pellet appliance. Transition from 3" PelletVent to 4" Ventinox Chimney Liner. Tee is 9" tall. Comes with Clean-Out Cap.

SIZE	ORDER #	STOCK #
4"	4VFT-PVTS	810001640

Sleeve

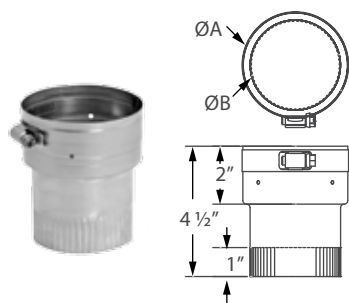

Use to connect a liner into an appliance flue collar.

SIZE	VFT		VG		A	B
	ORDER #	STOCK #	ORDER #	STOCK #		
3"	3VFT-S	810001617	3VG-S	810001828	3 1/2"	3"
4"	4VFT-S	810001633	4VG-S	810001836	4 1/2"	4"
5"	5VFT-S	810001652	5VG-S	810001844	5 1/2"	5"
5 1/2"	55VFT-S	810001670	--	--	5 3/4"	6"
6"	6VFT-S	810001685	6VG-S	810001853	6 1/2"	6"
7"	7VFT-S	810001716	7VG-S	810001862	7 1/2"	7"
8"	8VFT-S	810001740	8VG-S	810001870	8 3/10"	8"
9"	9VFT-S	810001765	9VG-S	810001879	9 3/10"	9"
10"	10VFT-S	810001780	10VG-S	810001886	10 3/10"	10"
11"	11VFT-S	810001797	11VG-S	810001893	11 1/2"	11"
12"	12VFT-S	810001810	12VG-S	810001902	12 1/4"	12"

45° Adjustable Elbow

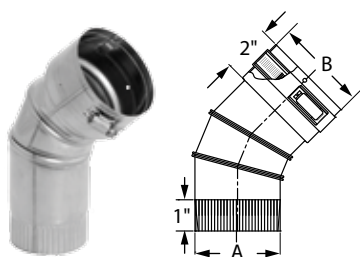

Use as a straight or up to 45° connection between liner and appliance flue collar.

SIZE	VFT		VG		A	B
	ORDER #	STOCK #	ORDER #	STOCK #		
3"	3VFT-E45	810001618	3VG-E45	810001829	3"	3 1/2"
4"	4VFT-E45	810001634	4VG-E45	810001837	4"	4 1/2"
5"	5VFT-E45	810001653	5VG-E45	810001845	5"	5 1/2"
5 1/2"	55VFT-E45	810001671	--	--	6"	5 3/4"
6"	6VFT-E45	810001686	6VG-E45	810001854	6"	6 1/2"
7"	7VFT-E45	810001717	7VG-E45	810001863	7"	7 1/2"
8"	8VFT-E45	810001741	8VG-E45	810001871	8"	8 3/10"
9"	9VFT-E45	810001766	9VG-E45	810001880	9"	9 3/10"
10"	10VFT-E45	810001781	10VG-E45	810001887	10"	10 3/10"
11"	11VFT-E45	810001798	11VG-E45	810001894	11"	11 1/2"
12"	12VFT-E45	810001811	12VG-E45	810001903	12"	12 1/4"

90° Adjustable Elbow

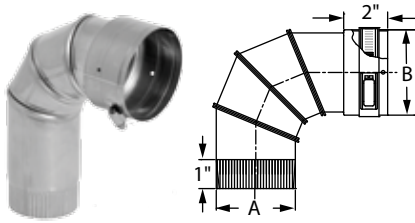

Use as a straight or up to 90° connection between liner and appliance flue collar.

SIZE	VFT		VG		A	B
	ORDER #	STOCK #	ORDER #	STOCK #		
3"	3VFT-E90	810001619	3VG-E90	810001830	3"	3 1/3"
4"	4VFT-E90	810001635	4VG-E90	810001838	4"	4 1/3"
5"	5VFT-E90	810001654	5VG-E90	810001846	5"	5 1/3"
5 1/2"	55VFT-E90	810001672	--	--	6"	5 3/4"
6"	6VFT-E90	810001687	6VG-E90	810001855	6"	6 1/3"
7"	7VFT-E90	810001718	7VG-E90	810001864	7"	7 1/2"
8"	8VFT-E90	810001742	8VG-E90	810001872	8"	8 3/10"
9"	9VFT-E90	810001767	9VG-E90	810001881	9"	9 3/10"
10"	10VFT-E90	810001782	10VG-E90	810001888	10"	10 3/10"
11"	11VFT-E90	810001799	11VG-E90	810001895	11"	11 1/2"
12"	12VFT-E90	810001812	12VG-E90	810001904	12"	12 1/4"

Tee w/ Removable Snout

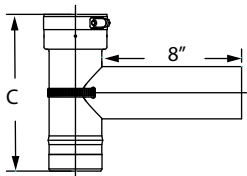
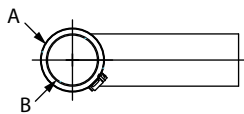

Use as a 90° transition between liner and connector pipe at the wall thimble or rear flue outlet of a heater. Removable Snout with internal draw band allows for easier, through the wall thimble installation. 5 1/2" diameter has a 6" branch.

SIZE	VFT		VG		A	B	C
	ORDER #	STOCK #	ORDER #	STOCK #			
3"	3VFT-TRS	810001620	3VG-TRS	810001831	3 3/5"	3"	9"
4"	4VFT-TRS	810001636	4VG-TRS	810001839	4 3/8"	4"	10"
5"	5VFT-TRS	810001655	5VG-TRS	810001847	5 3/8"	5 1/4"	10 1/2"
5 1/2"	55VFT-TRS	810001673	--	--	5 3/4"	5 5/8"	12"
6"	6VFT-TRS	810001688	6VG-TRS	810001856	6 3/8"	6 2/5"	12"
7"	7VFT-TRS	810001719	7VG-TRS	810001865	7 7/16"	7 2/5"	13 1/2"
8"	8VFT-TRS	810001743	8VG-TRS	810001873	8 1/3"	8 1/5"	14 1/2"
9"	9VFT-TRS	810001768	9VG-TRS	810001882	9 1/3"	9 1/5"	15 1/2"
10"	10VFT-TRS	810001783	10VG-TRS	810001889	10 3/10"	10 1/5"	16 1/2"
11"	11VFT-TRS	810001800	11VG-TRS	810001896	11 1/2"	11"	17 1/2"
12"	12VFT-TRS	810001813	12VG-TRS	810001905	12 1/4"	12"	18"

Tee Cover

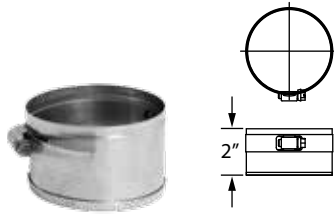

Attach to bottom of tee body. Provides access for cleaning.

SIZE	VFT		VG	
	ORDER #	STOCK #	ORDER #	STOCK #
3"	3VFT-TCV	810001621	3VG-TCV	810001832
4"	4VFT-TCV	810001637	4VG-TCV	810001840
5"	5VFT-TCV	810001656	5VG-TCV	810001848
5 1/2"	55VFT-TCV	810001674	--	--
6"	6VFT-TCV	810001689	6VG-TCV	810001857
7"	7VFT-TCV	810001720	7VG-TCV	810001866
8"	8VFT-TCV	810001744	8VG-TCV	810001874
9"	9VFT-TCV	810001769	9VG-TCV	810001883
10"	10VFT-TCV	810001784	10VG-TCV	810001890
11"	11VFT-TCV	810001801	11VG-TCV	810001897
12"	12VFT-TCV	810001814	12VG-TCV	810001906

VFT Long Tee Snout

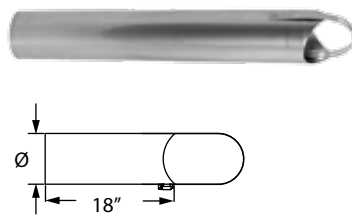

Use to increase reach through masonry at wall thimble.

SIZE	ORDER #	STOCK #	LENGTH	ORDER #	STOCK #
3"	3VFT-TLS	810001622	8"	8VFT-TLS	810001745
4"	4VFT-TLS	810001638	9"	9VFT-TLS	810001770
5"	5VFT-TLS	810001657	10"	10VFT-TLS	810001785
6"	6VFT-TLS	810001690	11"	11VFT-TLS	810001802
7"	7VFT-TLS	810001721	12"	12VFT-TLS	810001815

Swivel Tee Adapter

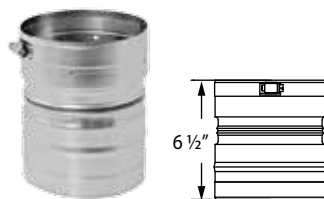

Use as connector between liner and Tee. Allows tee body to be rotated at wall thimble.

SIZE	ORDER #	STOCK #
5"	5VFT-ADST	810001658
6"	6VFT-ADST	810001691
7"	7VFT-ADST	810001722
8"	8VFT-ADST	810001746

Rain Cap w/ Storm Collar



Use to support liner from the top and form a seal between the Storm Collar and the Top Plate. Top is removable for easy access to chimney cleaning. Top photo shows 3"-8" diameter style, bottom photo 9"-12" diameters.

SIZE	ORDER #	STOCK #	A	B
3"	3VFT-RCSC	810001623	8"	5"
4"	4VFT-RCSC	810001641	8"	5"
5"	5VFT-RCSC	810001659	11"	6"
5 1/2"	55VFT-RCSC	810001675	--	--
6"	6VFT-RCSC	810001692	11"	6"
7"	7VFT-RCSC	810001723	15"	6"
8"	8VFT-RCSC	810001747	15"	6"
9'	9VFT-RCSC	810001771	--	6"
10"	10VFT-RCSC	810001786	--	6"
11"	11VFT-RCSC	810001803	--	6"
12"	12VFT-RCSC	810001816	--	6"

Bird Screen

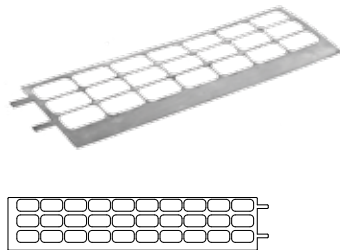

Use to add a bird screen to a standard Rain Cap.

SIZE	ORDER #	STOCK #	LENGTH	ORDER #	STOCK #
3"	3VFT-BS	810001624	8"	8VFT-BS	810001749
4"	4VFT-BS	810001642	9'	9VFT-BS	810001772
5"	5VFT-BS	810001661	10"	10VFT-BS	810001787
5 1/2"	55VFT-BS	810001676	11"	11VFT-BS	810001804
6"	6VFT-BS	810001694	12"	12VFT-BS	810001817
7"	7VFT-BS	810001725			

Top Cover Plate

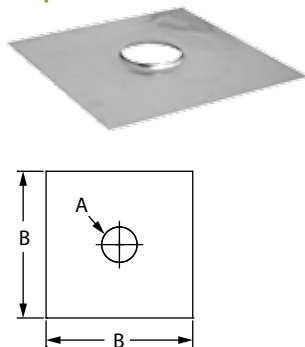

Use to close the top of a masonry chimney and to provide support for the liner.

SIZE	ORDER #	STOCK #	A	B
3"	3VFT-TP	810001625	3 3/16"	16"
4"	4VFT-TP	810001643	4 3/16"	16"
5"	5VFT-TP	810001662	5 3/16"	16"
5 1/2"	55VFT-TP	810001677	5 4/5"	16"
6"	6VFT-TP	810001695	6 3/16"	16"
7"	7VFT-TP	810001726	7 3/16"	16"
8"	8VFT-TP	810001750	8 3/16"	16"
9'	9VFT-TP	810001773	9 3/16"	18"
10"	10VFT-TP	810001788	10 3/16"	18"
11"	11VFT-TP	810001805	11 3/16"	18"
12"	12VFT-TP	810001818	12 3/16"	18"

Bottom Plate w/ Collar

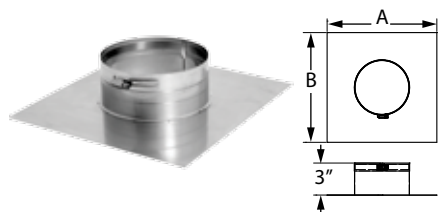

Attach to bottom of liner in the smoke chamber of a fire place, then pull up to form a seal between the liner and clay tile.

SIZE	ORDER #	STOCK #	A x B
6"	6VFT-BP	810001696	12" x 13"
7"	7VFT-BP	810001727	12" x 13"
8"	8VFT-BP	810001751	12" x 13"
9'	9VFT-BP	810001774	14" x 16"

Offset Slide Adapter



Use as a horizontally adjustable connector between a liner and top flue outlet of a heater. Adds up to 5" of offset.

SIZE	ORDER #	STOCK #	A
6"	6VFT-ADSL	810001697	2 3/4"
8"	8VFT-ADSL	810001752	3 1/4"

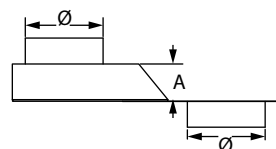

Installation Cone

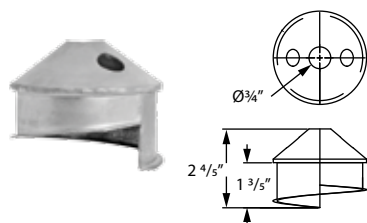

Use with a rope to pull liner through offsets in masonry chimney. Twists into liner.

SIZE	ORDER #	STOCK #	LENGTH	ORDER #	STOCK #
3"	3VFT-IC	810001626	8"	8VFT-IC	810001758
4"	4VFT-IC	810001644	9"	9VFT-IC	810001776
5"	5VFT-IC	810001663	10"	10VFT-IC	810001791
5 1/2"	55VFT-IC	810001678	11"	11VFT-IC	810001807
6"	6VFT-IC	810001702	12"	12VFT-IC	810001819
7"	7VFT-IC	810001729			

Round-to-Oval Flex Connector



Use to connect round portion of this connector to round liner. Oval portion of connector fits through fireplace dampers.

SIZE	ORDER #	STOCK #
6" x 48"	6VFT-48ROFC	810001705
6" x 57"	6VFT-57ROFC	810001706
7" x 57"	7VFT-57ROFC	810001732
8" x 48"	8VFT-48ROFC	810001761
8" x 57"	8VFT-57ROFC	810001762
10" x 57"	10VFT-57ROFC	810001794

Oval Flex Connector



Use as a flex connector between the top of a fireplace insert and the bottom of a clay tile. See kits for details.

SIZE	ORDER #	STOCK #	LENGTH	ORDER #	STOCK #
6" x 48"	6VFT-480FC	810001703	8" x 57"	8VFT-570FC	810001760
6" x 57"	6VFT-570FC	810001704	9" x 48"	9VFT-480FC	810001777
7" x 48"	7VFT-480FC	810001730	10" x 48"	10VFT-480FC	810001792
7" x 57"	7VFT-570FC	810001731	10" x 57"	10VFT-570FC	810001793
8" x 48"	8VFT-480FC	810001759			

Sealing Kits

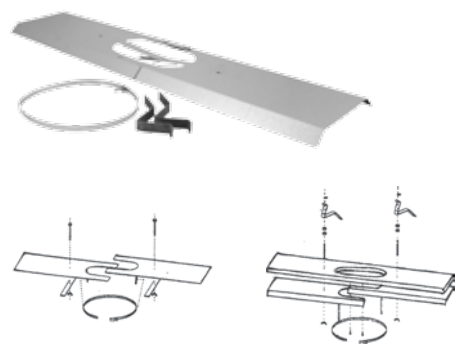

VSK Damper Sealing Kit

VCK Connector Sealing Kit

Use to seal damper. The VSK Damper Sealing Kit rests on top of the fireplace damper frame and seals the area around the Oval Flex Connector. Kit includes 2 panels, cross-bars to tighten against the damper frame for a secure fit and wing nuts. Fits up to 49" wide dampers. The VCK Connector Sealing Kit fits underneath the damper frame and seals the area around the Oval Flex Connector. Kit includes 2 plates, an insulation panel, support bars with hardware, connector and wing nuts. First up to 48" wide dampers.

SIZE	ORDER #	STOCK #
6"-10"	6VFT-VSK	810001610
6"-10"	6VFT-VCK	810001609

VG Universal Take-off

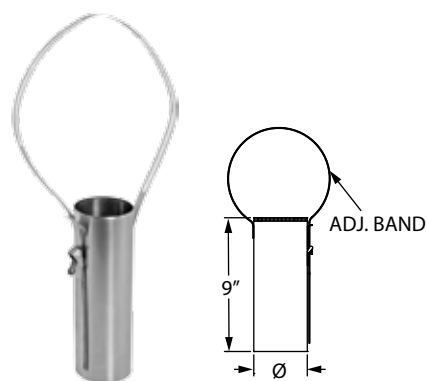

Use to connect additional appliances into a common vent.

SIZE	ORDER #	STOCK #
3"	3VG-UTO	810001833
4"	4VG-UTO	810001841
5"	5VG-UTO	810001849
6"	6VG-UTO	810001858

3"- 4" Pellet Step Increaser



Use to connect 4" diameter Ventinox flex to a 3" diameter pellet insert.

SIZE	ORDER #	STOCK #
4"	3VFT-X4	810001645

VG Increaser/Reducer

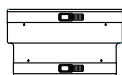

Use to increase or decrease vent diameters . Additional sizes available through special order.

SIZE	ORDER #	STOCK #
6" - 5"	5VG-X6	810001850
7" - 8"	7VG-X8	810001867
9" - 8"	8VG-X9	810001875
7" - 6"	7VG-X6	810001859

Round Insert Boot

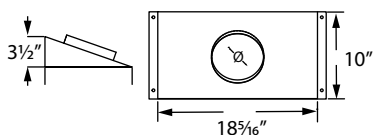

Use to connect inserts with either rectangular or round flue collars to 6" or 8" liners. Made from 11 gauge carbon steel.

SIZE	ORDER #	STOCK #
6 1/2"	6VFT-RB	810001698
8 1/2"	8VFT-RB	810001753

Oval Insert Boot

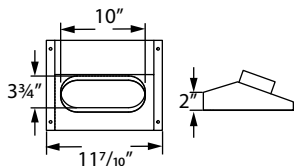

Use to connect inserts with 5" to 8" round flue collars to 8" Oval Flex Connectors. Made from 11 gauge carbon steel.

SIZE	ORDER #	STOCK #
8"	8VG-OB	810001876

Oval Adjustable Insert Boot

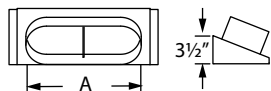

Use to connect inserts with rectangular flue outlets to Oval Flex Connectors. Top plate can point straight up or back towards the damper. Made from 11 gauge carbon steel.

SIZE	ORDER #	STOCK #	A
8"	8VFT-OB	810001754	11"
10"	10VFT-OB	810001789	14"

Round-to-Oval Adapter



Use as a drip-free connection between a oval liner and Round Flex Connector.

SIZE	ORDER #	STOCK #
6" x 6"	6VFT-6ADRO	810001699
6" x 7"	6VFT-X7ADRO	810001700
6" x 8"	6VFT-X8ADRO	810001701
7" x 8"	7VFT-X8ADRO	810001728
8" x 8"	8VFT-8ADRO	810001755
8" x 9"	8VFT-X9ADRO	810001756
8" x 10"	8VFT-X10ADRO	810001757
9" x 10"	9VFT-X10ADRO	810001775
10" x 10"	10VFT-10ADRO	810001790

Oval-to-Round Adapter



Use as a drip-free connection between a round liner and Oval Flex Connector.

SIZE	ORDER #	STOCK #
6" x 6"	6VFT-6ADOR	810001707
7" x 7"	7VFT-7ADOR	810001733
6" x 7" 30° ANGLE	6VFT-X7ADOR30	810001708
6" x 7"	6VFT-X7ADOR	810001709

Insulation

TherMix



Use to fill space between a liner and inside masonry chimney. Ready-mix formula cures into lightweight, semi-hard mass that insulates the liner and dissipates the intense heat created in a chimney fire.

*Use Table 1 to estimate the number of TherMix bags or boxes needed to do the job.

- Find the flue opening that comes closest to the one being lined, the left hand column.
- Find the size of the liner to be installed across the top line.
- Where the values intersect, read the cubic foot volume of TherMix per foot of chimney height.
- Multiply this volume by the height (in feet) of the chimney.
- Divide the cubic feet calculated in the previous step by 3.25. This answer will determine the number of bags/boxes of TherMix needed.

SIZE	ORDER #	STOCK #
BAG	RNS-TMG	810001820
BOX	RNS-TMX	810001821

Example:

A 28' chimney with a flue opening of 8.5" x 8.5" is to be lined with a 6" liner. As shown in Table 1, .30ft³ of TherMix is needed per foot of chimney height. Multiply .30 by 28 (the height of the chimney), to get 8.4ft³. Now divide 8.4 by 3.25 (the approximate volume yield per bag of TherMix), to obtain 2.6 bags/boxes of TherMix to complete the installation.

*Masonry chimneys are not uniform structures. Have extra bags/boxes available in case you need them. If there is an installation not covered by table 1, refer to the formula below:

$$\text{Packages of TherMix} = \frac{(W \times D \times H) - (CS \times H)}{1728 \text{ cu. in.}} \div 3.25$$

- W = Width of flue opening (in inches)
- D = Depth of flue opening (in inches)
- H = Height of flue (in inches)
- CS = Cross Section areas of chimney liner (table 2)

TABLE 1: THERMIX VOLUME PER ONE FOOT OF CHIMNEY HEIGHT

Flue Opening	Diameter of Liner					
	5"	6"	7"	8"	10"	12"
7.5" x 7.5"	.25	.20	--	--	--	--
7.5" x 11.5"	.46	.40	(Ovalized) .38	(Ovalized) .32	--	--
8.5" x 8.5"	.36	.30	.23	--	--	--
8.5" x 11.5"	.54	.48	.41	(Ovalized) .36	(Ovalized) .33	--
9.5" x 9.5"	.49	.43	.36	.27	--	--
11.5" x 11.5"	.78	.72	.65	.60	.37	--
11.5" x 16.5"	1.18	1.12	1.05	.96	.77	--
12.5" x 12.5"	.95	.88	.82	.73	.53	--
14.5" x 14.5"	1.30	1.26	1.20	1.10	.92	.65
14.5" x 18.5"	1.70	1.66	1.60	1.50	1.30	1.04

TABLE 2: CROSS SECTION AREA OF LINER

Liner Size	CS Area	Oval Liner Size	Oval Dimensions	CS Area
Round 5"	19.62in ²			
Round 6"	28.46in ²	Oval 6"	(4.2" x 7.2")	24.60in ²
Round 7"	38.46in ²	Oval 7"	(4.2" x 9.1")	32.20in ²
Round 8"	50.25in ²	Oval 8"	(4.2" x 10.3")	37.20in ²
Round 9"	62.50in ²			
Round 10"	78.50in ²	Oval 10"	(4.2" x 13.3")	49.50in ²
Round 12"	113.22in ²			

ProFoil



Use as insulator for stainless steel liners in masonry chimneys. UL Listed insulation. Size is based on vent diameter.

Required to insulate stainless steel liner to meet UL 1777 when proper clearances to chimney and framing are not available. 1" clearance from SS liner to interior wall of the masonry chimney and 1" clearance from the masonry to the house framing are required in order to meet UL 1777. If you do not have either of these clearances then a 1/2" wrap is required. If these two clearances are available then no insulation is needed. AluFoil Tape and ProMesh required.

SIZE	FITS Ø	THICKNESS	ORDER #	STOCK #
22"x25'	5"-5½"	½"	56RNS-PFB22X25	810001822
24"x25'	6"	½"	7RNS-PFB24X25	810001823
29"x25'	7"	½"	8RNS-PFB29X25	810001824
48"x25'	8"-12"	½"	912RNS-PFB48X25	810001825
DOUBLE WRAPPING 1/4" PROFOIL				
ProFoil Size	Single Wrap Liner Size	Double Wrap Liner Size		
22"x25"	3"-6"	3"-5"		
24"x25"	7"	6"		
29"x25"	8"	7"-8"		
48"x25"	9"-12"	9"-12"		

AluFoil Tape



Use to seal seams of ProFoil insulation. 2 mil aluminum foil tape has strength and adhesion.

SIZE	ORDER #	STOCK #
3" x 150'	RNS-ALF	810002486

ProMesh



Use to protect the ProFoil during installation. 304 stainless steel mesh slides over insulated liner. Shrinks to fit liner when pulled length-wise.

SIZE	ORDER #	STOCK #	LENGTH
SM 3"-6"Ø	RNS-PM1	810002487	50'
LG 7"-9"Ø	RNS-PM2	810002488	50'
XLG 10"-12"Ø	RNS-PM3	810002489	50'

What makes us different from the rest?

Ventinox: The optimum in safety and performance for flexible lining.

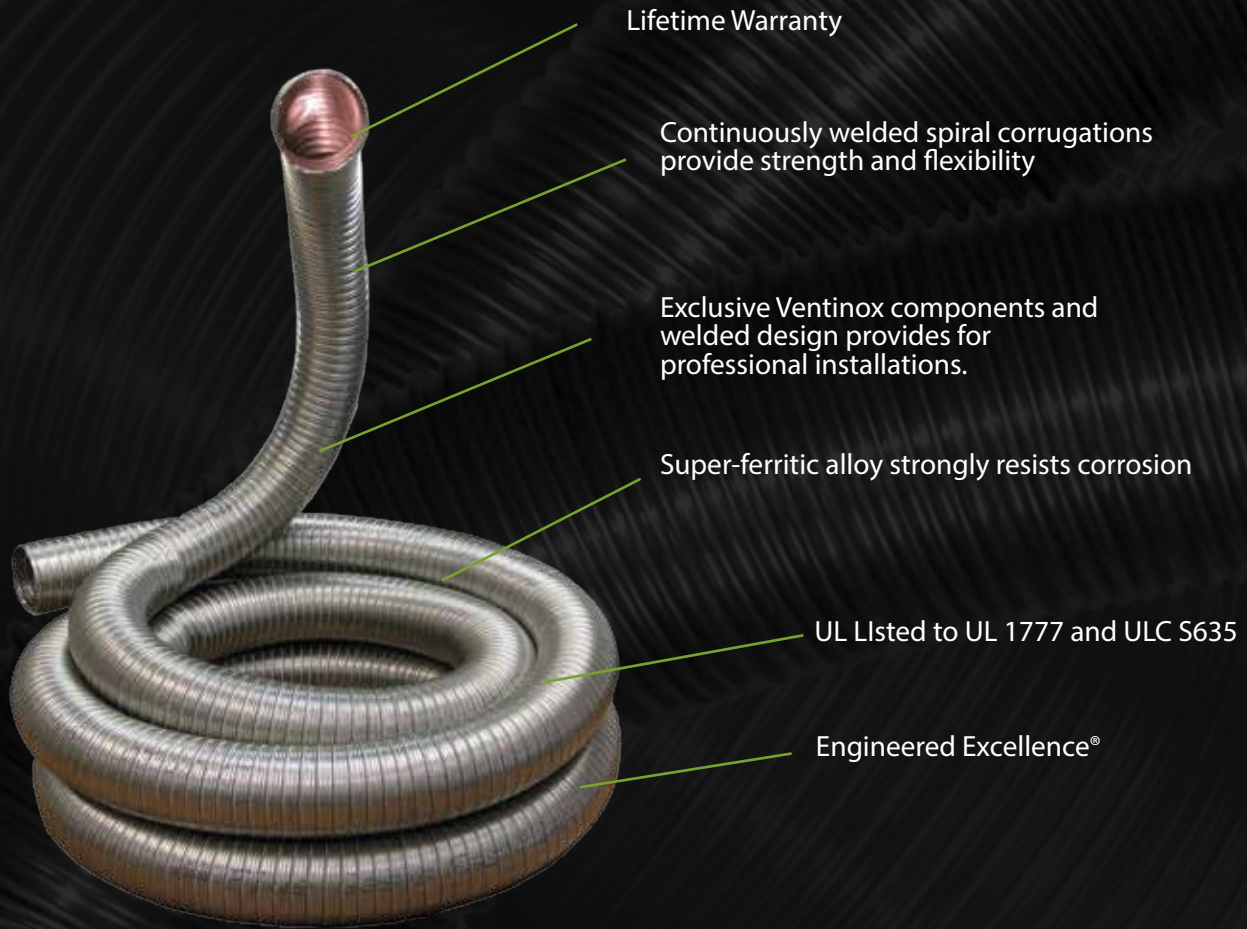

Ventinox Feature	Benefit	Ventinox Feature	Benefit	Ventinox Feature	Benefit
Lifetime Warranty	The best Warranty in the industry. DuraVent provides 100% warranty for the lifetime of the product. Gives the installer and homeowner the greatest peace of mind in a quality installation.	316Ti Stainless Steel	Ventinox VFT can withstand high temperatures, the corrosive elements and sulfuric acid exposure. Exhibits good pitting resistance.	0" Clearance	VFT has a 0" clearance to masonry chimney for oil and gas, and with Thermix or ProFoil insulation, 0" clearance for solid fuels. VG has a 0" clearance to masonry for gas appliances.
Welded Spiral Corrugations	Continuously welded spiral corrugations renders Ventinox air and water tight while providing superior strength and excellent flexibility. Welded design eliminates adding a silicone seal in the field at the seams.	AL29-4C	Ventinox VG can withstand highly corrosive condensates and exhibits extreme resistance to chloride pitting, crevice corrosion, stress corrosion and cracking.	Heat absorption	Steel is known to expand when exposed to heat. Ventinox absorbs any expansion in its corrugations and does not twist or grow in length.
Lightweight	The continuously welded stainless steel strip acts as a backbone and produces a lightweight liner 20% stronger than its competitors, resisting crushing and tearing.	Integral locking band	Components feature an integral locking band, avoiding the use of pop rivets and the need for pre-drilling liners.	U.S. made since 1979	Proven to be safe and effective in thousands of American homes since 1979 and recognized and approved by home-heating experts and building code officials.
				VFT Extensions	Use as an economical solution to add a few extra feet when needed to complete a run.