



6,000 BTU/H CEILING MOUNTED IDU

SUBMITTAL COVER SHEET

PROJECT NAME _____

LOCATION _____

ARCHITECT _____

ENGINEER _____

CONTRACTOR _____

REFERENCE _____

SUBMITTED BY _____ DATE _____

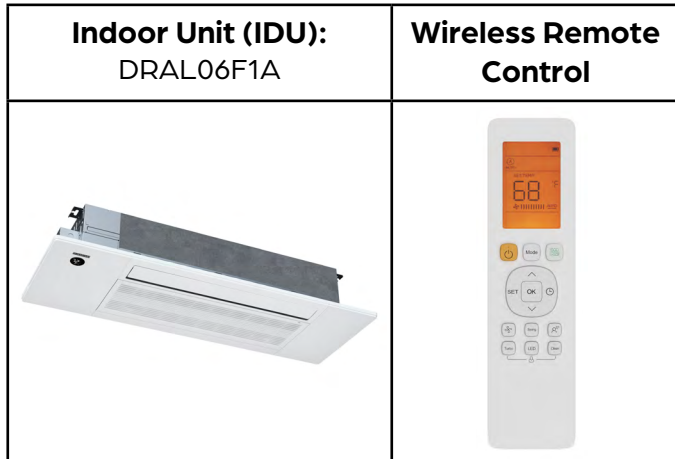

PRODUCT FEATURES

- Single or multi-zone compatible
- Wireless Remote Control with "Follow Me" Technology
- Slim design for easy install between 16" joists
- Serviceable from below
- Washable filter
- Humidity sensor
- Built in drain pump
- Sleep Mode
- Turbo Mode
- 24-Hour Timer Feature
- Quiet operation as low as 32.5 dB
- High efficiency up to 22 SEER2

SPECIFICATIONS		
Cooling Capacity (BTU/hr)	6500	
Heating Capacity (BTU/hr)	7100	
Voltage/Phase/Frequency	208-230V, 1 Phase, 60 Hz	
Voltage Range	187-253V	
Indoor Unit Air Flow (CFM)	Low	235
	Medium	259
	High	294
Drain Port O.D.	1"	
Drain Port Lift	20.8	
Recommended Breaker (Amps)	15	
Sound Pressure (dB(A))	Low	32.5
	Medium	35.5
	High	37.5
Refrigerant	R410A	

LINE SET REQUIREMENTS	
Connection Type	Flare
Liquid	Ø1/4" (Ø6.35mm)
Gas	Ø3/8" (Ø9.52mm)

DIMENSIONS AND WEIGHT		
Unit Dimensions	Width	50-5/16"
	Depth	13-3/16"
	Height	9"
Carton Dimensions	Width	57-5/8"
	Depth	22-1/2"
	Height	22-1/2"
Net Weight	58.4 lbs.	
Gross Weight	81.3 lbs.	





6,000 BTU/H CEILING MOUNTED IDU

IDU DIMENSIONS - DRAL06F1A

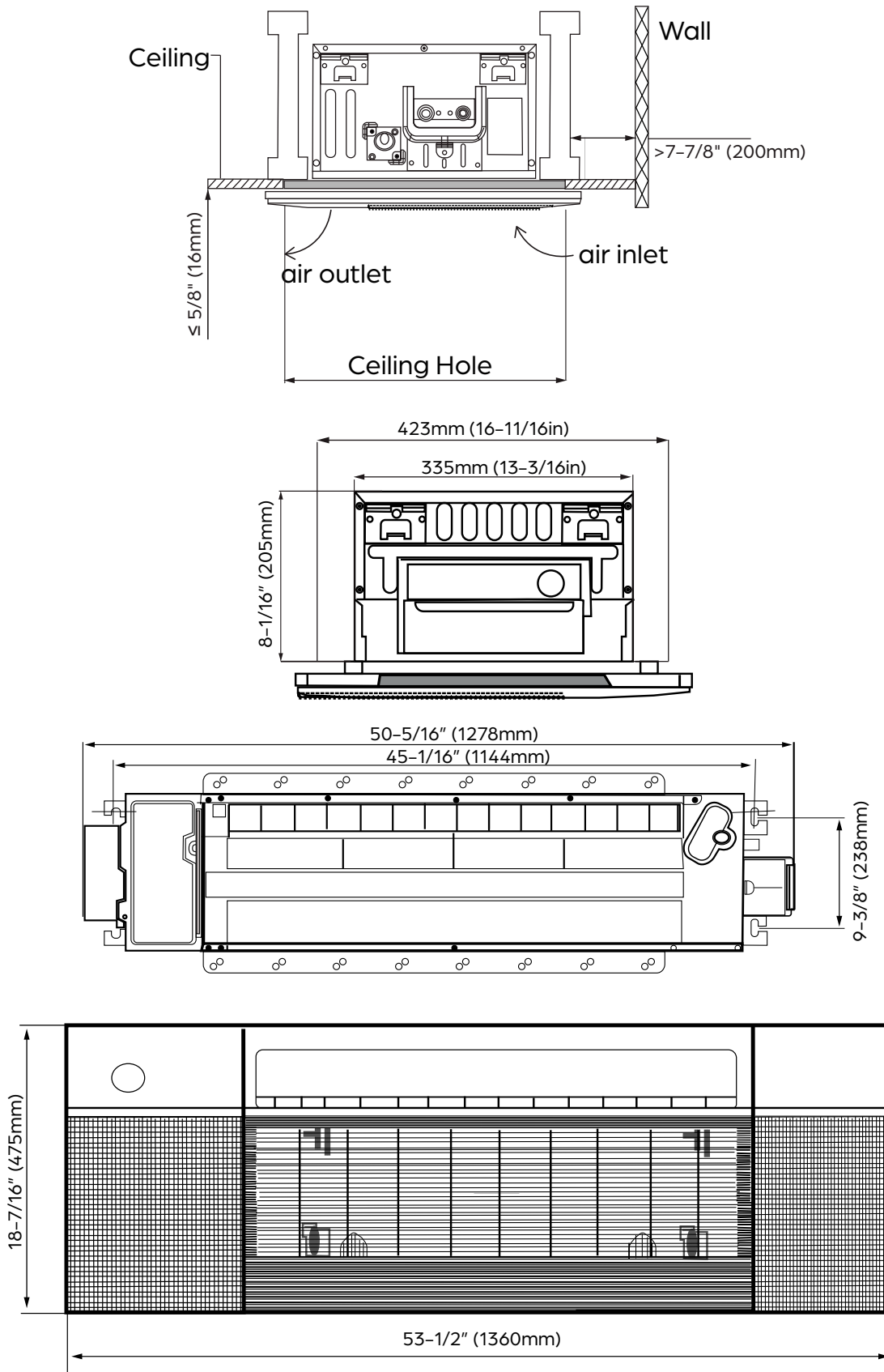



12,000 BTU/H WALL MOUNTED IDU

SUBMITTAL COVER SHEET

PROJECT NAME _____

LOCATION _____



ARCHITECT _____

ENGINEER _____

CONTRACTOR _____

REFERENCE _____

SUBMITTED BY _____ DATE _____

Indoor Unit (IDU): DRAL12F1A	Wireless Remote Control
	

PRODUCT FEATURES

- Single or multi-zone compatible
- Wireless Remote Control with "Follow Me" Technology
- Slim design for easy install between 16" joists
- Serviceable from below
- Washable filter
- Humidity sensor
- Built in drain pump
- Sleep Mode
- Turbo Mode
- 24-Hour Timer Feature
- Quiet operation as low as 32.5 dB
- High efficiency up to 23 SEER2

SPECIFICATIONS		
Cooling Capacity (BTU/hr)	12000	
Heating Capacity (BTU/hr)	12500	
Voltage/Phase/Frequency	208-230V, 1 Phase, 60 Hz	
Voltage Range	187-253V	
Indoor Unit Air Flow (CFM)	Low	247
	Medium	282
	High	312
Drain Port O.D.	1"	
Drain Port Lift	20.8	
Recommended Breaker (Amps)	15	
Sound Pressure (dB(A))	Low	34.5
	Medium	38.5
	High	40.5
Refrigerant	R410A	

LINE SET REQUIREMENTS	
Connection Type	Flare
Liquid	Ø1/4" (Ø12.70mm)
Gas	Ø1/2" (Ø9.52mm)

DIMENSIONS AND WEIGHT		
Unit Dimensions	Width	50-5/16"
	Depth	13-3/16"
	Height	9"
Carton Dimensions	Width	57-5/8"
	Depth	22-1/2"
	Height	22-1/2"
Net Weight	60.7 lbs.	
Gross Weight	82.9 lbs.	





12,000 BTU/H WALL MOUNTED IDU

IDU DIMENSIONS - DRAL12F1A

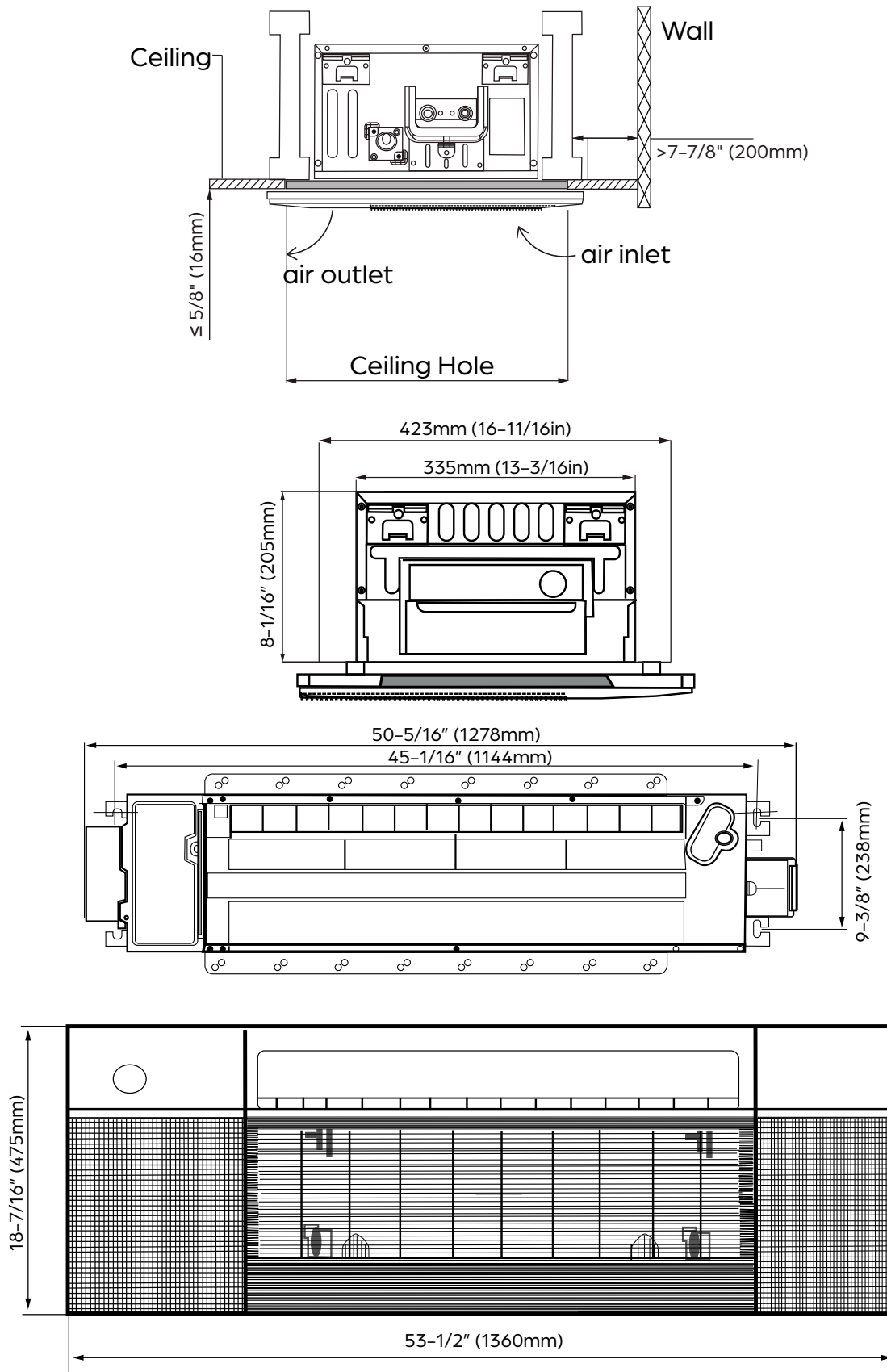



18,000 BTU/H WALL MOUNTED IDU

SUBMITTAL COVER SHEET

PROJECT NAME _____

LOCATION _____

ARCHITECT _____

ENGINEER _____

CONTRACTOR _____

REFERENCE _____

SUBMITTED BY _____ DATE _____

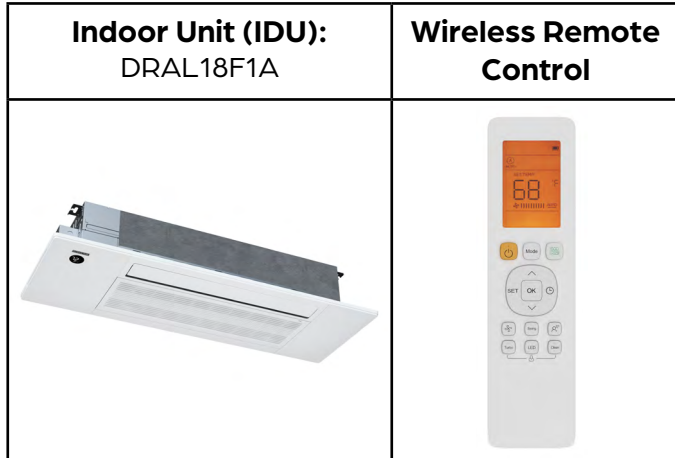

PRODUCT FEATURES

- Single or multi-zone compatible
- Wireless Remote Control with "Follow Me" Technology
- Slim design for easy install between 16" joists
- Serviceable from below
- Washable filter
- Humidity sensor
- Built in drain pump
- Sleep Mode
- Turbo Mode
- 24-Hour Timer Feature
- Quiet operation as low as 35 dB
- High efficiency up to 21 SEER2

SPECIFICATIONS		
Cooling Capacity (BTU/hr)	18000	
Heating Capacity (BTU/hr)	19000	
Voltage/Phase/Frequency	208-230V, 1 Phase, 60 Hz	
Voltage Range	187-253V	
Indoor Unit Air Flow (CFM)	Low	207
	Medium	300
	High	352
Drain Port O.D.	1"	
Drain Port Lift	20.8	
Recommended Breaker (Amps)	15	
Sound Pressure (dB(A))	Low	34
	Medium	41
	High	44
Refrigerant	R410A	

LINE SET REQUIREMENTS	
Connection Type	Flare
Liquid	Ø1/4" (Ø6.35mm)
Gas	Ø1/2" (Ø12.7mm)

DIMENSIONS AND WEIGHT		
Unit Dimensions	Width	50-5/16"
	Depth	13-3/16"
	Height	9"
Carton Dimensions	Width	57-5/8"
	Depth	22-1/2"
	Height	22-1/2"
Net Weight	60.7 lbs.	
Gross Weight	82.9 lbs.	





18,000 BTU/H WALL MOUNTED IDU

IDU DIMENSIONS - DRAL18F1A

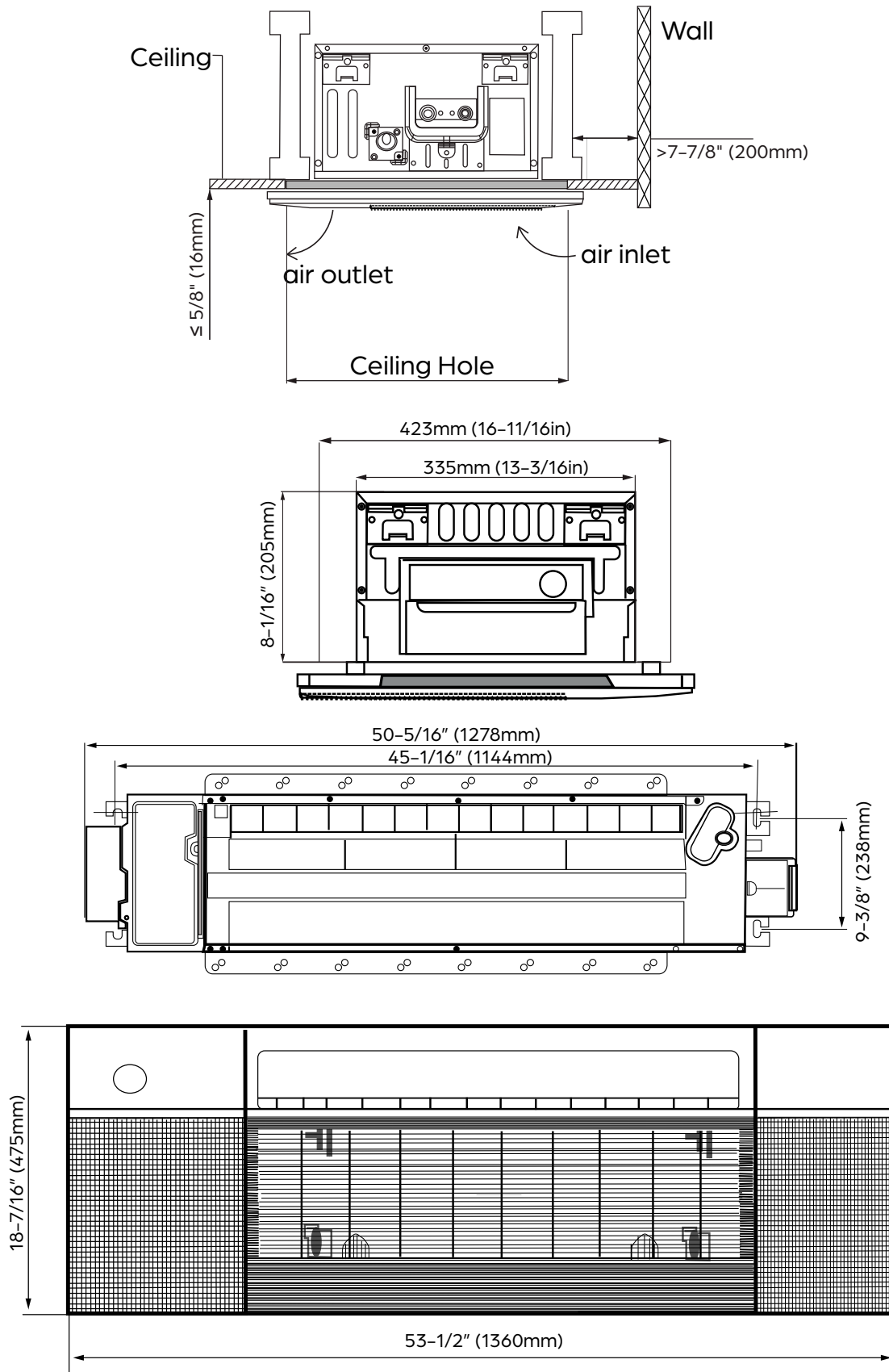



SIRIUS HEAT™

48,000 BTU/H SIRIUS HEAT MULTI-ZONE HEAT PUMP

SUBMITTAL COVER SHEET

PROJECT NAME _____

LOCATION _____

ARCHITECT _____

ENGINEER _____

CONTRACTOR _____

REFERENCE _____

SUBMITTED BY _____ DATE _____

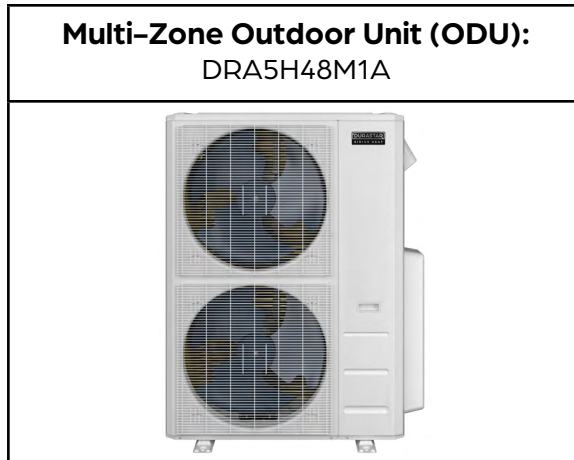

PRODUCT FEATURES

- High heating capacity at 0°F
- Variable speed inverter compressor
- Low ambient heating down to -22°F
- Low ambient cooling down to 5°F
- Quiet operation
- Included base pan heater
- Auto restart
- Anti-corrosive coil coating
- Port adaptors included

SYSTEM DATA	
Refrigerant Type	R-410A
Refrigerant Charge (oz.)	162
Design Pressure (PSIG)	550/340
Outdoor Coil Coating	Golden Fin Coating

CAPACITIES		DUCTLESS	MIXED	DUCTED
Cooling (BTU/hr)	Rated ¹	48000	48000	48000
	at 5°F ³	34920	34025	33130
	Minimum	12700	15600	18500
	Maximum	48400	49700	51000
Heating (BTU/hr)	Rated ²	49000	49500	50000
	at 5°F ⁴	45000	43750	42500
	Minimum	24500	18250	12000
	Maximum	61900	60450	59000
Nominal ODU Capacity ⁵		48000		

EFFICIENCY DATA	DUCTLESS	MIXED	DUCTED
SEER2	21.20	21.05	20.90
EER2	11.00	11.35	11.70
HSPF2	10.00	9.45	8.90
SEER	21.00	20.60	20.20
EER	11.00	11.20	11.40
HSPF	11.50	11.00	10.50
COP at 47°F	3.40	3.63	3.86
COP at 5°F	2.00	2.00	2.00



Specifications are subject to change without notice.
 © 2023 Ferguson Enterprises LLC
 www.durastar.com



48,000 BTU/H SIRIUS HEAT MULTI-ZONE HEAT PUMP

SPECIFICATIONS - DRA5H48M1A

SIRIUS HEAT™

LINE SET REQUIREMENTS	
Connection Type	Flare
Liquid	5 x Ø1/4" (Ø6.35mm)
Gas	3 x Ø3/8" (Ø9.52mm) 2 x Ø1/2" (Ø12.7mm)
Refrigeration Adaptors Included	3 x 3/8" -- 1/2" 2 x 1/2" -- 3/8" 2 x 1/4" -- 3/8" 2 x 1/2" -- 5/8"
Minimum Indoor Units Connected	2
Pre-Charge Length	123'
Maximum Length (combined IDUs)	262'
Maximum Length (per IDU)	115'
Minimum Length (per IDU)	10'
Max. Height Differential between IDU and ODU	49'
Max. Height Differential between IDUs	33'
Additional Refrigerant for Ø1/4" Liquid Pipe (oz./ft)	0.161
Additional Refrigerant for Ø3/8" Liquid Pipe (oz./ft)	0.322

ELECTRICAL DATA	DUCTLESS	DUCTED
Voltage/Phase/Frequency	208-230V, 1 Phase, 60 Hz	
Voltage Range	187-253V	
Recommended Breaker (Amps)	60	
Minimum Circuit Ampacity (Amps)	40	
Communication Wire Size	14*4 AWG Stranded	
Rated Current - Cooling (Amps) ¹	20.0	18.2
Rated Current - Heating (Amps) ²	19.1	17.2

¹ AHRI Rated at 95°F (AFull).

² AHRI Rated at 47°F (H1Full).

³ Sensible Capacity: Indoor 80°F DB, 67°F WB // Outdoor 5°F DB, 4°F WB

⁴ AHRI Rated Capacity at 5°F (H42)

⁵ If the total indoor unit load exceeds the nominal capacity of the outdoor unit, the practical output capacity of each indoor unit will be correspondingly reduced. This situation is very evident during heating mode.

OUTDOOR UNIT DATA		
Unit Dimensions	Width	37-1/2"
	Depth	16-5/16"
	Height	52-1/2"
Carton Dimensions	Width	43-1/8"
	Depth	19-1/2"
	Height	58-1/4"
Net Weight	238 lbs.	
Gross Weight	270 lbs.	
Cooling Operating Temperature	5°F - 122°F	
Heating Operating Temperature	-22°F - 75°F	
Airflow (CFM)	4500	
Sound Pressure (dB(A))	65	
Fan Speed (r/min)	Low	750
	Medium	800
	Medium	850
	High	900
Fan Motor Current Type	DC	

COMPRESSOR	
Type	DC Inverter Twin Cylinder Rotary
Oil Type	VG74
Oil Charge (oz.)	49 (1460mL)

Clearances

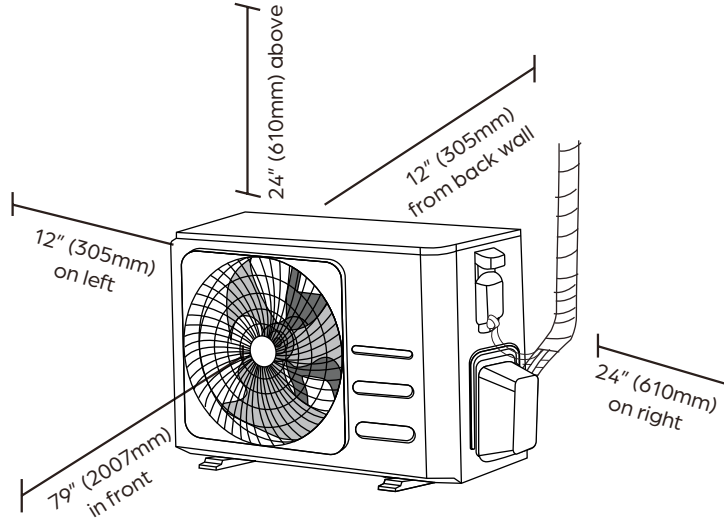

Dimensions

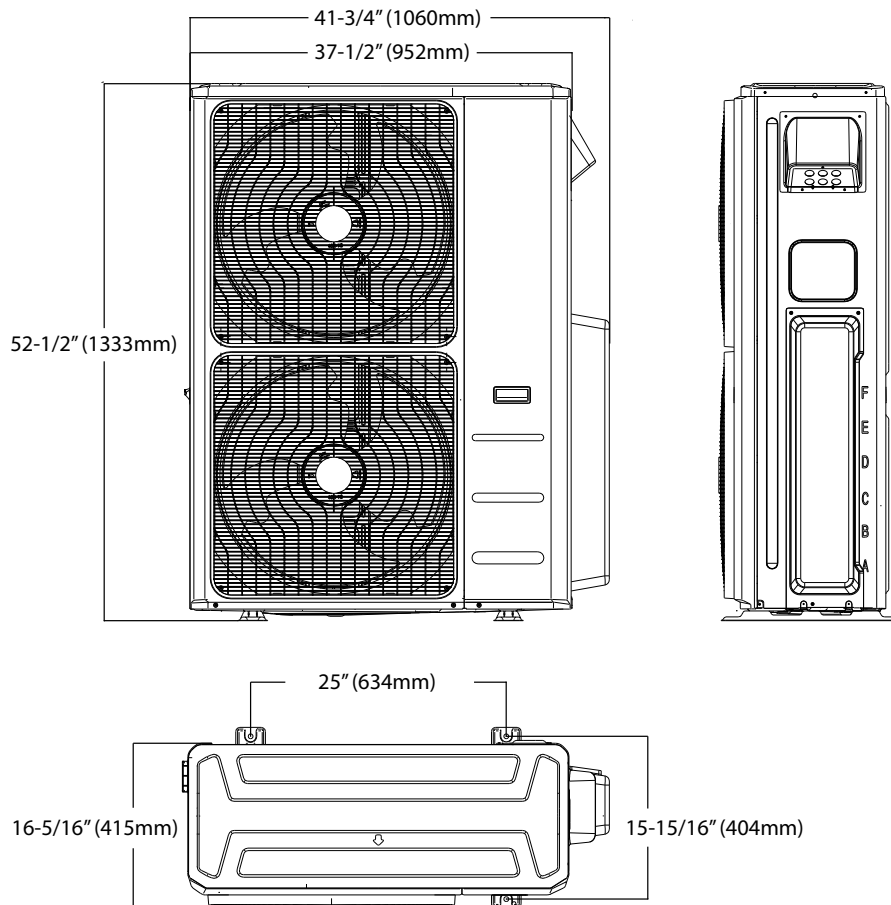

NOTE

- Illustrations in this document are for explanatory purposes. The actual shape of your mini-split equipment may vary slightly.