

OWNER'S MANUAL

**WALL MOUNTED INDOOR UNIT  
SPLIT-STYLE AIR CONDITIONER**

DRAW06F1B, DRAW09F1B, DRAW12F1B,  
DRAW18F1B, DRAW24F1B

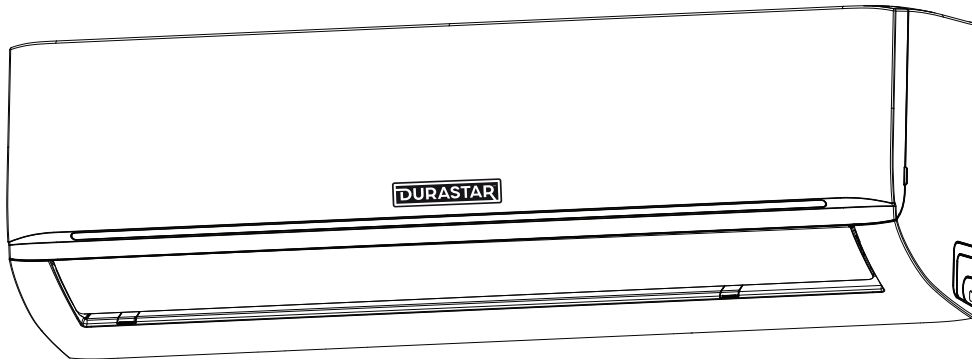

Model Number:

Serial Number:

Purchase Date:

Installing Contractor Company Name:



**TIP**

Capture relevant information about your Durastar mini-split equipment before it is installed and write it above for future reference.

## TABLE OF CONTENTS

TABLE OF CONTENTS .....	2
INTRODUCTION .....	3
WARNINGS .....	3
IMPORTANT SAFETY PRECAUTIONS.....	4
PARTS IDENTIFICATION .....	7
INCLUDED ACCESSORIES .....	8
OPERATING TEMPERATURES.....	9
REMOTE CONTROL.....	10
REMOTE CONTROL SCREEN INDICATORS .....	11
OPERATING MODES .....	12
ADVANCED BUTTONS AND FEATURES .....	13
LOUVERED AIR FLOW .....	17
LED DISPLAY INDICATORS.....	18
MANUAL OPERATION (USE WITHOUT REMOTE) .....	18
CARE AND MAINTENANCE .....	19
TROUBLESHOOTING.....	21
LIMITED WARRANTY - PARTS.....	26

## INTRODUCTION

To better serve you, please do the following before contacting customer service:

- If you received a damaged product, immediately contact the retailer or dealer that sold you the product.
- Read and follow this owner's manual carefully to help you use and maintain your air conditioner.
- Read the troubleshooting section of this manual as it will help you diagnose and solve common issues.
- Visit us on the web at [www.durastar.com](http://www.durastar.com) to download product guides and up-to-date information.
- If you need warranty service, our friendly customer service representatives are available via email at [questions@durastar.com](mailto:questions@durastar.com) or by telephone at 1-888-320-0706.

## WARNINGS

### Symbols Used in This Manual



The warning symbol indicates cautionary information for the user. Extra care and precautions should be taken to ensure the user's safety.



The pencil indicates any manufacturer notes relating to surrounding content. These may include further clarifications or call-outs.



A light bulb symbol indicates suggested manufacturer tips for the user to get the most out of the Durastar equipment and to accommodate the best user experience.

## IMPORTANT SAFETY PRECAUTIONS

Improper handling can cause serious damage or injury. Please read the following safety information in its entirety.



### **Operation, Cleaning, and Maintenance Safety Precautions**

- Children and people with reduced physical, sensory, or mental capabilities, or lack of experience and knowledge, should only use this air conditioner if they are given supervision or instructions concerning use of the air conditioner in a safe way and understand the hazards involved.
- Children should not play with the air conditioner.
- Never stick fingers or any other body parts into the air conditioner openings. The internal fan may be rotating at high speeds, and may result in injury.
- After removing the filter, do not touch the fins in order to avoid injury.
- Maintenance must be performed by qualified professionals. Otherwise, you may experience personal injury or damage to the air conditioner and surrounding property.
- Do not repair the air conditioner by yourself. It may cause electric shock or damage. Please contact a qualified service representative when you need to repair the air conditioner.
- Do not block the air outlet or air inlet. This could cause a malfunction.
- Do not spill water on the remote control as this can permanently damage the remote.
- If the below problems occur, please turn off the air conditioner and disconnect power at the circuit breaker immediately. Then contact your dealer or a qualified professional for service.
  - The power cord is overheating or damaged.
  - There is an abnormal sound during operation.
  - The circuit breaker trips frequently.
  - The air conditioner gives off a burning smell.
  - The indoor unit is leaking.
- If the air conditioner operates under abnormal conditions, it may cause malfunctions, electric shock, or fire hazard.
- When turning the unit on or off via the emergency operation switch, press the switch with an insulated object other than metal.
- Do not step on the top panel of the unit, or put heavy objects on the top panel. This could cause damage or personal injury.
- Cleaning and user maintenance should not be performed by children without supervision.
- Do not spray water on the indoor unit. This could cause electric shock or a unit malfunction.
- Do not use flammable materials such as hair spray, lacquer, or paint near the air conditioner as they may catch fire.
- Do not operate the air conditioner in places near combustible gases. Emitted gases may collect around the air conditioner and cause an explosion.
- Do not use fire or a hair dryer to dry the filter. This could cause a deformation or fire hazard.
- Do not wash the air conditioner with water as this could cause an electric shock.
- Disconnect the power supply by turning it off at the circuit breaker when cleaning the air conditioner. Otherwise, you could risk electric shock.

**Electrical Safety**

- Do not modify the length of the power supply cord or use an extension cord to power the unit.
- If the supply cord is damaged, it must be replaced by the manufacturer, a service agent, or a similarly qualified person in order to avoid a safety hazard.
- Do not share the electrical outlet with other appliances. Improper or insufficient power supply can cause fire or electrical shock.
- The product must be properly grounded at the time of installation, or electrical shock may occur.
- For all electrical work, follow all local and national wiring standards and regulations. Connect cables tightly, and clamp them securely to prevent external forces from damaging the terminal. Improper electrical connections can overheat and cause fire, and may also cause shock. All electrical connections must be made according to the Electrical Connection Diagram located on the panels of the indoor and outdoor units.
- All wiring must be properly arranged to ensure that the control board cover can close properly. If the control board cover is not closed properly, it can lead to corrosion and cause the connection points on the terminal to heat up, catch fire, or cause electrical shock.
- The air conditioner's circuit board (PCB) is designed with a fuse to provide overcurrent protection. The specifications of the fuse are printed on the circuit board.



### **Installation Safety**

- Installation must be performed by an authorized dealer or specialist. Improper installation can cause water leakage, electrical shock, or fire. (In North America, installation must be performed in accordance with NEC and CEC requirements by authorized personnel only.)
- Installation must be performed according to the installation instructions. Improper installation can cause water leakage, electrical shock, or fire.
- This air conditioner shall be installed in accordance with national and local wiring regulations.
- Contact an authorized service technician for repair or maintenance of this unit.
- Only use the included accessories, parts, and specified parts for installation. Using non-standard parts can cause water leakage, electrical shock, fire, and can cause the unit to fail.
- Install the unit in a firm location that can support the unit's weight. If the chosen location cannot support the unit's weight, or the installation is not done properly, the unit may fall and cause serious injury and damage.
- Install drainage piping according to the instructions in the installation manual. Improper drainage may cause water damage to your home and property.
- Do not install the unit in a location that may be exposed to combustible gas leaks. If combustible gas accumulates around the unit, it may cause a fire.
- Do not turn on the power until all work has been completed.
- When moving or relocating the air conditioner, consult experienced service technicians for disconnection and re-installation of the unit.



### **Additional Precautions**

- Turn off the air conditioner and disconnect the power if you are not going to use it for a long time.
- Turn off the unit during electrical storms to avoid damaging the unit.
- Make sure that water condensation can drain unhindered from the unit.
- Do not operate the air conditioner with wet hands. This may cause electric shock.
- Do not use this device for any other purpose than its intended use.
- Do not climb onto or place objects on top of the outdoor unit.
- Do not allow the air conditioner to operate for long periods of time with doors or windows open, or if the humidity is very high.

# PARTS IDENTIFICATION

## INDOOR UNIT

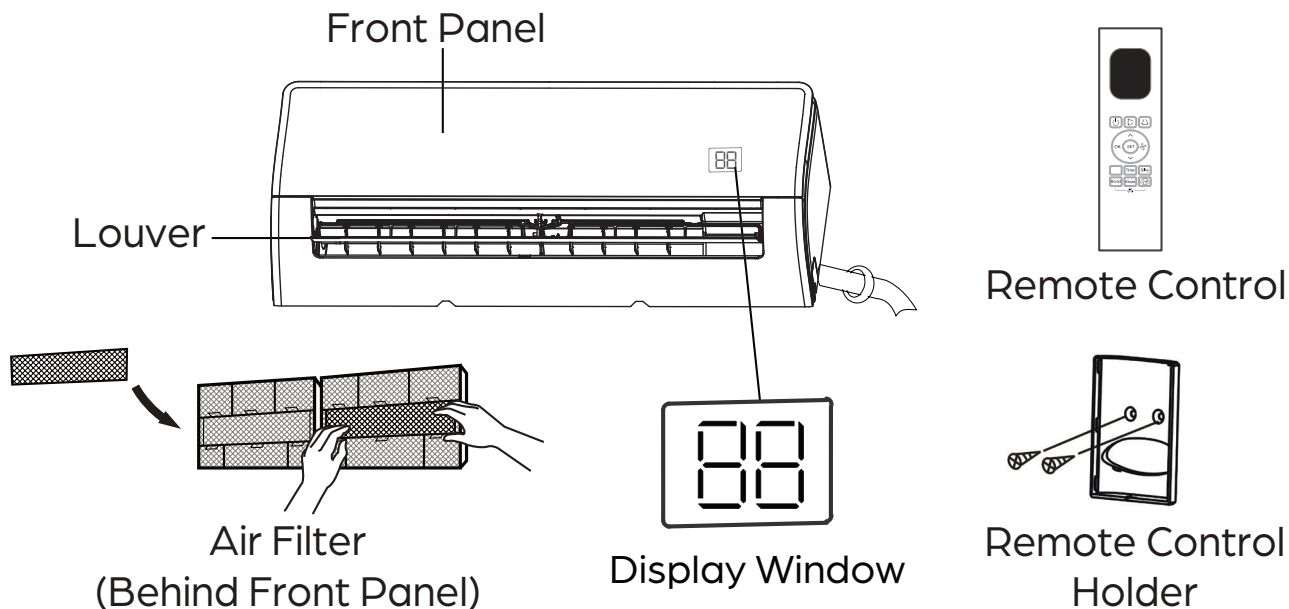

## OUTDOOR UNIT

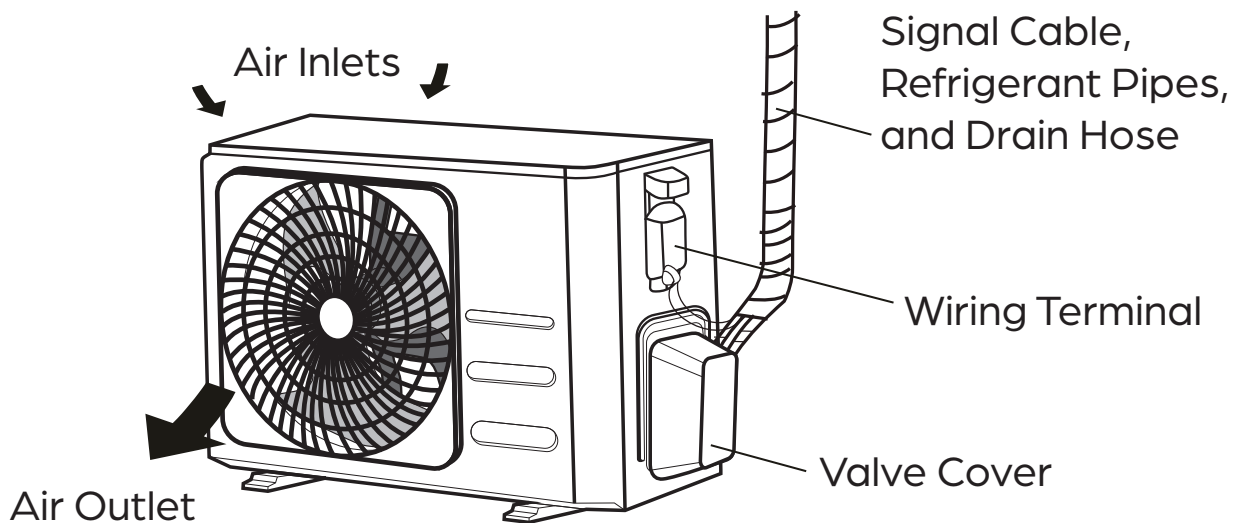









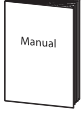

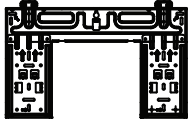
**NOTE**

Outdoor units will vary in appearance.

## INCLUDED ACCESSORIES

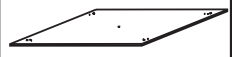
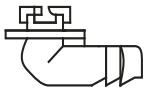
The air conditioning system comes with the following accessories.

Accessory	Quantity	Image	Accessory	Quantity	Image
Manual	1-2		Remote Control	1	
Mounting Plate	1		Battery	2	
Wall Anchor	5-8 (depending on model)		Remote Control Holder	1	
Mounting Plate Screw	5-8 (depending on model)		Remote Control Holder Mounting Screw	2	
Copper Nut	2		Installation Template	1	
Drain Joint	1		Carbon Filter	2	
Drain Joint Seal	1				



## OPERATING TEMPERATURES

Your air conditioner is designed to operate in the following indoor and outdoor temperatures. When your air conditioner is used outside of the following temperature ranges, certain safety features may activate and turn off the unit to protect it from damage.

### TEMPERATURE RANGES

	<b>COOL Mode</b>	<b>HEAT Mode</b>	<b>DRY Mode</b>
<b>Indoor Air Temperature</b>	60°F – 90°F (16°C – 32°C)	32°F – 86°F (0°C – 30°C)	50°F – 90°F (10°C – 32°C)
<b>Outdoor Air Temperature</b>	5°F – 122°F (–15°C – 50°C)	–13°F – 75°F* (–25°C – 24°C)*	32°F – 122°F (0°C – 50°C)

\* The minimum operating temperature depends on the outdoor unit. Low ambient models have a minimum operating temperature in heat mode of –22°F (–30°C).

To further optimize the performance of your unit, do the following:

- Keep doors and windows closed.
- Limit energy usage by using TIMER ON and TIMER OFF features.
- Do not block air inlets or outlets.
- Regularly inspect and clean air filters.

#### NOTE



Your Durastar heat pump's outdoor unit is equipped with a base pan heater, allowing it to continue to operate at freezing temperatures as low as –22°F (–30°C). When outdoor air temperatures are at or below 32°F (0°C), we strongly recommend keeping the unit plugged in at all times to ensure smooth, ongoing performance.

#### NOTE



Keep the room's relative humidity below 80%. If the air conditioner operates in excess of this, the surface of the air conditioner may attract condensation. To help prevent condensation from forming and dripping, set the vertical airflow louver to its maximum angle (vertically to the floor) and set the fan to HIGH.

## REMOTE CONTROL

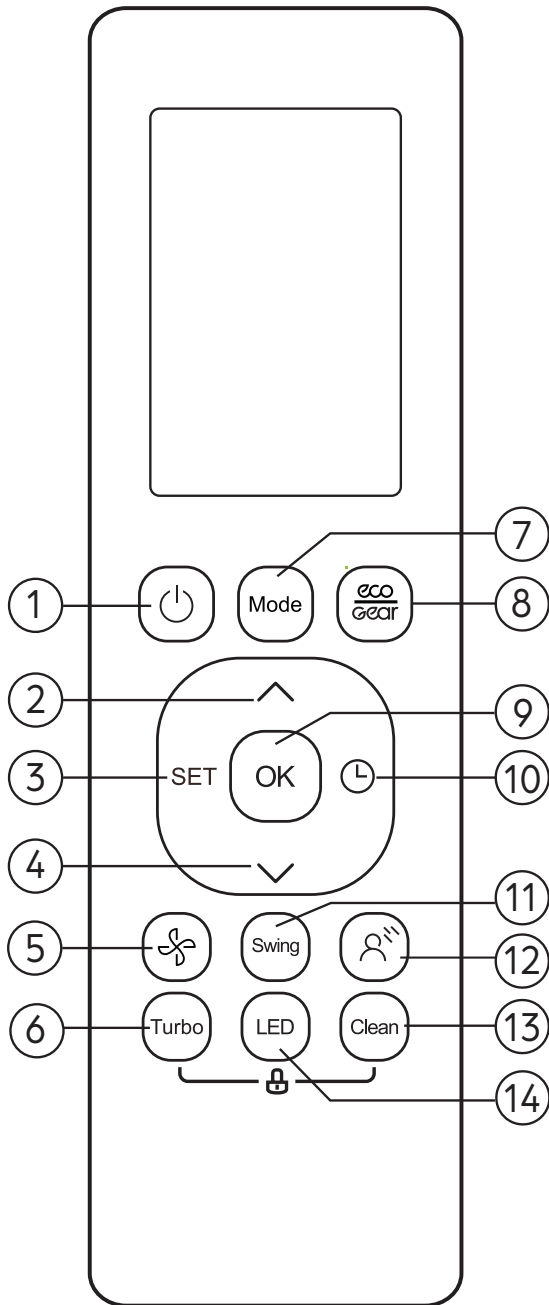

**1. ON/OFF Button**

Turns the air conditioner ON and OFF.

**2. UP Button (▲)**

Press to increase the set temperature in 1°F / 1°C increments .

**3. SET Button**

Press to access the SET features menu. See "Advanced Buttons and Features" section.

**4. DOWN Button (▼)**

Press to decrease the set temperature in 1°F / 1°C increments. Press (▲) and (▼) at the same time for 3 seconds to switch between °F and °C.

**5. FAN Button**

Press to select FAN speed.

**6. TURBO Button**

Press to turn on and off the TURBO feature. See "Advanced Buttons and Features" section.

**7. MODE Button**

Press to adjust the air conditioner MODE in the following sequence: AUTO → COOL → DRY → HEAT → FAN

**8. ECO/GEAR Button**

Press to enter one of three energy efficiency modes. See "Advanced Buttons and Features" section.

**9. OK Button**

Press to confirm selected functions.

**10. TIMER Button**

Press to initiate the TIMER feature. See "Advanced Buttons and Features" section.

**11. SWING Button**

Press to start and stop the automatic horizontal louver movement or set a fixed louver angle.

**12. GENTLE Button**

Press to stop the air flow from blowing directly on you if it becomes uncomfortable. See "Advanced Buttons and Features" section.

**13. CLEAN Button**

Turns on and off the CLEAN feature. See "Advanced Buttons and Features" section.

**14. LED Button**

Press to turn on and off the indoor unit's display screen.

# REMOTE CONTROL SCREEN INDICATORS

## Transmission Indicator

Lights up when remote sends signal to indoor unit.



**TIMER ON** display



**TIMER OFF** display



**SILENCE** feature display

## FAN SPEED display

Displays selected fan speed:

Silence		1%
		2%-20%
LOW		21%-40%
MED		41%-60%
		61%-80%
HIGH		81%-100%
AUTO		

The fan speed cannot be adjusted in AUTO or DRY mode.

Note:

Not all the models can display the fan speed values between AUTO-100%.

- GENTLE** feature display
- CLEAN** feature display
- SLEEP** feature display
- FOLLOW ME** feature display
- Network display (not available for this unit)
- Low battery display (If flashing)

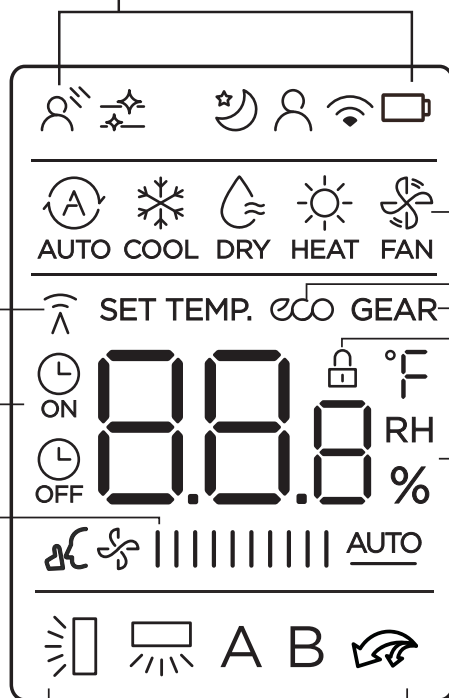

## MODE display

Displays the current mode, including:



## ECO display

Displays when ECO feature is activated.

## GEAR display

Displays when GEAR feature is activated.

## LOCK display

Displays when LOCK feature is activated.

Temperature/Timer/  
Fan Speed % display  
Displays the set temperature unless the fan speed or timer setting functions are in use.

## TIMER ON/OFF functions.

- Temperature range: 60-86°F (16-30°C)
- Timer setting range: 0-24 hours
- Fan speed setting range: AUTO -100%

This display is blank when operating in **FAN** mode.

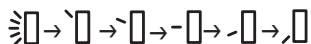

**Horizontal** louver swing display



**Vertical** louver swing (not available on unit)



**TURBO** feature display



A Not available for this unit



B Not available for this unit





## NOTE

All indicators shown in the above figure are for purposes of clear representation. During actual operation, only the relative indicators are illuminated in the display window.

## OPERATING MODES ( )

### SETTING TEMPERATURE

This unit can be set at any temperature within its operating range in AUTO, COOL, HEAT, and DRY modes (see "Temperature Ranges" section). You can increase or decrease the set temperature in 1°F (1°C) increments by pressing the UP (  ) or DOWN (  ) button.

### AUTO ( )

In AUTO mode, the unit will automatically select the COOL, FAN, HEAT, or DRY modes to maintain the set temperature. In AUTO mode, the fan speed cannot be set.

1. Select AUTO mode
2. Set desired temperature
3. Turn on air conditioner

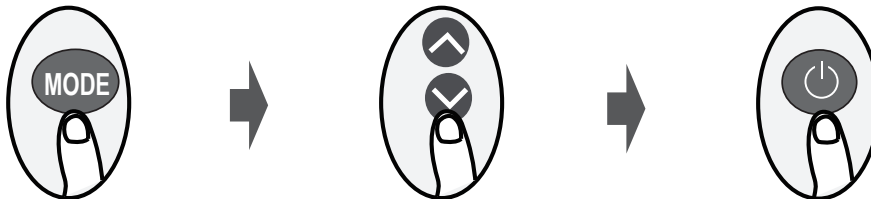

### COOL or HEAT ( or )

1. Select COOL or HEAT mode
2. Set desired temperature
3. Set fan speed
4. Turn on air conditioner

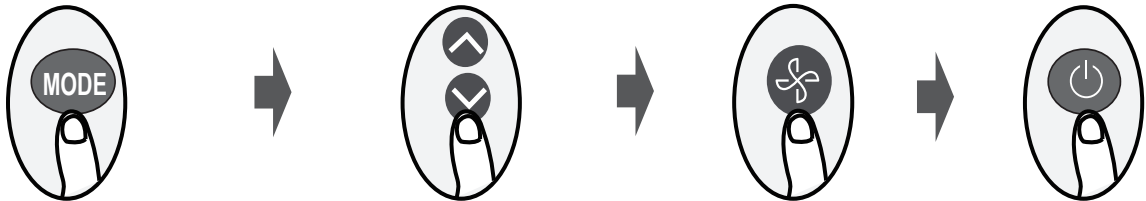

### DRY/DEHUMIDIFY ( )

In DRY mode, the fan runs continuously on low speed. The unit will operate continuously until it reaches 50°F (10°C), at which time it will turn off. DRY mode operation will then resume once the room temperature reaches 54°F (12°C).

1. Select DRY mode
2. Set any temperature
3. Turn on air conditioner

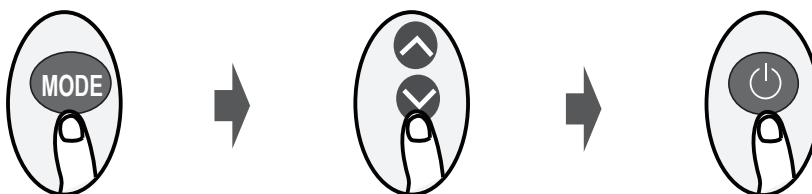

#### NOTE

\*For this series of mini-splits, changing the temperature in DRY mode does not deviate performance from the above mode description.



#### NOTE

The FAN speed cannot be adjusted in AUTO or DRY Mode.



#### NOTE

Press and hold the UP and DOWN buttons simultaneously for 3 seconds to switch between °F and °C.

## FAN ( )

In FAN mode, the temperature cannot be set and no temperature will be displayed on the remote screen.

1. Select FAN mode

2. Set fan speed

3. Turn on air conditioner



### NOTE

You cannot adjust the temperature in FAN mode. As a result, your remote control's LCD display will not display a temperature.



### NOTE

As outdoor temperature drops, the performance of your unit's HEAT function may be affected.



### NOTE

Two or more indoor units can be operated by one outdoor unit. However, two or more indoor units cannot operate simultaneously when different operating modes have been selected. If COOL/DRY/FAN is selected with one or more indoor units and HEAT with another, the unit(s) in HEAT has priority.

## ADVANCED BUTTONS AND FEATURES

### ECO/GEAR ( )

The ECO/GEAR feature provides three levels of energy saving options. ECO/GEAR is only available in COOL mode. Some of these options may result in insufficient cooling in circumstances of high ambient heat. The ECO/GEAR feature is not available in multiple zone configurations.

#### ECO ( *eco* )

While the unit is in COOL mode, press the ECO/GEAR button once. If the set temperature is above 75°F (24°C) the FAN speed will be set to AUTO. If the set temperature is below 75°F (24°C) it will automatically be adjusted to 75°F (24°C) and the FAN speed will be set to AUTO. When functioning in this mode, the unit can reduce its energy consumption up to 10%. Press the ECO/GEAR button to turn off this feature.

#### GEAR ( GEAR )

GEAR has two levels – 25% and 50% energy consumption. While the unit is in COOL mode, press the ECO/GEAR button twice (x2) within two (2) seconds to select 25% or three times (x3) to select 50%. If the set temperature is above 75°F (24°C) the FAN speed will be set to AUTO. If the set temperature is below 75°F (24°C) it will automatically be adjusted to 75°F (24°C) and the FAN speed will be set to AUTO. When functioning in these modes, the unit can reduce its energy consumption up to 25% or 50%. Press the ECO/GEAR button to turn off this feature.



### NOTE

The overall energy consumption of the unit is affected by many factors and this feature's energy reduction level setting will not result in directly proportional money savings on your energy bill.

## SET BUTTON FEATURES ( SET )

Press the SET button to open the feature menu at the top of the display. Next, press SET or UP (▲) and DOWN (▼) to highlight the desired feature's icon. Finally, press OK to activate it.

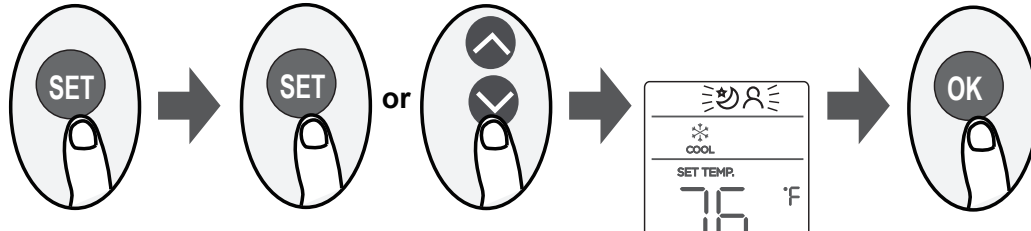

## SLEEP (☾)

The SLEEP feature is designed to decrease energy use while you sleep. The SLEEP feature is not available in FAN or DRY mode.

When you are ready to go to sleep, press the SET button, select the SLEEP icon and press OK. When in COOL mode, the unit will increase the temperature by 2°F (1°C) after one hour, and will increase an additional 2°F (1°C) after another hour. When in HEAT mode, the unit will decrease the temperature by 2°F (1°C) after one hour, and will decrease an additional 2°F (1°C) after another hour.

The SLEEP feature will turn off after eight hours and the system will return to normal functioning.

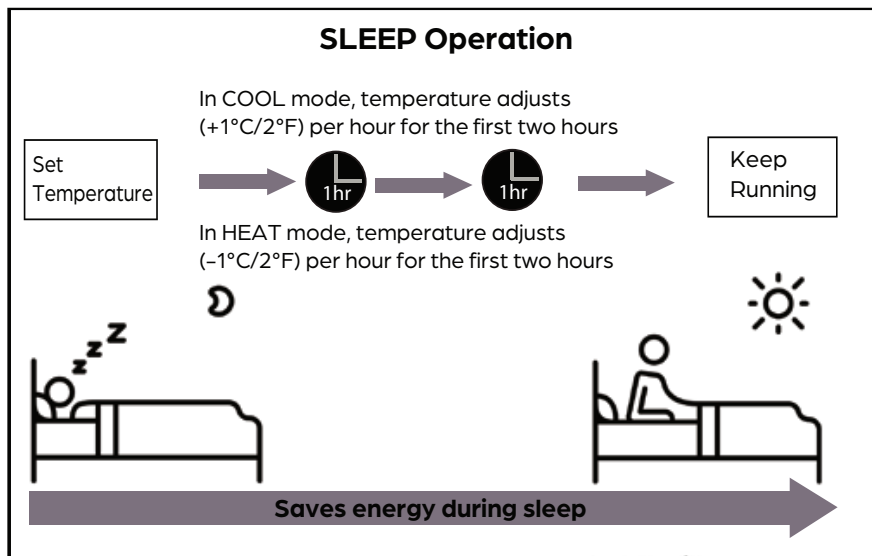

## FOLLOW ME (👤)

This feature uses the temperature at the remote's location, instead of the indoor unit's location, to optimize the temperature around you and ensure maximum comfort. To activate the FOLLOW ME feature, press the SET button, select the FOLLOW ME icon and press OK. To deactivate FOLLOW ME press ON/OFF or change the MODE.

To lock the FOLLOW ME feature, press and hold the TURBO button for seven (7) seconds. The remote will display "ON" for three (3) seconds and the temperature at its location. When using AUTO, COOL, and HEAT modes the air conditioner will continue running until the temperature at the remote's location is satisfied. Power failures, pressing ON/OFF or changing MODES will no longer cancel the feature. Press and hold the TURBO button again for seven (7) seconds to unlock and turn off this feature. The remote will display "OF" for three (3) seconds.

## NETWORK SETUP (📶)

This feature is not available on this unit.

**TIMER (🕒)**

The TIMER feature establishes the amount of time that will elapse before the unit will automatically turn on/off.

1. Press TIMER button to initiate the time ON sequence.
2. Press UP or DOWN button the required number of times to set the desired time to turn on the unit.
3. Point remote at unit for 1 second. The TIMER ON will be activated.

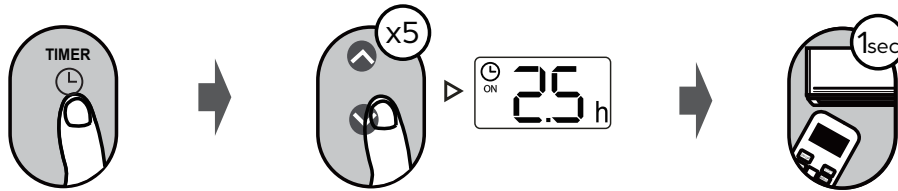

1. Press TIMER button to initiate the time OFF sequence.
2. Press UP or DOWN button the required number of times to set the desired time to turn on the unit.
3. Point remote at unit for 1 second. The TIMER OFF will be activated.

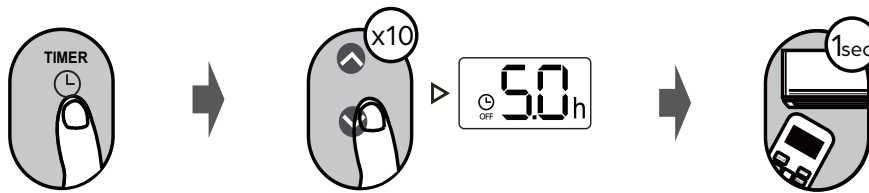

**TIMER ON and OFF setting example.**

Keep in mind that the time periods you set for both the on and off feature refers to hours after the current time.

If the current time is 1:00 PM and the TIMER ON setting is adjusted to 2.5 hours, the auto-on time sequence will turn the air conditioner on 2.5 hours later at 3:30 PM. Setting the TIMER OFF auto-off sequence to 5.0 hours will turn off the air conditioner 5 hours later at 6:00 PM.

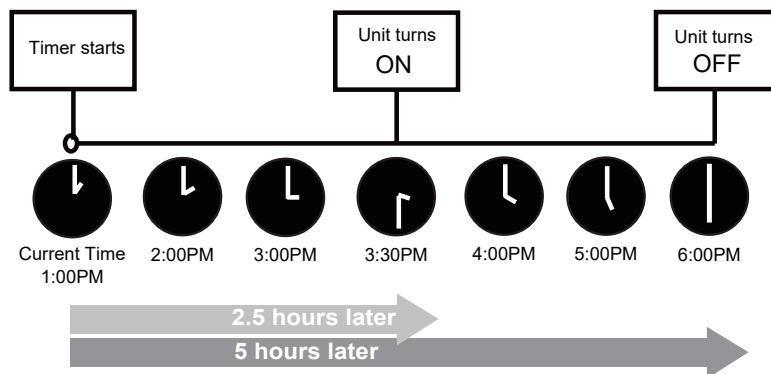

**GENTLE (🌀)**

If the air flow from the unit becomes uncomfortable because it is too intense or blowing directly on you, simply press the GENTLE button to slow the unit and divert the air flow away from you. Press the GENTLE button again to turn this feature off. This feature is only available under COOL, DRY, and FAN modes. This feature is not available in multiple zone configurations.

**TURBO** (  )

Press the TURBO button to turn this feature on and off. The TURBO feature enables the unit to reach the set temperature in the shortest time by automatically controlling the fan speed. This feature is only available in COOL and HEAT modes.

**LED** (  )

Press the LED button to turn on and off the display of the indoor unit.

**CLEAN** (  )

Airborne bacteria can grow in the moisture that condenses around the heat exchanger in the unit. With regular use, most of this moisture is evaporated from the unit. By pressing the CLEAN button, your unit will clean itself automatically. After cleaning, the unit will turn off automatically. Pressing the CLEAN button mid-cycle will cancel the operation and turn off the unit. You can use CLEAN as often as you like. You can only activate the CLEAN function in COOL or DRY modes. This feature is not available in multiple zone configurations.

**SILENCE** (  )

Press the FAN button for two (2) seconds to turn on and off the SILENCE feature. When the SILENCE feature is activated, the compressor will slow and the indoor unit will turn the fan to low. This will reduce the noise of the indoor unit to the lowest level. Due to the slow operation of the compressor, it may result in insufficient cooling and heating capacity. This feature is not available in multiple zone configurations.

**FREEZE PROTECTION (FP)**

The FREEZE PROTECTION feature sets the indoor temperature to 46°F (8°C). The unit will maintain this temperature and prevent indoor pipes and household items from freezing when the house is unoccupied for long periods of time in the winter. The display will show "FP" when this feature is on.

To activate, first turn the unit to HEAT mode and set the temperature to 60°F (16°C). Then, press the DOWN (  ) button twice (x2) in one (1) second to start the FREEZE PROTECTION feature. Press the ON/OFF button to turn off the feature. This feature is only available in HEAT mode.

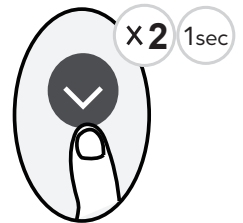
**LOCK** (  )

The LOCK feature disables the remote's buttons so your settings cannot be changed. To activate the remote LOCK feature, simultaneously press the CLEAN and TURBO buttons for five (5) seconds. To turn off the LOCK feature, simultaneously press CLEAN and TURBO again for five (5) seconds.

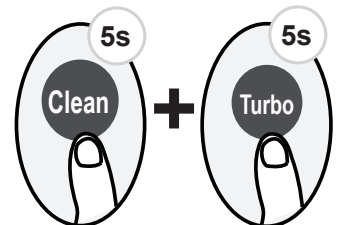
**AUTO-RESTART**

The AUTO-RESTART feature is enabled when power is interrupted to the unit. After power is restored, the unit will automatically return to its prior settings before power was lost. No buttons need to be pressed to set this feature – it is automatic.



## REFRIGERANT LEAK DETECTION (EC)

The indoor unit will automatically display "EC" when it detects a refrigerant leak. If a leak is detected, turn off your unit and contact your dealer or certified technician for service.

## LOUVERED AIR FLOW

### SETTING VERTICAL ANGLE ( )

While the unit is on, press the SWING button on the remote control to set the vertical direction of airflow.

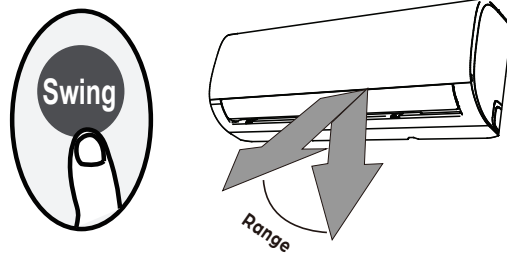

### AUTOMATIC SWING ( )

Press the SWING button once to start the automatic vertical (up and down) movement of the louver. Press again to make it stop.

### FIXED LOUVER ANGLE ( )

Quickly press the SWING button 2–6 times to adjust the fixed angle of the louver. Each press will adjust the louver by 6°. Press the button until the desired angle is reached. The remote will display the selected angle.



#### NOTE

Do not move louver by hand. This will cause the louver to become out of sync. If this occurs, turn off the unit and shut off the breaker for 30 seconds, then restart the unit. This will reset the louver.

## SETTING HORIZONTAL ANGLE

The horizontal angle of the airflow must be set manually. Grip the deflector rod and manually adjust it to your preferred direction.

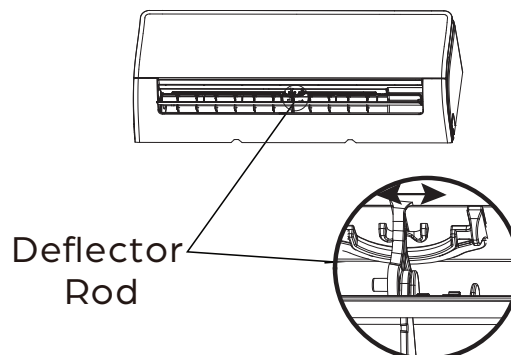

#### CAUTION

Do not put your fingers in or near the blower and suction side of the unit. The high-speed fan inside the unit may cause injury.

## LED DISPLAY INDICATORS

The following is a list of possible indicators that may appear on the indoor unit's display. Not all the display indicators may be available on the unit purchased.

Feature	Indicator	Notes
TIMER ON, SWING, TURBO, SILENCE	ON	Displays for 3 seconds when the TIMER ON feature is set or the SWING, TURBO, or SILENCE feature is turned on. If the unit is off, ON will continue to be shown if the TIMER ON feature is set.
TIMER OFF, SWING, TURBO, SILENCE	OF	Displays for 3 seconds when the TIMER OFF feature is set or the SWING, TURBO, or SILENCE feature is turned off.
CLEAN	CL	Displays when the CLEAN feature is on.
FREEZE PROTECTION	FP	Displays when the FREEZE PROTECTION feature is on.
FORCED COOLING	FC	Displays when the FORCED COOLING mode is selected with the manual control button. See Manual Operation section.
ANTI-COLD AIR FLOW	cF	The unit is designed not to blow cold air in HEAT mode. When HEAT mode is selected the unit will display "cF" until the set temperature is reached and the unit can blow warm air.
DEFROST	dF	Displays when unit is defrosting. This may last 5-10 minutes depending on the outdoor temperature and the amount of frost buildup on the outside unit.
REFRIGERANT LEAK	EC	Displays if a refrigerant leak is detected. Turn off your unit and contact your dealer or certified technician for service.

## MANUAL OPERATION (USE WITHOUT REMOTE)

The manual override button is intended for testing purposes and emergency operation. Please do not use this button unless the remote control is lost and it is absolutely necessary. The unit must be turned off before manual operation.

To operate your unit manually:

1. Open the front panel of the indoor unit.
2. Locate the MANUAL CONTROL button on the right-hand side of the unit.
3. Press the MANUAL CONTROL button one time to activate FORCED AUTO mode.
4. Press the MANUAL CONTROL button again to activate FORCED COOLING mode.
5. Press the MANUAL CONTROL button a third time to turn the unit off.
6. Close the front panel.

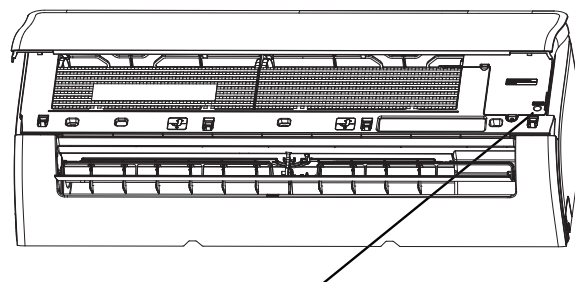

Manual Control  
Button

## CARE AND MAINTENANCE



### CAUTION

- Always turn off the unit and disconnect power before cleaning or maintenance.
- Only use a soft, dry cloth to wipe the unit clean. If the unit is especially dirty, you can use a cloth soaked in warm water to wipe it clean.

### CLEANING INDOOR UNIT

- Do not use chemicals or chemically treated cloths to clean the unit.
- Do not use benzene, paint thinner, polishing powder or other solvents to clean the unit. They can cause the plastic surface to crack or deform.
- Do not use water hotter than 104°F (40°C) to clean the front panel. This can cause the panel to deform or become discolored.

### CLEANING THE AIR FILTER

A dirty air filter can reduce the cooling efficiency of your unit, and can also be bad for your health. Make sure to clean the filter once every two weeks.

1. Lift the front panel of the indoor unit.
2. Grip the tab on the end of the filter, lift it up, then pull it towards yourself.
3. Now pull the filter out.
4. If your filter has a small air freshening filter, unclip it from the larger filter. Clean this air freshening filter with a hand-held vacuum.
5. Clean the large air filter with warm, soapy water. Be sure to use a mild detergent.
6. Rinse the filter with fresh water, then shake off excess water.
7. Dry filter in a cool, dry place, and refrain from exposing it to direct sunlight.
8. When dry, re-clip the air freshening filter to the larger filter, then slide it back into the indoor unit.
9. Close the front panel of the indoor unit.

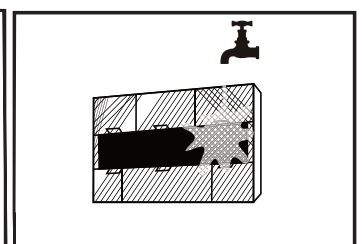
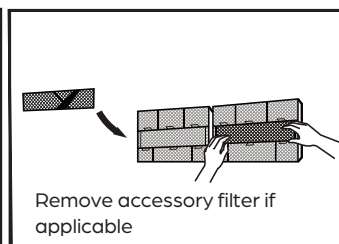
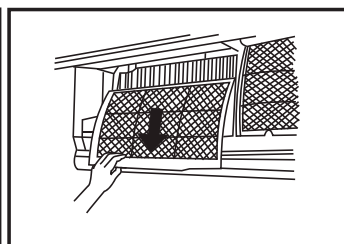
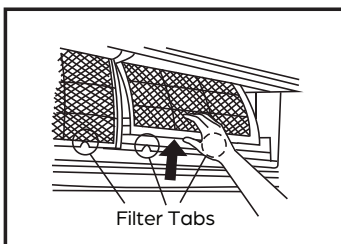

### CAUTION



- Before changing the filter or cleaning, turn off the unit and disconnect its power supply.
- When removing the filter, do not touch the metal parts in the unit. The sharp metal edges can cut you.
- Do not use water to clean the inside of the indoor unit. This can destroy insulation and cause electrical shock.
- Do not expose filter to direct sunlight when drying. This can shrink the filter.

**MAINTENANCE: LONG PERIODS OF NON-USE**

If you do not plan to use your air conditioner for an extended period of time, do the following:

- Clean all filters.
- Turn on the FAN until the unit dries out completely.
- Turn off the unit and disconnect the power.
- Remove batteries from remote control.

**MAINTENANCE: PRE-SEASON INSPECTION**

After long periods of non-use, or before periods of frequent use, do the following:

- Inspect for damaged wires.
- Clean all filters.
- Check for leaks.
- Replace batteries.
- Make sure nothing is blocking any air inlets or outlets.

# TROUBLESHOOTING

## SAFETY PRECAUTIONS

If ANY of the following conditions occur, turn off your unit immediately!

- The power cord is damaged or abnormally warm
- You smell a burning odor
- The unit emits loud or abnormal sounds
- A power fuse blows or the circuit breaker frequently trips
- Water or other objects fall into or out of the unit

**DO NOT ATTEMPT TO FIX THESE YOURSELF! CONTACT AN AUTHORIZED SERVICE PROVIDER IMMEDIATELY!**

## COMMON ISSUES

The following problems are not malfunctions and in most situations do not require repairs.

ISSUE	POSSIBLE CAUSES
<b>Unit does not turn on when pressing ON/OFF button</b>	The unit has a 3-minute protection feature that prevents the unit from overloading. The unit cannot be restarted within three minutes of being turned off.
<b>The unit changes from COOL/HEAT mode to FAN mode</b>	The unit may change its setting to prevent frost from forming on the unit. Once the temperature increases, the unit will start operating in the previously selected mode again.
	The set temperature has been reached, at which point the unit turns off the compressor. The unit will continue operating when the temperature fluctuates again.
<b>The indoor unit emits white mist</b>	In humid regions, a large temperature difference between the room's air and the conditioned air can cause white mist.
<b>Both the indoor and outdoor units emit white mist</b>	When the unit restarts in HEAT mode after defrosting, white mist may be emitted due to moisture generated during the defrosting process.
<b>The indoor unit makes noises</b>	A rushing air sound may occur when the louver resets its position.
	A squeaking sound may occur after running the unit in HEAT mode due to expansion and contraction of the unit's plastic parts.

ISSUE	POSSIBLE CAUSES
<b>Both the indoor unit and outdoor unit make noises</b>	Low hissing sound during operation: This is normal and is caused by refrigerant gas flowing through both indoor and outdoor units.
	Low hissing sound when the system starts, has just stopped running, or is defrosting: This noise is normal and is caused by the refrigerant gas stopping or changing direction.
	Squeaking sound: Normal expansion and contraction of plastic and metal parts caused by temperature changes during operation can cause squeaking noises.
<b>The outdoor unit makes noises</b>	The unit will make different sounds based on its current operating mode.
<b>Dust is emitted from either the indoor or outdoor unit</b>	The unit may accumulate dust during extended periods of non-use, which will be emitted when the unit is turned on. This can be mitigated by covering the unit during long periods of inactivity.
<b>The unit emits a bad odor</b>	The unit may absorb odors from the environment (such as furniture, cooking, cigarettes, etc.) which will be emitted during operations.
	The unit's filters have become moldy and should be cleaned.
<b>The fan of the outdoor unit does not operate</b>	During operation, the fan speed is controlled to optimize product operation.
<b>Operation is erratic, unpredictable, or unit is unresponsive</b>	Interference from cell phone towers and remote boosters may cause the unit to malfunction. In this case, try the following: <ul style="list-style-type: none"> <li>• Disconnect the power, then reconnect.</li> <li>• Press ON/OFF button on remote control to restart operation.</li> </ul>

**NOTE**



If problem persists, contact a local dealer or your nearest customer service center. Provide them with a detailed description of the unit malfunction as well as your model number.

## TROUBLESHOOTING

If trouble occurs, please check the following points before contacting a repair company.

PROBLEM	POSSIBLE CAUSES	SOLUTION
<b>Poor cooling performance</b>	Temperature setting may be higher than ambient room temperature.	Lower the temperature setting.
	The heat exchanger on the indoor or outdoor unit is dirty.	Clean the affected heat exchanger.
	The air filter is dirty.	Remove the filter and clean it according to instructions.
	The air inlet or outlet of either unit is blocked.	Turn the unit off, remove the obstruction and turn it back on.
	Doors and windows are open.	Make sure that all doors and windows are closed while operating the unit.
	Excessive heat is generated by sunlight.	Close windows and curtains during periods of high heat or bright sunshine.
	Low refrigerant due to leak or long-term use.	Check for leaks, re-seal if necessary and top off refrigerant.
	Too many sources of heat in the room (people, computers, electronics, etc.).	Reduce amount of heat sources.
<b>Poor heating performance</b>	The outdoor temperature is extremely low.	Use auxiliary heating device.
	Cold air is entering through doors and windows.	Make sure that all doors and windows are closed during use.
	Low refrigerant due to leak or long-term use.	Check for leaks, re-seal if necessary and top off refrigerant.
<b>The unit starts and stops frequently</b>	There's too much or too little refrigerant in the system.	Check for leaks and recharge the system with refrigerant.
	Incompressible gas or moisture has entered the system.	Evacuate and recharge the system with refrigerant.
	The compressor is broken.	Replace the compressor.
	The voltage is too high or too low.	Install a manostat to regulate the voltage.
<b>Indicator lamps continue flashing or error code appears</b>	<p>The unit may stop operation or continue to run safely. If the indicator lamps continue to flash or error codes appear, wait for about 10 minutes. The problem may resolve itself.</p> <p>If not, disconnect the power, then connect it again. Turn the unit on.</p> <p>If the problem persists, disconnect the power and contact your nearest customer service center.</p>	

<b>PROBLEM</b>	<b>POSSIBLE CAUSES</b>	<b>SOLUTION</b>
<b>The unit is not working</b>	Power failure	Wait for the power to be restored
	The power is turned off	Turn on the power
	The fuse is burned out	Replace the fuse
	Remote control batteries are dead	Replace the batteries
	The unit's 3-minute protection has been activated	Wait three minutes after restarting the unit
	Timer is activated	Turn timer off

**NOTE**

If your problem persists after performing the checks and diagnostics above, or an error code remains, turn off your unit immediately and contact an authorized service center.



**THIS PAGE INTENTIONALLY LEFT BLANK.**

## LIMITED WARRANTY – PARTS

### TEN (10) YEARS PARTS

Subject to all of the terms of this Limited Warranty, including, but not limited to, the specific exclusions set forth below and subject to the Manufacturer's right to inspect and validate the warranty claim as set forth below, Manufacturer will repair or replace, at its option, ANY PART of Covered Equipment that is found to be defective in materials or workmanship. If an exact replacement part is not available, an equivalent part or credit will be provided.

The parts are warranted for a period of ten (10) years to the original owner of the mini-split equipment under normal use and service. For a period of ten (10) years from the date of installation, if any parts prove defective due to improper workmanship and/or material, Durastar will replace any defective part without charge for the part. Replacement parts carry the balance of the original 10-year parts warranty.

To qualify:

- The mini-split equipment must be installed in a residential single-family home.\*
- The original mini-split equipment owner must reside in the single-family home.
- The mini-split equipment must be properly installed. This includes installation by a contractor licensed for HVAC installation following all local and state laws.
- Any part to be replaced must be made available in exchange for the replacement.

\*Single-family home is defined as any single-family dwelling, which includes apartments, condominiums, duplexes, and homes.

### EFFECTIVE DATE OF WARRANTY

The Effective Date of warranty coverage is determined as follows: (a) If the original installation date can be verified by the installer's invoice then the Effective Date of warranty coverage is the original installation date as shown on the installer's invoice. For residential new construction installations, the final occupancy permit, or proof of purchase from the builder can be substituted for the installer's invoice. (b) if the original installation date cannot be verified by the installer's invoice, or proof of purchase from the builder in residential new construction applications, then the Effective Date of warranty coverage is the Covered Equipment's manufacture date (as verified by the product's serial number) plus ninety (90) days.

There is NO LABOR component provided with this warranty. This Limited Warranty does NOT cover any labor costs or expenses for service, NOR for removing or reinstalling parts. You are responsible for all labor costs or expenses, unless a labor service agreement exists between you and your contractor.

This Limited Warranty does NOT cover shipping costs. You are responsible for the cost of shipping warranty replacement parts from our factory to the Manufacturer's distributor and from the distributor to the location of your Covered Equipment. You also are responsible for the cost of shipping failed parts to the distributor and for incidental costs incurred locally, including handling charges. (If in Alaska, Hawaii or Canada, you also must pay the shipping costs of returning the failed part to the port of entry into the continental United States.)

### EXCLUSIONS

In addition to the other exclusions identified in this Limited Warranty, this Limited Warranty excludes:

- Damages, malfunctions, or failures resulting from failure to properly install, operate, or maintain Covered Equipment in accordance with the Manufacturer's instructions.
- Damages, malfunctions, or failures resulting from misuse, accident, contaminated, or corrosive atmosphere, vandalism, freight damage, fire, flood, freeze, lightning, acts of war, acts of God and the like.
- Parts installed with Covered Equipment or used in connection with normal maintenance, such as cleaning or replacing air filters, refrigerant, thermostats, tubing, or concrete pads.
- Covered Equipment that is not installed in the United States.

- Covered Equipment that is not installed by a qualified, trained HVAC professional in accordance with applicable codes, ordinances, and good trade practices.
- Damages, malfunctions, or failures resulting from the use of any attachment, accessory, or component not authorized by the Manufacturer or resulting from alteration or modification of the unit.
- Covered Equipment moved from the original installation location.
- Covered Equipment when operated with system components (indoor unit, outdoor unit, coil, and refrigerant control devices) or accessories which do not match or meet the specifications recommended by the Manufacturer.
- Any Covered Equipment manufactured that has been sold to the consumer via the Internet or auction website, and has not been installed by a trained, qualified HVAC professional.
- Covered Equipment that is not part of a properly matched system as specified by the Air Conditioning, Heating & Refrigeration Institute (AHRI).

#### COMMERCIAL WARRANTY

Installations in commercial applications carry a ONE (1) YEAR PARTS warranty following the other provisions in this Limited Warranty.

#### OBTAINING WARRANTY SERVICE

If you believe your product is defective, contact the licensed contractor who installed your mini-split system. Alternatively, contact a licensed contractor, dealer, or distributor.

Durastar Customer Support is available for troubleshooting assistance. Before contacting Customer Support, please locate your model number, serial number, and proof of purchase. These items will be required to complete any warranty service. A Durastar authorized representative will verify warranty eligibility and determine appropriate service options. Service will be provided during normal business days and hours.

THIS WARRANTY IS IN LIEU OF ANY OTHER WARRANTY, EXPRESS OR IMPLIED, INCLUDING WITHOUT LIMITATION, ANY WARRANTY OF MERCHANTABILITY OR FITNESS FOR A PARTICULAR PURPOSE. TO THE EXTENT ANY IMPLIED WARRANTY IS REQUIRED BY LAW, IT IS LIMITED IN DURATION TO THE EXPRESS WARRANTY PERIOD ABOVE. NEITHER THE MANUFACTURER NOR ITS DISTRIBUTORS SHALL BE LIABLE FOR ANY INCIDENTAL, CONSEQUENTIAL, INDIRECT, SPECIAL, OR PUNITIVE DAMAGES OF ANY NATURE, INCLUDING WITHOUT LIMITATION, LOST REVENUES OR PROFITS, OR ANY OTHER DAMAGE WHETHER BASED IN CONTRACT, TORT, OR OTHERWISE. IN NO EVENT AND UNDER NO CIRCUMSTANCE OF ANY TYPE OR KIND SHALL THE SELLER, MANUFACTURER AND/OR DISTRIBUTOR BE LIABLE FOR ANY REASON, UNDER ANY THEORY, FOR MORE THAN THE BASIC COST OF THE PRODUCT TO THE PURCHASER OR END USER. SOME STATES DO NOT ALLOW THE EXCLUSION OF INCIDENTAL OR CONSEQUENTIAL DAMAGES, SO THE ABOVE EXCLUSION MAY NOT APPLY TO YOU. THIS WARRANTY GIVES YOU SPECIFIC LEGAL RIGHTS. YOU MAY HAVE OTHER RIGHTS THAT VARY FROM STATE TO STATE.



OWNER'S MANUAL

**WALL MOUNTED INDOOR UNIT  
SPLIT-STYLE AIR CONDITIONER**

DRAW06F1B, DRAW09F1B, DRAW12F1B,  
DRAW18F1B, DRAW24F1B

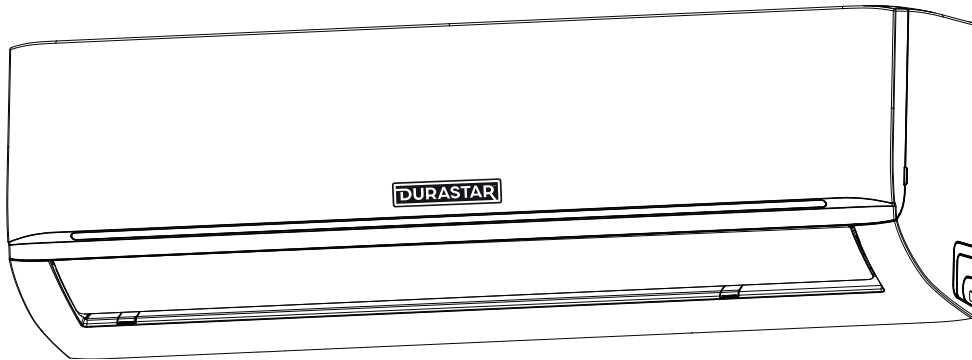

Model Number:

Serial Number:

Purchase Date:

Installing Contractor Company Name:



**TIP**

Capture relevant information about your Durastar mini-split equipment before it is installed and write it above for future reference.

## TABLE OF CONTENTS

TABLE OF CONTENTS .....	2
INTRODUCTION .....	3
WARNINGS .....	3
IMPORTANT SAFETY PRECAUTIONS.....	4
PARTS IDENTIFICATION .....	7
INCLUDED ACCESSORIES .....	8
OPERATING TEMPERATURES.....	9
REMOTE CONTROL.....	10
REMOTE CONTROL SCREEN INDICATORS .....	11
OPERATING MODES .....	12
ADVANCED BUTTONS AND FEATURES .....	13
LOUVERED AIR FLOW .....	17
LED DISPLAY INDICATORS.....	18
MANUAL OPERATION (USE WITHOUT REMOTE) .....	18
CARE AND MAINTENANCE .....	19
TROUBLESHOOTING.....	21
LIMITED WARRANTY - PARTS.....	26

## INTRODUCTION

To better serve you, please do the following before contacting customer service:

- If you received a damaged product, immediately contact the retailer or dealer that sold you the product.
- Read and follow this owner's manual carefully to help you use and maintain your air conditioner.
- Read the troubleshooting section of this manual as it will help you diagnose and solve common issues.
- Visit us on the web at [www.durastar.com](http://www.durastar.com) to download product guides and up-to-date information.
- If you need warranty service, our friendly customer service representatives are available via email at [questions@durastar.com](mailto:questions@durastar.com) or by telephone at 1-888-320-0706.

## WARNINGS

### Symbols Used in This Manual



The warning symbol indicates cautionary information for the user. Extra care and precautions should be taken to ensure the user's safety.



The pencil indicates any manufacturer notes relating to surrounding content. These may include further clarifications or call-outs.



A light bulb symbol indicates suggested manufacturer tips for the user to get the most out of the Durastar equipment and to accommodate the best user experience.

## IMPORTANT SAFETY PRECAUTIONS

Improper handling can cause serious damage or injury. Please read the following safety information in its entirety.



### **Operation, Cleaning, and Maintenance Safety Precautions**

- Children and people with reduced physical, sensory, or mental capabilities, or lack of experience and knowledge, should only use this air conditioner if they are given supervision or instructions concerning use of the air conditioner in a safe way and understand the hazards involved.
- Children should not play with the air conditioner.
- Never stick fingers or any other body parts into the air conditioner openings. The internal fan may be rotating at high speeds, and may result in injury.
- After removing the filter, do not touch the fins in order to avoid injury.
- Maintenance must be performed by qualified professionals. Otherwise, you may experience personal injury or damage to the air conditioner and surrounding property.
- Do not repair the air conditioner by yourself. It may cause electric shock or damage. Please contact a qualified service representative when you need to repair the air conditioner.
- Do not block the air outlet or air inlet. This could cause a malfunction.
- Do not spill water on the remote control as this can permanently damage the remote.
- If the below problems occur, please turn off the air conditioner and disconnect power at the circuit breaker immediately. Then contact your dealer or a qualified professional for service.
  - The power cord is overheating or damaged.
  - There is an abnormal sound during operation.
  - The circuit breaker trips frequently.
  - The air conditioner gives off a burning smell.
  - The indoor unit is leaking.
- If the air conditioner operates under abnormal conditions, it may cause malfunctions, electric shock, or fire hazard.
- When turning the unit on or off via the emergency operation switch, press the switch with an insulated object other than metal.
- Do not step on the top panel of the unit, or put heavy objects on the top panel. This could cause damage or personal injury.
- Cleaning and user maintenance should not be performed by children without supervision.
- Do not spray water on the indoor unit. This could cause electric shock or a unit malfunction.
- Do not use flammable materials such as hair spray, lacquer, or paint near the air conditioner as they may catch fire.
- Do not operate the air conditioner in places near combustible gases. Emitted gases may collect around the air conditioner and cause an explosion.
- Do not use fire or a hair dryer to dry the filter. This could cause a deformation or fire hazard.
- Do not wash the air conditioner with water as this could cause an electric shock.
- Disconnect the power supply by turning it off at the circuit breaker when cleaning the air conditioner. Otherwise, you could risk electric shock.



**Electrical Safety**

- Do not modify the length of the power supply cord or use an extension cord to power the unit.
- If the supply cord is damaged, it must be replaced by the manufacturer, a service agent, or a similarly qualified person in order to avoid a safety hazard.
- Do not share the electrical outlet with other appliances. Improper or insufficient power supply can cause fire or electrical shock.
- The product must be properly grounded at the time of installation, or electrical shock may occur.
- For all electrical work, follow all local and national wiring standards and regulations. Connect cables tightly, and clamp them securely to prevent external forces from damaging the terminal. Improper electrical connections can overheat and cause fire, and may also cause shock. All electrical connections must be made according to the Electrical Connection Diagram located on the panels of the indoor and outdoor units.
- All wiring must be properly arranged to ensure that the control board cover can close properly. If the control board cover is not closed properly, it can lead to corrosion and cause the connection points on the terminal to heat up, catch fire, or cause electrical shock.
- The air conditioner's circuit board (PCB) is designed with a fuse to provide overcurrent protection. The specifications of the fuse are printed on the circuit board.



### **Installation Safety**

- Installation must be performed by an authorized dealer or specialist. Improper installation can cause water leakage, electrical shock, or fire. (In North America, installation must be performed in accordance with NEC and CEC requirements by authorized personnel only.)
- Installation must be performed according to the installation instructions. Improper installation can cause water leakage, electrical shock, or fire.
- This air conditioner shall be installed in accordance with national and local wiring regulations.
- Contact an authorized service technician for repair or maintenance of this unit.
- Only use the included accessories, parts, and specified parts for installation. Using non-standard parts can cause water leakage, electrical shock, fire, and can cause the unit to fail.
- Install the unit in a firm location that can support the unit's weight. If the chosen location cannot support the unit's weight, or the installation is not done properly, the unit may fall and cause serious injury and damage.
- Install drainage piping according to the instructions in the installation manual. Improper drainage may cause water damage to your home and property.
- Do not install the unit in a location that may be exposed to combustible gas leaks. If combustible gas accumulates around the unit, it may cause a fire.
- Do not turn on the power until all work has been completed.
- When moving or relocating the air conditioner, consult experienced service technicians for disconnection and re-installation of the unit.



### **Additional Precautions**

- Turn off the air conditioner and disconnect the power if you are not going to use it for a long time.
- Turn off the unit during electrical storms to avoid damaging the unit.
- Make sure that water condensation can drain unhindered from the unit.
- Do not operate the air conditioner with wet hands. This may cause electric shock.
- Do not use this device for any other purpose than its intended use.
- Do not climb onto or place objects on top of the outdoor unit.
- Do not allow the air conditioner to operate for long periods of time with doors or windows open, or if the humidity is very high.

# PARTS IDENTIFICATION

## INDOOR UNIT

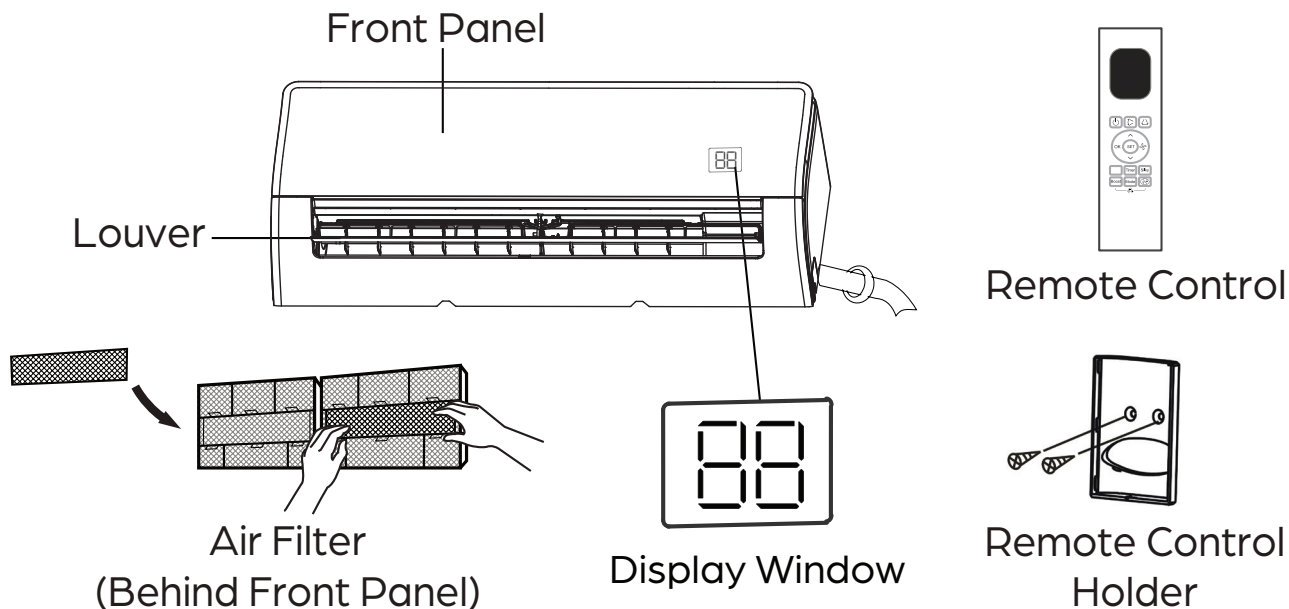

## OUTDOOR UNIT

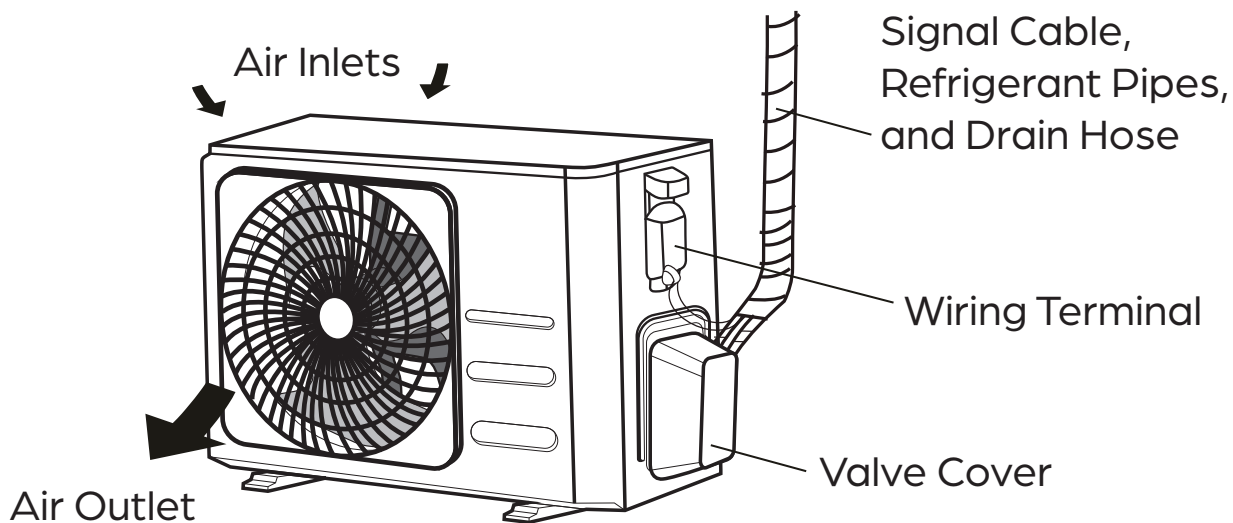









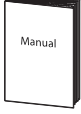

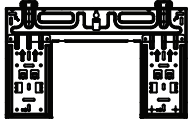
**NOTE**

Outdoor units will vary in appearance.

## INCLUDED ACCESSORIES

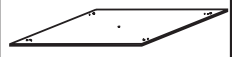
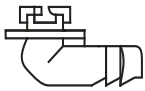
The air conditioning system comes with the following accessories.

Accessory	Quantity	Image	Accessory	Quantity	Image
Manual	1-2		Remote Control	1	
Mounting Plate	1		Battery	2	
Wall Anchor	5-8 (depending on model)		Remote Control Holder	1	
Mounting Plate Screw	5-8 (depending on model)		Remote Control Holder Mounting Screw	2	
Copper Nut	2		Installation Template	1	
Drain Joint	1		Carbon Filter	2	
Drain Joint Seal	1				

## OPERATING TEMPERATURES

Your air conditioner is designed to operate in the following indoor and outdoor temperatures. When your air conditioner is used outside of the following temperature ranges, certain safety features may activate and turn off the unit to protect it from damage.

### TEMPERATURE RANGES

	<b>COOL Mode</b>	<b>HEAT Mode</b>	<b>DRY Mode</b>
<b>Indoor Air Temperature</b>	60°F – 90°F (16°C – 32°C)	32°F – 86°F (0°C – 30°C)	50°F – 90°F (10°C – 32°C)
<b>Outdoor Air Temperature</b>	5°F – 122°F (–15°C – 50°C)	–13°F – 75°F* (–25°C – 24°C)*	32°F – 122°F (0°C – 50°C)

\* The minimum operating temperature depends on the outdoor unit. Low ambient models have a minimum operating temperature in heat mode of –22°F (–30°C).

To further optimize the performance of your unit, do the following:

- Keep doors and windows closed.
- Limit energy usage by using TIMER ON and TIMER OFF features.
- Do not block air inlets or outlets.
- Regularly inspect and clean air filters.

#### NOTE



Your Durastar heat pump's outdoor unit is equipped with a base pan heater, allowing it to continue to operate at freezing temperatures as low as –22°F (–30°C). When outdoor air temperatures are at or below 32°F (0°C), we strongly recommend keeping the unit plugged in at all times to ensure smooth, ongoing performance.

#### NOTE



Keep the room's relative humidity below 80%. If the air conditioner operates in excess of this, the surface of the air conditioner may attract condensation. To help prevent condensation from forming and dripping, set the vertical airflow louver to its maximum angle (vertically to the floor) and set the fan to HIGH.

## REMOTE CONTROL

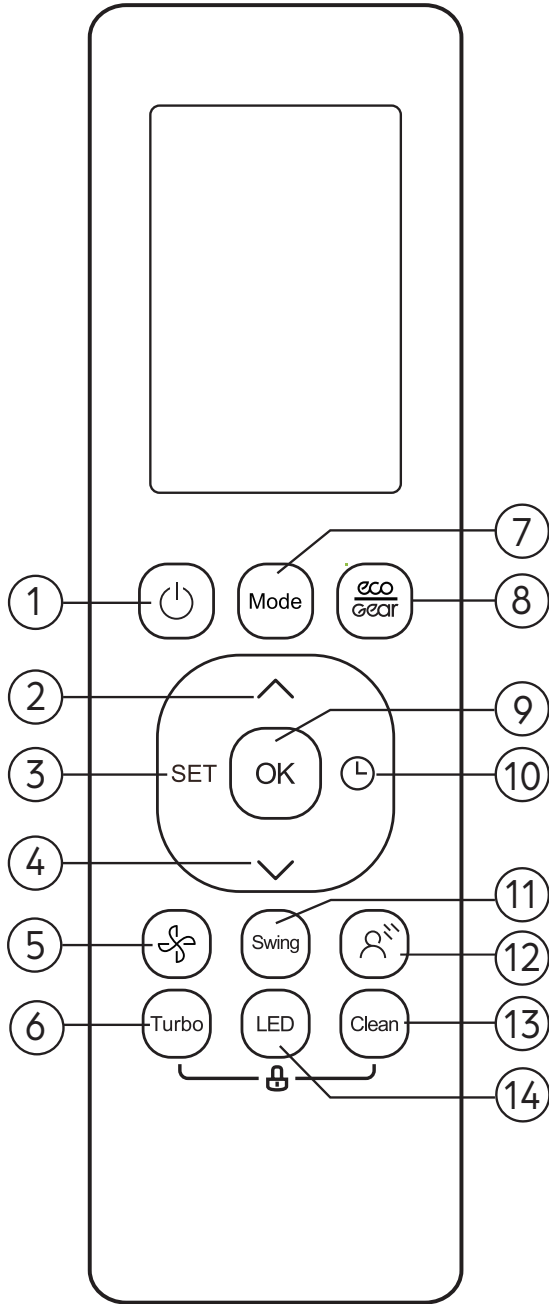

**1. ON/OFF Button**

Turns the air conditioner ON and OFF.

**2. UP Button (▲)**

Press to increase the set temperature in 1°F / 1°C increments .

**3. SET Button**

Press to access the SET features menu. See "Advanced Buttons and Features" section.

**4. DOWN Button (▼)**

Press to decrease the set temperature in 1°F / 1°C increments. Press (▲) and (▼) at the same time for 3 seconds to switch between °F and °C.

**5. FAN Button**

Press to select FAN speed.

**6. TURBO Button**

Press to turn on and off the TURBO feature. See "Advanced Buttons and Features" section.

**7. MODE Button**

Press to adjust the air conditioner MODE in the following sequence: → AUTO → COOL → DRY → HEAT → FAN →

**8. ECO/GEAR Button**

Press to enter one of three energy efficiency modes. See "Advanced Buttons and Features" section.

**9. OK Button**

Press to confirm selected functions.

**10. TIMER Button**

Press to initiate the TIMER feature. See "Advanced Buttons and Features" section.

**11. SWING Button**

Press to start and stop the automatic horizontal louver movement or set a fixed louver angle.

**12. GENTLE Button**

Press to stop the air flow from blowing directly on you if it becomes uncomfortable. See "Advanced Buttons and Features" section.

**13. CLEAN Button**

Turns on and off the CLEAN feature. See "Advanced Buttons and Features" section.

**14. LED Button**

Press to turn on and off the indoor unit's display screen.

# REMOTE CONTROL SCREEN INDICATORS

## Transmission Indicator

Lights up when remote sends signal to indoor unit.



**TIMER ON** display



**TIMER OFF** display



**SILENCE** feature display

## FAN SPEED display

Displays selected fan speed:

Silence		1%
		2%-20%
LOW		21%-40%
MED		41%-60%
		61%-80%
HIGH		81%-100%
AUTO	<u>AUTO</u>	

The fan speed cannot be adjusted in AUTO or DRY mode.

Note:

Not all the models can display the fan speed values between AUTO-100%.

- GENTLE** feature display
- CLEAN** feature display
- SLEEP** feature display
- FOLLOW ME** feature display
- Network display (not available for this unit)
- Low battery display (If flashing)

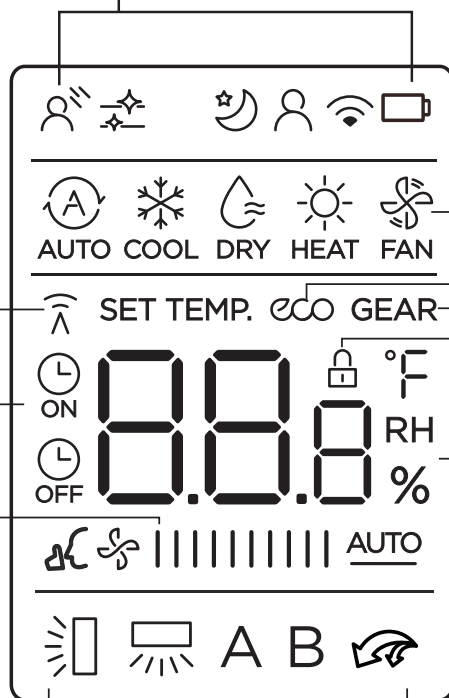

## MODE display

Displays the current mode, including:



## ECO display

Displays when ECO feature is activated.

## GEAR display

Displays when GEAR feature is activated.

## LOCK display

Displays when LOCK feature is activated.

Temperature/Timer/ Fan Speed % display  
Displays the set temperature unless the fan speed or timer setting functions are in use.

## TIMER ON/OFF functions.

- Temperature range: 60-86°F (16-30°C)
- Timer setting range: 0-24 hours
- Fan speed setting range: AUTO -100%

This display is blank when operating in **FAN** mode.

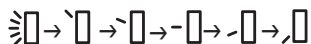

**Horizontal** louver swing display



**Vertical** louver swing (not available on unit)



**TURBO** feature display



**A** Not available for this unit



**B** Not available for this unit





## NOTE

All indicators shown in the above figure are for purposes of clear representation. During actual operation, only the relative indicators are illuminated in the display window.

## OPERATING MODES ( )

### SETTING TEMPERATURE

This unit can be set at any temperature within its operating range in AUTO, COOL, HEAT, and DRY modes (see "Temperature Ranges" section). You can increase or decrease the set temperature in 1°F (1°C) increments by pressing the UP (  ) or DOWN (  ) button.

### AUTO ( )

In AUTO mode, the unit will automatically select the COOL, FAN, HEAT, or DRY modes to maintain the set temperature. In AUTO mode, the fan speed cannot be set.

1. Select AUTO mode
2. Set desired temperature
3. Turn on air conditioner

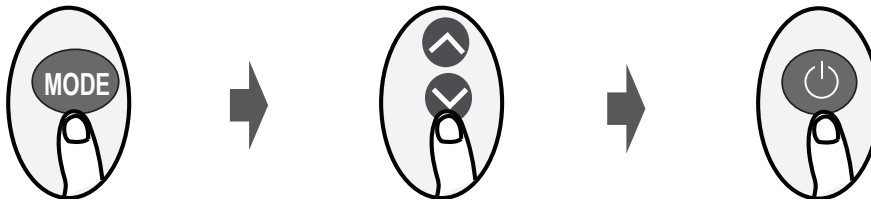

### COOL or HEAT ( or )

1. Select COOL or HEAT mode
2. Set desired temperature
3. Set fan speed
4. Turn on air conditioner

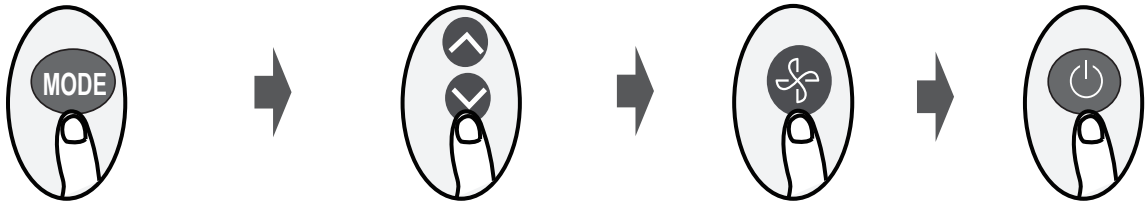

### DRY/DEHUMIDIFY ( )

In DRY mode, the fan runs continuously on low speed. The unit will operate continuously until it reaches 50°F (10°C), at which time it will turn off. DRY mode operation will then resume once the room temperature reaches 54°F (12°C).

1. Select DRY mode
2. Set any temperature
3. Turn on air conditioner

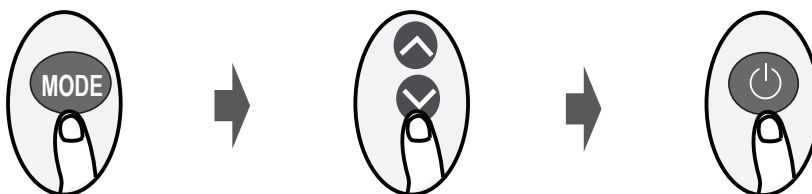

#### NOTE

\*For this series of mini-splits, changing the temperature in DRY mode does not deviate performance from the above mode description.



#### NOTE

The FAN speed cannot be adjusted in AUTO or DRY Mode.



#### NOTE

Press and hold the UP and DOWN buttons simultaneously for 3 seconds to switch between °F and °C.



## FAN ( )

In FAN mode, the temperature cannot be set and no temperature will be displayed on the remote screen.

1. Select FAN mode

2. Set fan speed

3. Turn on air conditioner



### NOTE

You cannot adjust the temperature in FAN mode. As a result, your remote control's LCD display will not display a temperature.



### NOTE

As outdoor temperature drops, the performance of your unit's HEAT function may be affected.



### NOTE

Two or more indoor units can be operated by one outdoor unit. However, two or more indoor units cannot operate simultaneously when different operating modes have been selected. If COOL/DRY/FAN is selected with one or more indoor units and HEAT with another, the unit(s) in HEAT has priority.

## ADVANCED BUTTONS AND FEATURES

### ECO/GEAR ( )

The ECO/GEAR feature provides three levels of energy saving options. ECO/GEAR is only available in COOL mode. Some of these options may result in insufficient cooling in circumstances of high ambient heat. The ECO/GEAR feature is not available in multiple zone configurations.

#### ECO ( *eco* )

While the unit is in COOL mode, press the ECO/GEAR button once. If the set temperature is above 75°F (24°C) the FAN speed will be set to AUTO. If the set temperature is below 75°F (24°C) it will automatically be adjusted to 75°F (24°C) and the FAN speed will be set to AUTO. When functioning in this mode, the unit can reduce its energy consumption up to 10%. Press the ECO/GEAR button to turn off this feature.

#### GEAR ( GEAR )

GEAR has two levels – 25% and 50% energy consumption. While the unit is in COOL mode, press the ECO/GEAR button twice (x2) within two (2) seconds to select 25% or three times (x3) to select 50%. If the set temperature is above 75°F (24°C) the FAN speed will be set to AUTO. If the set temperature is below 75°F (24°C) it will automatically be adjusted to 75°F (24°C) and the FAN speed will be set to AUTO. When functioning in these modes, the unit can reduce its energy consumption up to 25% or 50%. Press the ECO/GEAR button to turn off this feature.



### NOTE

The overall energy consumption of the unit is affected by many factors and this feature's energy reduction level setting will not result in directly proportional money savings on your energy bill.

## SET BUTTON FEATURES ( SET )

Press the SET button to open the feature menu at the top of the display. Next, press SET or UP (▲) and DOWN (▼) to highlight the desired feature's icon. Finally, press OK to activate it.

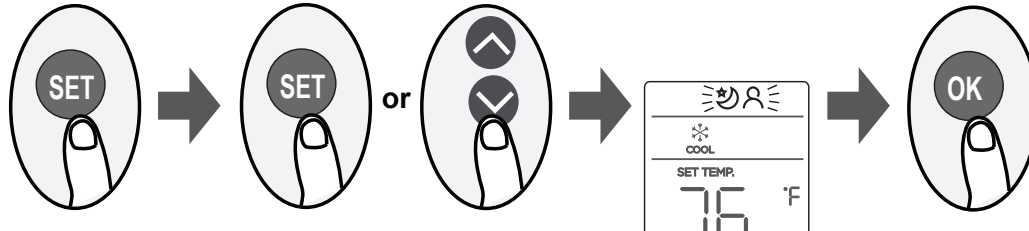

## SLEEP ( 🌙 )

The SLEEP feature is designed to decrease energy use while you sleep. The SLEEP feature is not available in FAN or DRY mode.

When you are ready to go to sleep, press the SET button, select the SLEEP icon and press OK. When in COOL mode, the unit will increase the temperature by 2°F (1°C) after one hour, and will increase an additional 2°F (1°C) after another hour. When in HEAT mode, the unit will decrease the temperature by 2°F (1°C) after one hour, and will decrease an additional 2°F (1°C) after another hour.

The SLEEP feature will turn off after eight hours and the system will return to normal functioning.

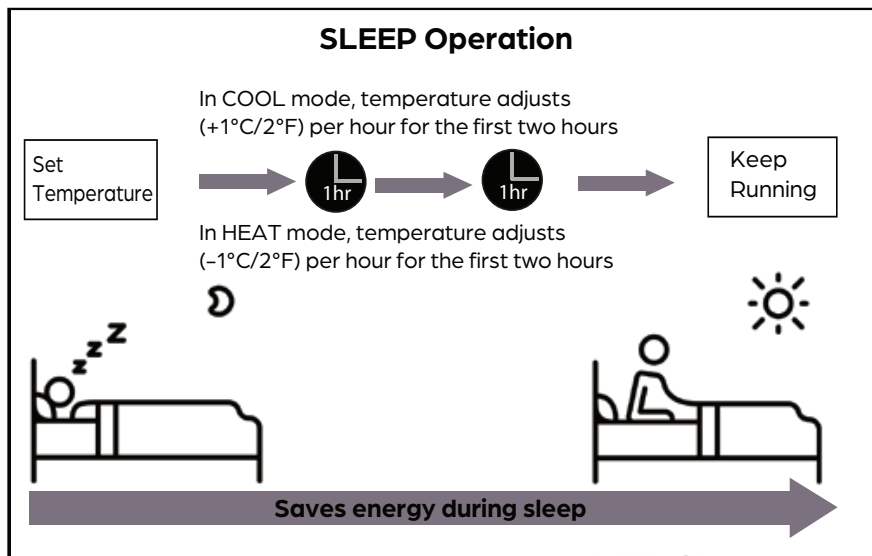

## FOLLOW ME ( 👤 )

This feature uses the temperature at the remote's location, instead of the indoor unit's location, to optimize the temperature around you and ensure maximum comfort. To activate the FOLLOW ME feature, press the SET button, select the FOLLOW ME icon and press OK. To deactivate FOLLOW ME press ON/OFF or change the MODE.

To lock the FOLLOW ME feature, press and hold the TURBO button for seven (7) seconds. The remote will display "ON" for three (3) seconds and the temperature at its location. When using AUTO, COOL, and HEAT modes the air conditioner will continue running until the temperature at the remote's location is satisfied. Power failures, pressing ON/OFF or changing MODES will no longer cancel the feature. Press and hold the TURBO button again for seven (7) seconds to unlock and turn off this feature. The remote will display "OF" for three (3) seconds.

## NETWORK SETUP ( 📶 )

This feature is not available on this unit.

**TIMER (🕒)**

The TIMER feature establishes the amount of time that will elapse before the unit will automatically turn on/off.

1. Press TIMER button to initiate the time ON sequence.
2. Press UP or DOWN button the required number of times to set the desired time to turn on the unit.
3. Point remote at unit for 1 second. The TIMER ON will be activated.

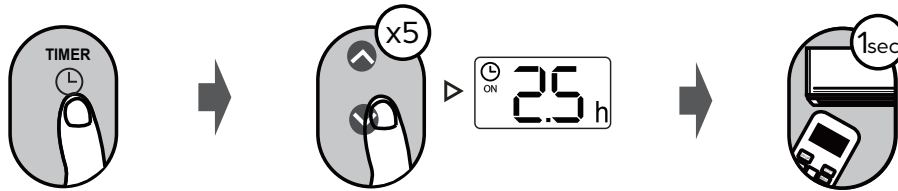

1. Press TIMER button to initiate the time OFF sequence.
2. Press UP or DOWN button the required number of times to set the desired time to turn on the unit.
3. Point remote at unit for 1 second. The TIMER OFF will be activated.

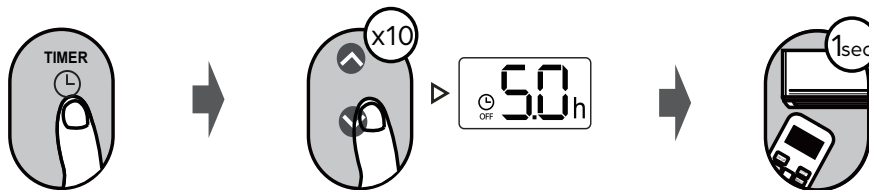

**TIMER ON and OFF setting example.**

Keep in mind that the time periods you set for both the on and off feature refers to hours after the current time.

If the current time is 1:00 PM and the TIMER ON setting is adjusted to 2.5 hours, the auto-on time sequence will turn the air conditioner on 2.5 hours later at 3:30 PM. Setting the TIMER OFF auto-off sequence to 5.0 hours will turn off the air conditioner 5 hours later at 6:00 PM.

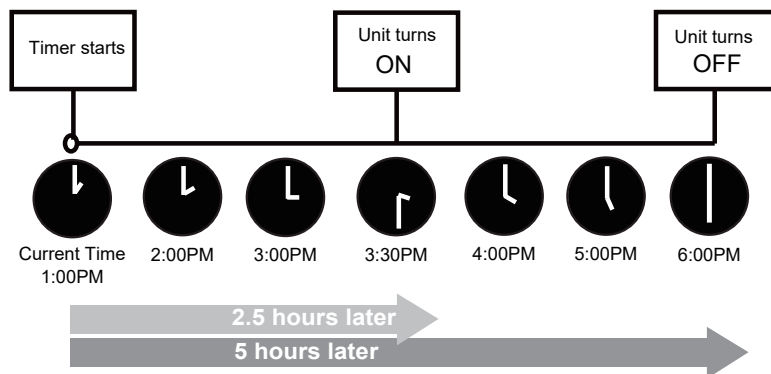

**GENTLE (🌀)**

If the air flow from the unit becomes uncomfortable because it is too intense or blowing directly on you, simply press the GENTLE button to slow the unit and divert the air flow away from you. Press the GENTLE button again to turn this feature off. This feature is only available under COOL, DRY, and FAN modes. This feature is not available in multiple zone configurations.

**TURBO** (  )

Press the TURBO button to turn this feature on and off. The TURBO feature enables the unit to reach the set temperature in the shortest time by automatically controlling the fan speed. This feature is only available in COOL and HEAT modes.

**LED** (  )

Press the LED button to turn on and off the display of the indoor unit.

**CLEAN** (  )

Airborne bacteria can grow in the moisture that condenses around the heat exchanger in the unit. With regular use, most of this moisture is evaporated from the unit. By pressing the CLEAN button, your unit will clean itself automatically. After cleaning, the unit will turn off automatically. Pressing the CLEAN button mid-cycle will cancel the operation and turn off the unit. You can use CLEAN as often as you like. You can only activate the CLEAN function in COOL or DRY modes. This feature is not available in multiple zone configurations.

**SILENCE** (  )

Press the FAN button for two (2) seconds to turn on and off the SILENCE feature. When the SILENCE feature is activated, the compressor will slow and the indoor unit will turn the fan to low. This will reduce the noise of the indoor unit to the lowest level. Due to the slow operation of the compressor, it may result in insufficient cooling and heating capacity. This feature is not available in multiple zone configurations.

**FREEZE PROTECTION (FP)**

The FREEZE PROTECTION feature sets the indoor temperature to 46°F (8°C). The unit will maintain this temperature and prevent indoor pipes and household items from freezing when the house is unoccupied for long periods of time in the winter. The display will show "FP" when this feature is on.

To activate, first turn the unit to HEAT mode and set the temperature to 60°F (16°C). Then, press the DOWN (  ) button twice (x2) in one (1) second to start the FREEZE PROTECTION feature. Press the ON/OFF button to turn off the feature. This feature is only available in HEAT mode.

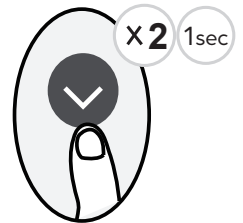
**LOCK** (  )

The LOCK feature disables the remote's buttons so your settings cannot be changed. To activate the remote LOCK feature, simultaneously press the CLEAN and TURBO buttons for five (5) seconds. To turn off the LOCK feature, simultaneously press CLEAN and TURBO again for five (5) seconds.

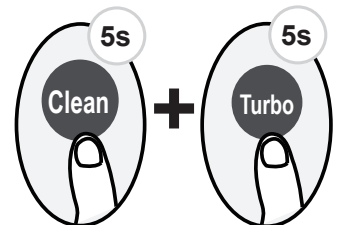
**AUTO-RESTART**

The AUTO-RESTART feature is enabled when power is interrupted to the unit. After power is restored, the unit will automatically return to its prior settings before power was lost. No buttons need to be pressed to set this feature – it is automatic.

## REFRIGERANT LEAK DETECTION (EC)

The indoor unit will automatically display "EC" when it detects a refrigerant leak. If a leak is detected, turn off your unit and contact your dealer or certified technician for service.

## LOUVERED AIR FLOW

### SETTING VERTICAL ANGLE ( )

While the unit is on, press the SWING button on the remote control to set the vertical direction of airflow.

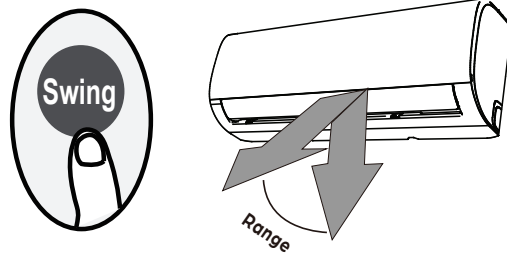

### AUTOMATIC SWING ( )

Press the SWING button once to start the automatic vertical (up and down) movement of the louver. Press again to make it stop.

### FIXED LOUVER ANGLE ( )

Quickly press the SWING button 2–6 times to adjust the fixed angle of the louver. Each press will adjust the louver by 6°. Press the button until the desired angle is reached. The remote will display the selected angle.



#### NOTE

Do not move louver by hand. This will cause the louver to become out of sync. If this occurs, turn off the unit and shut off the breaker for 30 seconds, then restart the unit. This will reset the louver.

## SETTING HORIZONTAL ANGLE

The horizontal angle of the airflow must be set manually. Grip the deflector rod and manually adjust it to your preferred direction.

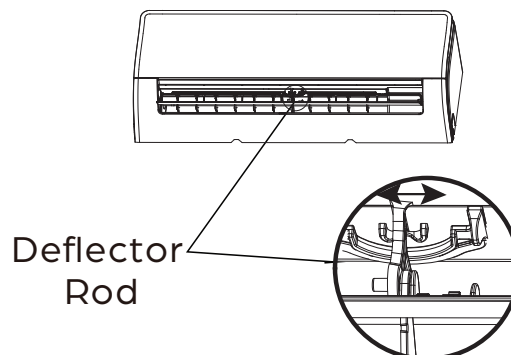

#### CAUTION

Do not put your fingers in or near the blower and suction side of the unit. The high-speed fan inside the unit may cause injury.

## LED DISPLAY INDICATORS

The following is a list of possible indicators that may appear on the indoor unit's display. Not all the display indicators may be available on the unit purchased.

Feature	Indicator	Notes
TIMER ON, SWING, TURBO, SILENCE	ON	Displays for 3 seconds when the TIMER ON feature is set or the SWING, TURBO, or SILENCE feature is turned on. If the unit is off, ON will continue to be shown if the TIMER ON feature is set.
TIMER OFF, SWING, TURBO, SILENCE	OF	Displays for 3 seconds when the TIMER OFF feature is set or the SWING, TURBO, or SILENCE feature is turned off.
CLEAN	CL	Displays when the CLEAN feature is on.
FREEZE PROTECTION	FP	Displays when the FREEZE PROTECTION feature is on.
FORCED COOLING	FC	Displays when the FORCED COOLING mode is selected with the manual control button. See Manual Operation section.
ANTI-COLD AIR FLOW	cF	The unit is designed not to blow cold air in HEAT mode. When HEAT mode is selected the unit will display "cF" until the set temperature is reached and the unit can blow warm air.
DEFROST	dF	Displays when unit is defrosting. This may last 5-10 minutes depending on the outdoor temperature and the amount of frost buildup on the outside unit.
REFRIGERANT LEAK	EC	Displays if a refrigerant leak is detected. Turn off your unit and contact your dealer or certified technician for service.

## MANUAL OPERATION (USE WITHOUT REMOTE)

The manual override button is intended for testing purposes and emergency operation. Please do not use this button unless the remote control is lost and it is absolutely necessary. The unit must be turned off before manual operation.

To operate your unit manually:

1. Open the front panel of the indoor unit.
2. Locate the MANUAL CONTROL button on the right-hand side of the unit.
3. Press the MANUAL CONTROL button one time to activate FORCED AUTO mode.
4. Press the MANUAL CONTROL button again to activate FORCED COOLING mode.
5. Press the MANUAL CONTROL button a third time to turn the unit off.
6. Close the front panel.

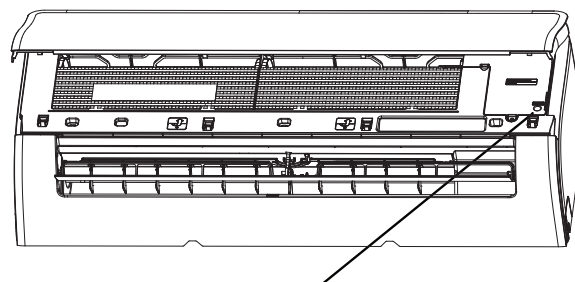

Manual Control  
Button

## CARE AND MAINTENANCE



### CAUTION

- Always turn off the unit and disconnect power before cleaning or maintenance.
- Only use a soft, dry cloth to wipe the unit clean. If the unit is especially dirty, you can use a cloth soaked in warm water to wipe it clean.

### CLEANING INDOOR UNIT

- Do not use chemicals or chemically treated cloths to clean the unit.
- Do not use benzene, paint thinner, polishing powder or other solvents to clean the unit. They can cause the plastic surface to crack or deform.
- Do not use water hotter than 104°F (40°C) to clean the front panel. This can cause the panel to deform or become discolored.

### CLEANING THE AIR FILTER

A dirty air filter can reduce the cooling efficiency of your unit, and can also be bad for your health. Make sure to clean the filter once every two weeks.

1. Lift the front panel of the indoor unit.
2. Grip the tab on the end of the filter, lift it up, then pull it towards yourself.
3. Now pull the filter out.
4. If your filter has a small air freshening filter, unclip it from the larger filter. Clean this air freshening filter with a hand-held vacuum.
5. Clean the large air filter with warm, soapy water. Be sure to use a mild detergent.
6. Rinse the filter with fresh water, then shake off excess water.
7. Dry filter in a cool, dry place, and refrain from exposing it to direct sunlight.
8. When dry, re-clip the air freshening filter to the larger filter, then slide it back into the indoor unit.
9. Close the front panel of the indoor unit.

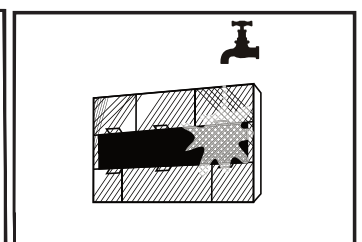
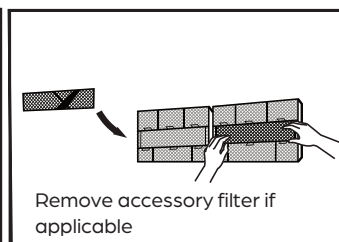
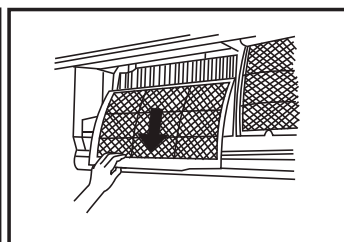
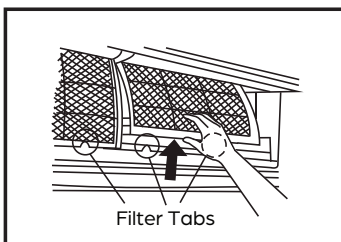

### CAUTION



- Before changing the filter or cleaning, turn off the unit and disconnect its power supply.
- When removing the filter, do not touch the metal parts in the unit. The sharp metal edges can cut you.
- Do not use water to clean the inside of the indoor unit. This can destroy insulation and cause electrical shock.
- Do not expose filter to direct sunlight when drying. This can shrink the filter.

**MAINTENANCE: LONG PERIODS OF NON-USE**

If you do not plan to use your air conditioner for an extended period of time, do the following:

- Clean all filters.
- Turn on the FAN until the unit dries out completely.
- Turn off the unit and disconnect the power.
- Remove batteries from remote control.

**MAINTENANCE: PRE-SEASON INSPECTION**

After long periods of non-use, or before periods of frequent use, do the following:

- Inspect for damaged wires.
- Clean all filters.
- Check for leaks.
- Replace batteries.
- Make sure nothing is blocking any air inlets or outlets.



# TROUBLESHOOTING

## SAFETY PRECAUTIONS

If ANY of the following conditions occur, turn off your unit immediately!

- The power cord is damaged or abnormally warm
- You smell a burning odor
- The unit emits loud or abnormal sounds
- A power fuse blows or the circuit breaker frequently trips
- Water or other objects fall into or out of the unit

**DO NOT ATTEMPT TO FIX THESE YOURSELF! CONTACT AN AUTHORIZED SERVICE PROVIDER IMMEDIATELY!**

## COMMON ISSUES

The following problems are not malfunctions and in most situations do not require repairs.

ISSUE	POSSIBLE CAUSES
<b>Unit does not turn on when pressing ON/OFF button</b>	The unit has a 3-minute protection feature that prevents the unit from overloading. The unit cannot be restarted within three minutes of being turned off.
<b>The unit changes from COOL/HEAT mode to FAN mode</b>	The unit may change its setting to prevent frost from forming on the unit. Once the temperature increases, the unit will start operating in the previously selected mode again.
	The set temperature has been reached, at which point the unit turns off the compressor. The unit will continue operating when the temperature fluctuates again.
<b>The indoor unit emits white mist</b>	In humid regions, a large temperature difference between the room's air and the conditioned air can cause white mist.
<b>Both the indoor and outdoor units emit white mist</b>	When the unit restarts in HEAT mode after defrosting, white mist may be emitted due to moisture generated during the defrosting process.
<b>The indoor unit makes noises</b>	A rushing air sound may occur when the louver resets its position.
	A squeaking sound may occur after running the unit in HEAT mode due to expansion and contraction of the unit's plastic parts.

ISSUE	POSSIBLE CAUSES
<b>Both the indoor unit and outdoor unit make noises</b>	Low hissing sound during operation: This is normal and is caused by refrigerant gas flowing through both indoor and outdoor units.
	Low hissing sound when the system starts, has just stopped running, or is defrosting: This noise is normal and is caused by the refrigerant gas stopping or changing direction.
	Squeaking sound: Normal expansion and contraction of plastic and metal parts caused by temperature changes during operation can cause squeaking noises.
<b>The outdoor unit makes noises</b>	The unit will make different sounds based on its current operating mode.
<b>Dust is emitted from either the indoor or outdoor unit</b>	The unit may accumulate dust during extended periods of non-use, which will be emitted when the unit is turned on. This can be mitigated by covering the unit during long periods of inactivity.
<b>The unit emits a bad odor</b>	The unit may absorb odors from the environment (such as furniture, cooking, cigarettes, etc.) which will be emitted during operations.
	The unit's filters have become moldy and should be cleaned.
<b>The fan of the outdoor unit does not operate</b>	During operation, the fan speed is controlled to optimize product operation.
<b>Operation is erratic, unpredictable, or unit is unresponsive</b>	Interference from cell phone towers and remote boosters may cause the unit to malfunction. In this case, try the following: <ul style="list-style-type: none"> <li>• Disconnect the power, then reconnect.</li> <li>• Press ON/OFF button on remote control to restart operation.</li> </ul>

**NOTE**



If problem persists, contact a local dealer or your nearest customer service center. Provide them with a detailed description of the unit malfunction as well as your model number.

## TROUBLESHOOTING

If trouble occurs, please check the following points before contacting a repair company.

PROBLEM	POSSIBLE CAUSES	SOLUTION
<b>Poor cooling performance</b>	Temperature setting may be higher than ambient room temperature.	Lower the temperature setting.
	The heat exchanger on the indoor or outdoor unit is dirty.	Clean the affected heat exchanger.
	The air filter is dirty.	Remove the filter and clean it according to instructions.
	The air inlet or outlet of either unit is blocked.	Turn the unit off, remove the obstruction and turn it back on.
	Doors and windows are open.	Make sure that all doors and windows are closed while operating the unit.
	Excessive heat is generated by sunlight.	Close windows and curtains during periods of high heat or bright sunshine.
	Low refrigerant due to leak or long-term use.	Check for leaks, re-seal if necessary and top off refrigerant.
	Too many sources of heat in the room (people, computers, electronics, etc.).	Reduce amount of heat sources.
<b>Poor heating performance</b>	The outdoor temperature is extremely low.	Use auxiliary heating device.
	Cold air is entering through doors and windows.	Make sure that all doors and windows are closed during use.
	Low refrigerant due to leak or long-term use.	Check for leaks, re-seal if necessary and top off refrigerant.
<b>The unit starts and stops frequently</b>	There's too much or too little refrigerant in the system.	Check for leaks and recharge the system with refrigerant.
	Incompressible gas or moisture has entered the system.	Evacuate and recharge the system with refrigerant.
	The compressor is broken.	Replace the compressor.
	The voltage is too high or too low.	Install a manostat to regulate the voltage.
<b>Indicator lamps continue flashing or error code appears</b>	<p>The unit may stop operation or continue to run safely. If the indicator lamps continue to flash or error codes appear, wait for about 10 minutes. The problem may resolve itself.</p> <p>If not, disconnect the power, then connect it again. Turn the unit on.</p> <p>If the problem persists, disconnect the power and contact your nearest customer service center.</p>	

<b>PROBLEM</b>	<b>POSSIBLE CAUSES</b>	<b>SOLUTION</b>
<b>The unit is not working</b>	Power failure	Wait for the power to be restored
	The power is turned off	Turn on the power
	The fuse is burned out	Replace the fuse
	Remote control batteries are dead	Replace the batteries
	The unit's 3-minute protection has been activated	Wait three minutes after restarting the unit
	Timer is activated	Turn timer off

**NOTE**

If your problem persists after performing the checks and diagnostics above, or an error code remains, turn off your unit immediately and contact an authorized service center.

**THIS PAGE INTENTIONALLY LEFT BLANK.**

## LIMITED WARRANTY – PARTS

### TEN (10) YEARS PARTS

Subject to all of the terms of this Limited Warranty, including, but not limited to, the specific exclusions set forth below and subject to the Manufacturer's right to inspect and validate the warranty claim as set forth below, Manufacturer will repair or replace, at its option, ANY PART of Covered Equipment that is found to be defective in materials or workmanship. If an exact replacement part is not available, an equivalent part or credit will be provided.

The parts are warranted for a period of ten (10) years to the original owner of the mini-split equipment under normal use and service. For a period of ten (10) years from the date of installation, if any parts prove defective due to improper workmanship and/or material, Durastar will replace any defective part without charge for the part. Replacement parts carry the balance of the original 10-year parts warranty.

To qualify:

- The mini-split equipment must be installed in a residential single-family home.\*
- The original mini-split equipment owner must reside in the single-family home.
- The mini-split equipment must be properly installed. This includes installation by a contractor licensed for HVAC installation following all local and state laws.
- Any part to be replaced must be made available in exchange for the replacement.

\*Single-family home is defined as any single-family dwelling, which includes apartments, condominiums, duplexes, and homes.

### EFFECTIVE DATE OF WARRANTY

The Effective Date of warranty coverage is determined as follows: (a) If the original installation date can be verified by the installer's invoice then the Effective Date of warranty coverage is the original installation date as shown on the installer's invoice. For residential new construction installations, the final occupancy permit, or proof of purchase from the builder can be substituted for the installer's invoice. (b) if the original installation date cannot be verified by the installer's invoice, or proof of purchase from the builder in residential new construction applications, then the Effective Date of warranty coverage is the Covered Equipment's manufacture date (as verified by the product's serial number) plus ninety (90) days.

There is NO LABOR component provided with this warranty. This Limited Warranty does NOT cover any labor costs or expenses for service, NOR for removing or reinstalling parts. You are responsible for all labor costs or expenses, unless a labor service agreement exists between you and your contractor.

This Limited Warranty does NOT cover shipping costs. You are responsible for the cost of shipping warranty replacement parts from our factory to the Manufacturer's distributor and from the distributor to the location of your Covered Equipment. You also are responsible for the cost of shipping failed parts to the distributor and for incidental costs incurred locally, including handling charges. (If in Alaska, Hawaii or Canada, you also must pay the shipping costs of returning the failed part to the port of entry into the continental United States.)

### EXCLUSIONS

In addition to the other exclusions identified in this Limited Warranty, this Limited Warranty excludes:

- Damages, malfunctions, or failures resulting from failure to properly install, operate, or maintain Covered Equipment in accordance with the Manufacturer's instructions.
- Damages, malfunctions, or failures resulting from misuse, accident, contaminated, or corrosive atmosphere, vandalism, freight damage, fire, flood, freeze, lightning, acts of war, acts of God and the like.
- Parts installed with Covered Equipment or used in connection with normal maintenance, such as cleaning or replacing air filters, refrigerant, thermostats, tubing, or concrete pads.
- Covered Equipment that is not installed in the United States.

- Covered Equipment that is not installed by a qualified, trained HVAC professional in accordance with applicable codes, ordinances, and good trade practices.
- Damages, malfunctions, or failures resulting from the use of any attachment, accessory, or component not authorized by the Manufacturer or resulting from alteration or modification of the unit.
- Covered Equipment moved from the original installation location.
- Covered Equipment when operated with system components (indoor unit, outdoor unit, coil, and refrigerant control devices) or accessories which do not match or meet the specifications recommended by the Manufacturer.
- Any Covered Equipment manufactured that has been sold to the consumer via the Internet or auction website, and has not been installed by a trained, qualified HVAC professional.
- Covered Equipment that is not part of a properly matched system as specified by the Air Conditioning, Heating & Refrigeration Institute (AHRI).

#### COMMERCIAL WARRANTY

Installations in commercial applications carry a ONE (1) YEAR PARTS warranty following the other provisions in this Limited Warranty.

#### OBTAINING WARRANTY SERVICE

If you believe your product is defective, contact the licensed contractor who installed your mini-split system. Alternatively, contact a licensed contractor, dealer, or distributor.

Durastar Customer Support is available for troubleshooting assistance. Before contacting Customer Support, please locate your model number, serial number, and proof of purchase. These items will be required to complete any warranty service. A Durastar authorized representative will verify warranty eligibility and determine appropriate service options. Service will be provided during normal business days and hours.

THIS WARRANTY IS IN LIEU OF ANY OTHER WARRANTY, EXPRESS OR IMPLIED, INCLUDING WITHOUT LIMITATION, ANY WARRANTY OF MERCHANTABILITY OR FITNESS FOR A PARTICULAR PURPOSE. TO THE EXTENT ANY IMPLIED WARRANTY IS REQUIRED BY LAW, IT IS LIMITED IN DURATION TO THE EXPRESS WARRANTY PERIOD ABOVE. NEITHER THE MANUFACTURER NOR ITS DISTRIBUTORS SHALL BE LIABLE FOR ANY INCIDENTAL, CONSEQUENTIAL, INDIRECT, SPECIAL, OR PUNITIVE DAMAGES OF ANY NATURE, INCLUDING WITHOUT LIMITATION, LOST REVENUES OR PROFITS, OR ANY OTHER DAMAGE WHETHER BASED IN CONTRACT, TORT, OR OTHERWISE. IN NO EVENT AND UNDER NO CIRCUMSTANCE OF ANY TYPE OR KIND SHALL THE SELLER, MANUFACTURER AND/OR DISTRIBUTOR BE LIABLE FOR ANY REASON, UNDER ANY THEORY, FOR MORE THAN THE BASIC COST OF THE PRODUCT TO THE PURCHASER OR END USER. SOME STATES DO NOT ALLOW THE EXCLUSION OF INCIDENTAL OR CONSEQUENTIAL DAMAGES, SO THE ABOVE EXCLUSION MAY NOT APPLY TO YOU. THIS WARRANTY GIVES YOU SPECIFIC LEGAL RIGHTS. YOU MAY HAVE OTHER RIGHTS THAT VARY FROM STATE TO STATE.





OWNER'S MANUAL

**WALL MOUNTED INDOOR UNIT  
SPLIT-STYLE AIR CONDITIONER**

DRAW06F1B, DRAW09F1B, DRAW12F1B,  
DRAW18F1B, DRAW24F1B

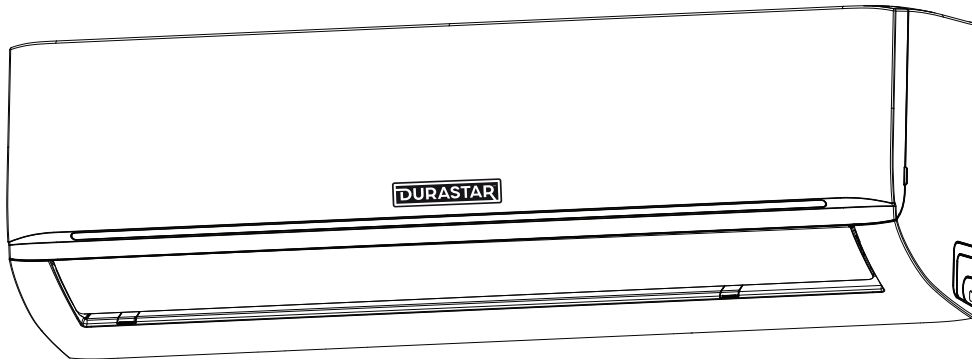

Model Number:

Serial Number:

Purchase Date:

Installing Contractor Company Name:



**TIP**

Capture relevant information about your Durastar mini-split equipment before it is installed and write it above for future reference.

## TABLE OF CONTENTS

TABLE OF CONTENTS .....	2
INTRODUCTION .....	3
WARNINGS .....	3
IMPORTANT SAFETY PRECAUTIONS.....	4
PARTS IDENTIFICATION .....	7
INCLUDED ACCESSORIES .....	8
OPERATING TEMPERATURES.....	9
REMOTE CONTROL.....	10
REMOTE CONTROL SCREEN INDICATORS .....	11
OPERATING MODES .....	12
ADVANCED BUTTONS AND FEATURES .....	13
LOUVERED AIR FLOW .....	17
LED DISPLAY INDICATORS.....	18
MANUAL OPERATION (USE WITHOUT REMOTE) .....	18
CARE AND MAINTENANCE .....	19
TROUBLESHOOTING.....	21
LIMITED WARRANTY - PARTS.....	26

## INTRODUCTION

To better serve you, please do the following before contacting customer service:

- If you received a damaged product, immediately contact the retailer or dealer that sold you the product.
- Read and follow this owner's manual carefully to help you use and maintain your air conditioner.
- Read the troubleshooting section of this manual as it will help you diagnose and solve common issues.
- Visit us on the web at [www.durastar.com](http://www.durastar.com) to download product guides and up-to-date information.
- If you need warranty service, our friendly customer service representatives are available via email at [questions@durastar.com](mailto:questions@durastar.com) or by telephone at 1-888-320-0706.

## WARNINGS

### Symbols Used in This Manual



The warning symbol indicates cautionary information for the user. Extra care and precautions should be taken to ensure the user's safety.



The pencil indicates any manufacturer notes relating to surrounding content. These may include further clarifications or call-outs.



A light bulb symbol indicates suggested manufacturer tips for the user to get the most out of the Durastar equipment and to accommodate the best user experience.

## IMPORTANT SAFETY PRECAUTIONS

Improper handling can cause serious damage or injury. Please read the following safety information in its entirety.



### **Operation, Cleaning, and Maintenance Safety Precautions**

- Children and people with reduced physical, sensory, or mental capabilities, or lack of experience and knowledge, should only use this air conditioner if they are given supervision or instructions concerning use of the air conditioner in a safe way and understand the hazards involved.
- Children should not play with the air conditioner.
- Never stick fingers or any other body parts into the air conditioner openings. The internal fan may be rotating at high speeds, and may result in injury.
- After removing the filter, do not touch the fins in order to avoid injury.
- Maintenance must be performed by qualified professionals. Otherwise, you may experience personal injury or damage to the air conditioner and surrounding property.
- Do not repair the air conditioner by yourself. It may cause electric shock or damage. Please contact a qualified service representative when you need to repair the air conditioner.
- Do not block the air outlet or air inlet. This could cause a malfunction.
- Do not spill water on the remote control as this can permanently damage the remote.
- If the below problems occur, please turn off the air conditioner and disconnect power at the circuit breaker immediately. Then contact your dealer or a qualified professional for service.
  - The power cord is overheating or damaged.
  - There is an abnormal sound during operation.
  - The circuit breaker trips frequently.
  - The air conditioner gives off a burning smell.
  - The indoor unit is leaking.
- If the air conditioner operates under abnormal conditions, it may cause malfunctions, electric shock, or fire hazard.
- When turning the unit on or off via the emergency operation switch, press the switch with an insulated object other than metal.
- Do not step on the top panel of the unit, or put heavy objects on the top panel. This could cause damage or personal injury.
- Cleaning and user maintenance should not be performed by children without supervision.
- Do not spray water on the indoor unit. This could cause electric shock or a unit malfunction.
- Do not use flammable materials such as hair spray, lacquer, or paint near the air conditioner as they may catch fire.
- Do not operate the air conditioner in places near combustible gases. Emitted gases may collect around the air conditioner and cause an explosion.
- Do not use fire or a hair dryer to dry the filter. This could cause a deformation or fire hazard.
- Do not wash the air conditioner with water as this could cause an electric shock.
- Disconnect the power supply by turning it off at the circuit breaker when cleaning the air conditioner. Otherwise, you could risk electric shock.



## **Electrical Safety**

- Do not modify the length of the power supply cord or use an extension cord to power the unit.
- If the supply cord is damaged, it must be replaced by the manufacturer, a service agent, or a similarly qualified person in order to avoid a safety hazard.
- Do not share the electrical outlet with other appliances. Improper or insufficient power supply can cause fire or electrical shock.
- The product must be properly grounded at the time of installation, or electrical shock may occur.
- For all electrical work, follow all local and national wiring standards and regulations. Connect cables tightly, and clamp them securely to prevent external forces from damaging the terminal. Improper electrical connections can overheat and cause fire, and may also cause shock. All electrical connections must be made according to the Electrical Connection Diagram located on the panels of the indoor and outdoor units.
- All wiring must be properly arranged to ensure that the control board cover can close properly. If the control board cover is not closed properly, it can lead to corrosion and cause the connection points on the terminal to heat up, catch fire, or cause electrical shock.
- The air conditioner's circuit board (PCB) is designed with a fuse to provide overcurrent protection. The specifications of the fuse are printed on the circuit board.



### **Installation Safety**

- Installation must be performed by an authorized dealer or specialist. Improper installation can cause water leakage, electrical shock, or fire. (In North America, installation must be performed in accordance with NEC and CEC requirements by authorized personnel only.)
- Installation must be performed according to the installation instructions. Improper installation can cause water leakage, electrical shock, or fire.
- This air conditioner shall be installed in accordance with national and local wiring regulations.
- Contact an authorized service technician for repair or maintenance of this unit.
- Only use the included accessories, parts, and specified parts for installation. Using non-standard parts can cause water leakage, electrical shock, fire, and can cause the unit to fail.
- Install the unit in a firm location that can support the unit's weight. If the chosen location cannot support the unit's weight, or the installation is not done properly, the unit may fall and cause serious injury and damage.
- Install drainage piping according to the instructions in the installation manual. Improper drainage may cause water damage to your home and property.
- Do not install the unit in a location that may be exposed to combustible gas leaks. If combustible gas accumulates around the unit, it may cause a fire.
- Do not turn on the power until all work has been completed.
- When moving or relocating the air conditioner, consult experienced service technicians for disconnection and re-installation of the unit.



### **Additional Precautions**

- Turn off the air conditioner and disconnect the power if you are not going to use it for a long time.
- Turn off the unit during electrical storms to avoid damaging the unit.
- Make sure that water condensation can drain unhindered from the unit.
- Do not operate the air conditioner with wet hands. This may cause electric shock.
- Do not use this device for any other purpose than its intended use.
- Do not climb onto or place objects on top of the outdoor unit.
- Do not allow the air conditioner to operate for long periods of time with doors or windows open, or if the humidity is very high.

# PARTS IDENTIFICATION

## INDOOR UNIT

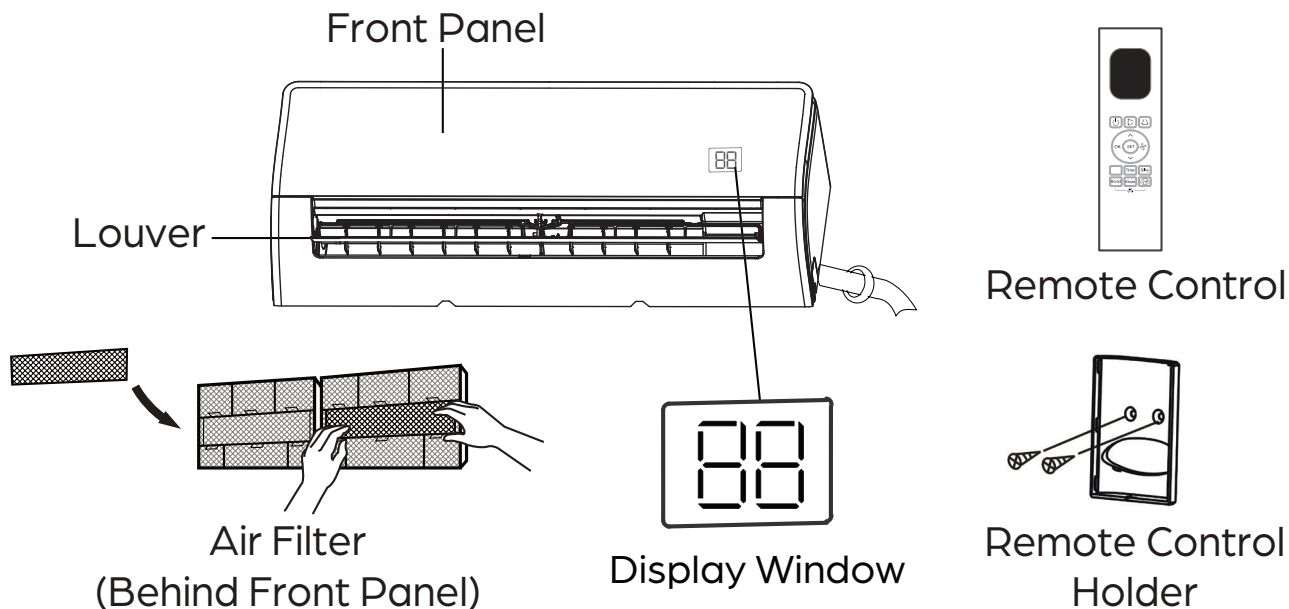

## OUTDOOR UNIT

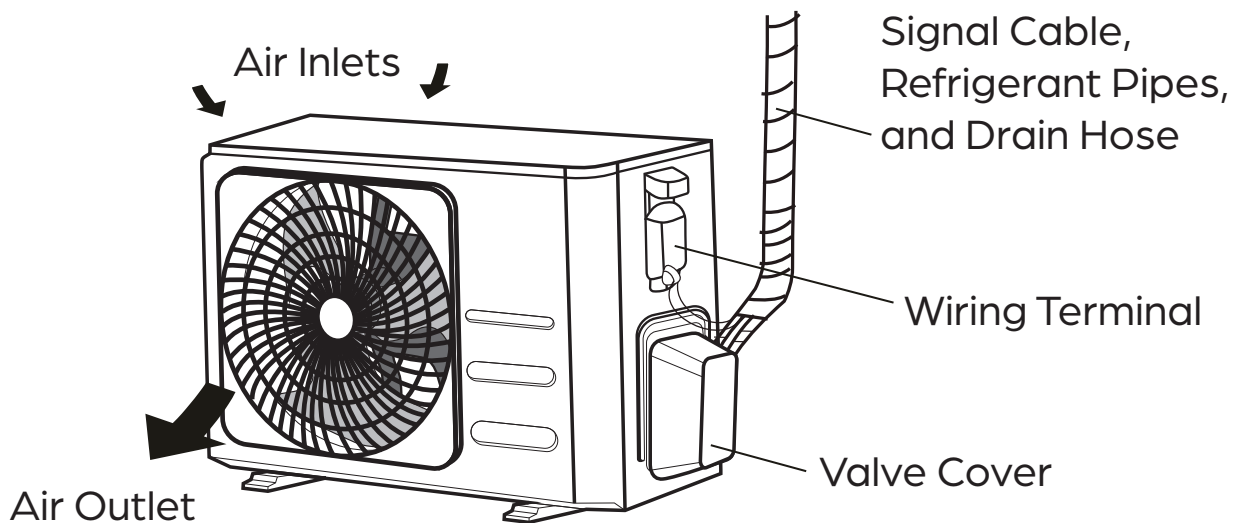









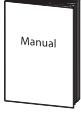

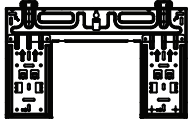
**NOTE**

Outdoor units will vary in appearance.

## INCLUDED ACCESSORIES

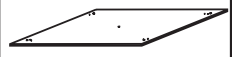
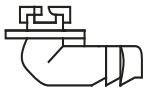
The air conditioning system comes with the following accessories.

Accessory	Quantity	Image	Accessory	Quantity	Image
Manual	1-2		Remote Control	1	
Mounting Plate	1		Battery	2	
Wall Anchor	5-8 (depending on model)		Remote Control Holder	1	
Mounting Plate Screw	5-8 (depending on model)		Remote Control Holder Mounting Screw	2	
Copper Nut	2		Installation Template	1	
Drain Joint	1		Carbon Filter	2	
Drain Joint Seal	1				



# OPERATING TEMPERATURES

Your air conditioner is designed to operate in the following indoor and outdoor temperatures. When your air conditioner is used outside of the following temperature ranges, certain safety features may activate and turn off the unit to protect it from damage.

## TEMPERATURE RANGES

	<b>COOL Mode</b>	<b>HEAT Mode</b>	<b>DRY Mode</b>
<b>Indoor Air Temperature</b>	60°F – 90°F (16°C – 32°C)	32°F – 86°F (0°C – 30°C)	50°F – 90°F (10°C – 32°C)
<b>Outdoor Air Temperature</b>	5°F – 122°F (–15°C – 50°C)	–13°F – 75°F* (–25°C – 24°C)*	32°F – 122°F (0°C – 50°C)

\* The minimum operating temperature depends on the outdoor unit. Low ambient models have a minimum operating temperature in heat mode of –22°F (–30°C).

To further optimize the performance of your unit, do the following:

- Keep doors and windows closed.
- Limit energy usage by using TIMER ON and TIMER OFF features.
- Do not block air inlets or outlets.
- Regularly inspect and clean air filters.

### NOTE



Your Durastar heat pump's outdoor unit is equipped with a base pan heater, allowing it to continue to operate at freezing temperatures as low as –22°F (–30°C). When outdoor air temperatures are at or below 32°F (0°C), we strongly recommend keeping the unit plugged in at all times to ensure smooth, ongoing performance.

### NOTE



Keep the room's relative humidity below 80%. If the air conditioner operates in excess of this, the surface of the air conditioner may attract condensation. To help prevent condensation from forming and dripping, set the vertical airflow louver to its maximum angle (vertically to the floor) and set the fan to HIGH.

## REMOTE CONTROL

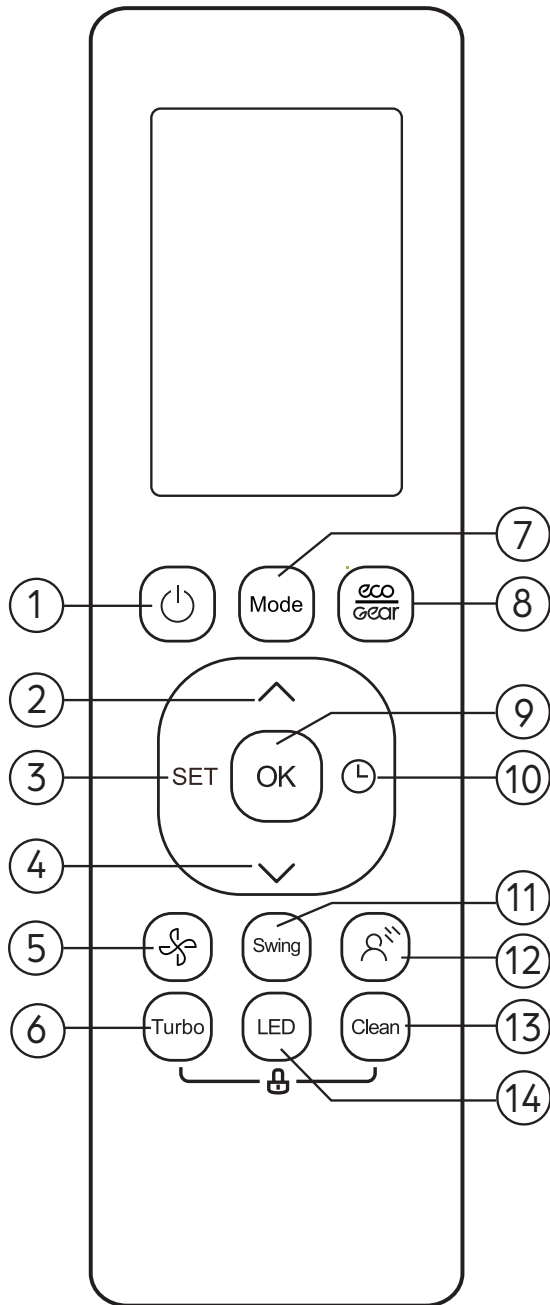

**1. ON/OFF Button**

Turns the air conditioner ON and OFF.

**2. UP Button (▲)**

Press to increase the set temperature in 1°F / 1°C increments .

**3. SET Button**

Press to access the SET features menu. See "Advanced Buttons and Features" section.

**4. DOWN Button (▼)**

Press to decrease the set temperature in 1°F / 1°C increments. Press (▲) and (▼) at the same time for 3 seconds to switch between °F and °C.

**5. FAN Button**

Press to select FAN speed.

**6. TURBO Button**

Press to turn on and off the TURBO feature. See "Advanced Buttons and Features" section.

**7. MODE Button**

Press to adjust the air conditioner MODE in the following sequence: → AUTO → COOL → DRY → HEAT → FAN →

**8. ECO/GEAR Button**

Press to enter one of three energy efficiency modes. See "Advanced Buttons and Features" section.

**9. OK Button**

Press to confirm selected functions.

**10. TIMER Button**

Press to initiate the TIMER feature. See "Advanced Buttons and Features" section.

**11. SWING Button**

Press to start and stop the automatic horizontal louver movement or set a fixed louver angle.

**12. GENTLE Button**

Press to stop the air flow from blowing directly on you if it becomes uncomfortable. See "Advanced Buttons and Features" section.

**13. CLEAN Button**

Turns on and off the CLEAN feature. See "Advanced Buttons and Features" section.

**14. LED Button**

Press to turn on and off the indoor unit's display screen.

# REMOTE CONTROL SCREEN INDICATORS

## Transmission Indicator

Lights up when remote sends signal to indoor unit.



**TIMER ON** display



**TIMER OFF** display



**SILENCE** feature display

## FAN SPEED display

Displays selected fan speed:

Silence		1%
		2%-20%
LOW		21%-40%
MED		41%-60%
		61%-80%
HIGH		81%-100%
AUTO		

The fan speed cannot be adjusted in AUTO or DRY mode.

Note:

Not all the models can display the fan speed values between AUTO-100%.

- GENTLE** feature display
- CLEAN** feature display
- SLEEP** feature display
- FOLLOW ME** feature display
- Network display (not available for this unit)
- Low battery display (If flashing)

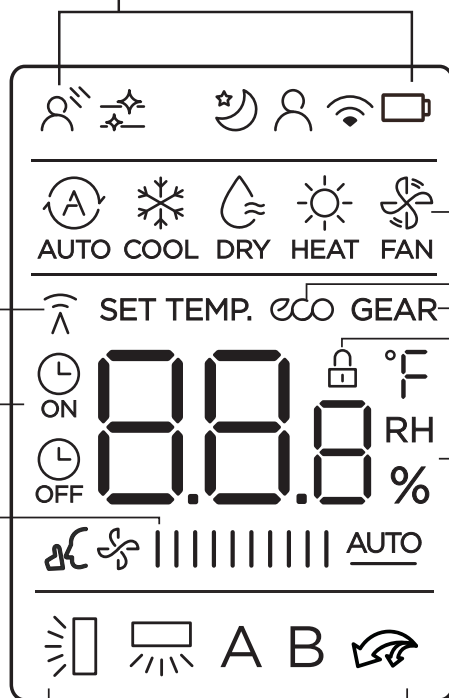

## MODE display

Displays the current mode, including:



## ECO display

Displays when ECO feature is activated.

## GEAR display

Displays when GEAR feature is activated.

## LOCK display

Displays when LOCK feature is activated.

Temperature/Timer/  
Fan Speed % display  
Displays the set temperature unless the fan speed or timer setting functions are in use.

## TIMER ON/OFF functions.

- Temperature range: 60-86°F (16-30°C)
- Timer setting range: 0-24 hours
- Fan speed setting range: AUTO -100%

This display is blank when operating in **FAN** mode.

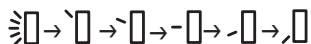

**Horizontal** louver swing display



**Vertical** louver swing (not available on unit)



**TURBO** feature display



A Not available for this unit



B Not available for this unit





## NOTE

All indicators shown in the above figure are for purposes of clear representation. During actual operation, only the relative indicators are illuminated in the display window.

## OPERATING MODES ( )

### SETTING TEMPERATURE

This unit can be set at any temperature within its operating range in AUTO, COOL, HEAT, and DRY modes (see "Temperature Ranges" section). You can increase or decrease the set temperature in 1°F (1°C) increments by pressing the UP (  ) or DOWN (  ) button.

### AUTO ( )

In AUTO mode, the unit will automatically select the COOL, FAN, HEAT, or DRY modes to maintain the set temperature. In AUTO mode, the fan speed cannot be set.

1. Select AUTO mode
2. Set desired temperature
3. Turn on air conditioner

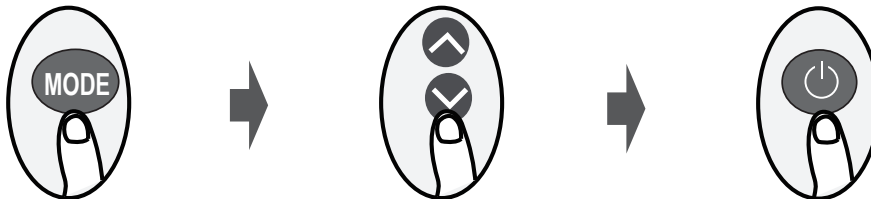

### COOL or HEAT ( or )

1. Select COOL or HEAT mode
2. Set desired temperature
3. Set fan speed
4. Turn on air conditioner

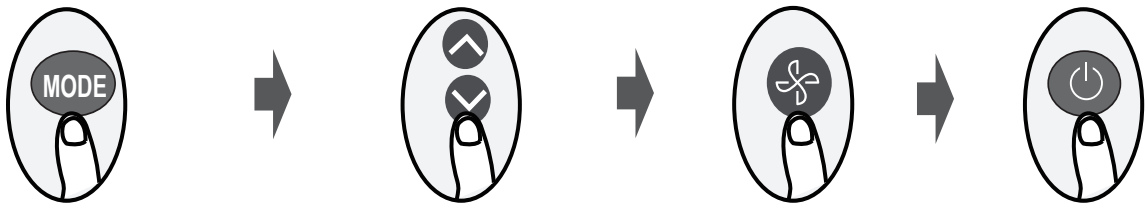

### DRY/DEHUMIDIFY ( )

In DRY mode, the fan runs continuously on low speed. The unit will operate continuously until it reaches 50°F (10°C), at which time it will turn off. DRY mode operation will then resume once the room temperature reaches 54°F (12°C).

1. Select DRY mode
2. Set any temperature
3. Turn on air conditioner

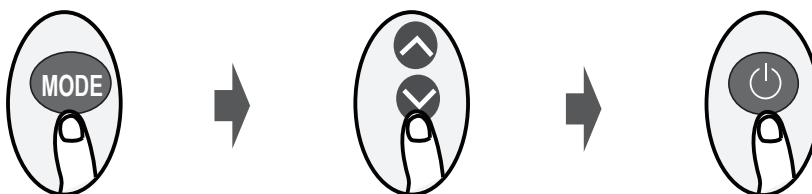

#### NOTE

\*For this series of mini-splits, changing the temperature in DRY mode does not deviate performance from the above mode description.



#### NOTE

The FAN speed cannot be adjusted in AUTO or DRY Mode.



#### NOTE

Press and hold the UP and DOWN buttons simultaneously for 3 seconds to switch between °F and °C.

## FAN ( )

In FAN mode, the temperature cannot be set and no temperature will be displayed on the remote screen.

1. Select FAN mode

2. Set fan speed

3. Turn on air conditioner



### NOTE

You cannot adjust the temperature in FAN mode. As a result, your remote control's LCD display will not display a temperature.



### NOTE

As outdoor temperature drops, the performance of your unit's HEAT function may be affected.



### NOTE

Two or more indoor units can be operated by one outdoor unit. However, two or more indoor units cannot operate simultaneously when different operating modes have been selected. If COOL/DRY/FAN is selected with one or more indoor units and HEAT with another, the unit(s) in HEAT has priority.

## ADVANCED BUTTONS AND FEATURES

### ECO/GEAR ( )

The ECO/GEAR feature provides three levels of energy saving options. ECO/GEAR is only available in COOL mode. Some of these options may result in insufficient cooling in circumstances of high ambient heat. The ECO/GEAR feature is not available in multiple zone configurations.

#### ECO ( *eco* )

While the unit is in COOL mode, press the ECO/GEAR button once. If the set temperature is above 75°F (24°C) the FAN speed will be set to AUTO. If the set temperature is below 75°F (24°C) it will automatically be adjusted to 75°F (24°C) and the FAN speed will be set to AUTO. When functioning in this mode, the unit can reduce its energy consumption up to 10%. Press the ECO/GEAR button to turn off this feature.

#### GEAR ( GEAR )

GEAR has two levels – 25% and 50% energy consumption. While the unit is in COOL mode, press the ECO/GEAR button twice (x2) within two (2) seconds to select 25% or three times (x3) to select 50%. If the set temperature is above 75°F (24°C) the FAN speed will be set to AUTO. If the set temperature is below 75°F (24°C) it will automatically be adjusted to 75°F (24°C) and the FAN speed will be set to AUTO. When functioning in these modes, the unit can reduce its energy consumption up to 25% or 50%. Press the ECO/GEAR button to turn off this feature.



### NOTE

The overall energy consumption of the unit is affected by many factors and this feature's energy reduction level setting will not result in directly proportional money savings on your energy bill.

## SET BUTTON FEATURES ( SET )

Press the SET button to open the feature menu at the top of the display. Next, press SET or UP (▲) and DOWN (▼) to highlight the desired feature's icon. Finally, press OK to activate it.

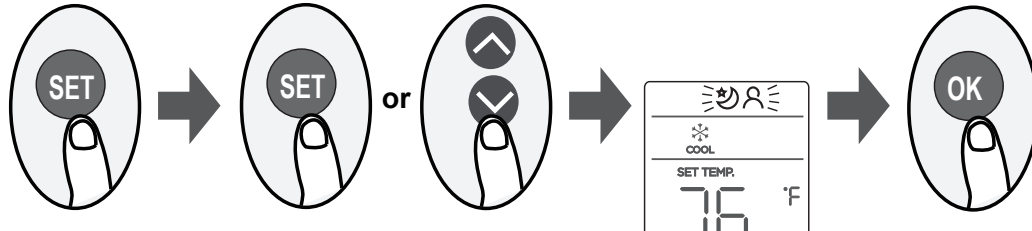

## SLEEP (☾)

The SLEEP feature is designed to decrease energy use while you sleep. The SLEEP feature is not available in FAN or DRY mode.

When you are ready to go to sleep, press the SET button, select the SLEEP icon and press OK. When in COOL mode, the unit will increase the temperature by 2°F (1°C) after one hour, and will increase an additional 2°F (1°C) after another hour. When in HEAT mode, the unit will decrease the temperature by 2°F (1°C) after one hour, and will decrease an additional 2°F (1°C) after another hour.

The SLEEP feature will turn off after eight hours and the system will return to normal functioning.

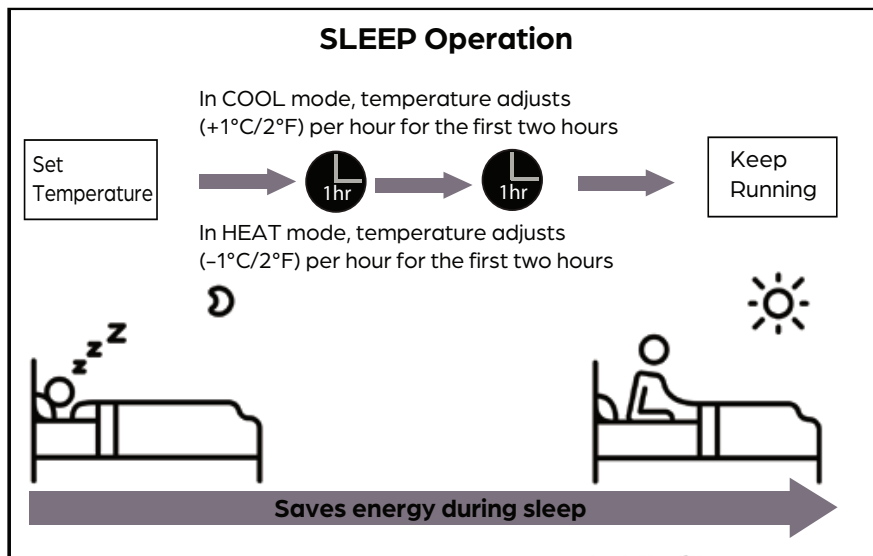

## FOLLOW ME (👤)

This feature uses the temperature at the remote's location, instead of the indoor unit's location, to optimize the temperature around you and ensure maximum comfort. To activate the FOLLOW ME feature, press the SET button, select the FOLLOW ME icon and press OK. To deactivate FOLLOW ME press ON/OFF or change the MODE.

To lock the FOLLOW ME feature, press and hold the TURBO button for seven (7) seconds. The remote will display "ON" for three (3) seconds and the temperature at its location. When using AUTO, COOL, and HEAT modes the air conditioner will continue running until the temperature at the remote's location is satisfied. Power failures, pressing ON/OFF or changing MODES will no longer cancel the feature. Press and hold the TURBO button again for seven (7) seconds to unlock and turn off this feature. The remote will display "OF" for three (3) seconds.

## NETWORK SETUP (📶)

This feature is not available on this unit.

**TIMER (🕒)**

The TIMER feature establishes the amount of time that will elapse before the unit will automatically turn on/off.

1. Press TIMER button to initiate the time ON sequence.
2. Press UP or DOWN button the required number of times to set the desired time to turn on the unit.
3. Point remote at unit for 1 second. The TIMER ON will be activated.

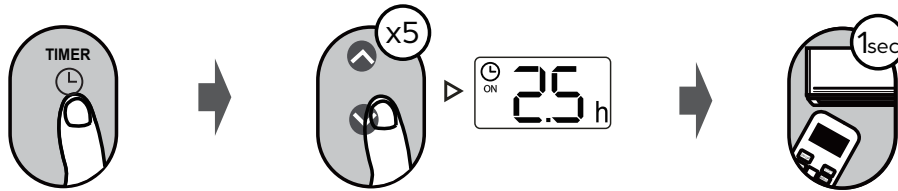

1. Press TIMER button to initiate the time OFF sequence.
2. Press UP or DOWN button the required number of times to set the desired time to turn on the unit.
3. Point remote at unit for 1 second. The TIMER OFF will be activated.

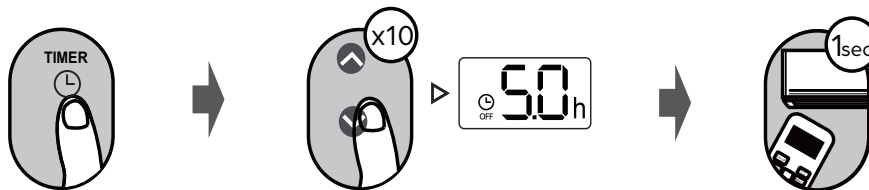

**TIMER ON and OFF setting example.**

Keep in mind that the time periods you set for both the on and off feature refers to hours after the current time.

If the current time is 1:00 PM and the TIMER ON setting is adjusted to 2.5 hours, the auto-on time sequence will turn the air conditioner on 2.5 hours later at 3:30 PM. Setting the TIMER OFF auto-off sequence to 5.0 hours will turn off the air conditioner 5 hours later at 6:00 PM.

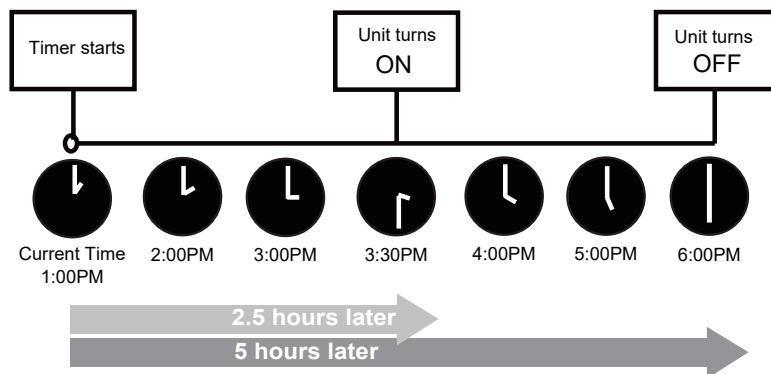

**GENTLE (🌀)**

If the air flow from the unit becomes uncomfortable because it is too intense or blowing directly on you, simply press the GENTLE button to slow the unit and divert the air flow away from you. Press the GENTLE button again to turn this feature off. This feature is only available under COOL, DRY, and FAN modes. This feature is not available in multiple zone configurations.

## TURBO ( Turbo )

Press the TURBO button to turn this feature on and off. The TURBO feature enables the unit to reach the set temperature in the shortest time by automatically controlling the fan speed. This feature is only available in COOL and HEAT modes.

## LED ( LED )

Press the LED button to turn on and off the display of the indoor unit.

## CLEAN ( Clean )

Airborne bacteria can grow in the moisture that condenses around the heat exchanger in the unit. With regular use, most of this moisture is evaporated from the unit. By pressing the CLEAN button, your unit will clean itself automatically. After cleaning, the unit will turn off automatically. Pressing the CLEAN button mid-cycle will cancel the operation and turn off the unit. You can use CLEAN as often as you like. You can only activate the CLEAN function in COOL or DRY modes. This feature is not available in multiple zone configurations.

## SILENCE ( )

Press the FAN button for two (2) seconds to turn on and off the SILENCE feature. When the SILENCE feature is activated, the compressor will slow and the indoor unit will turn the fan to low. This will reduce the noise of the indoor unit to the lowest level. Due to the slow operation of the compressor, it may result in insufficient cooling and heating capacity. This feature is not available in multiple zone configurations.

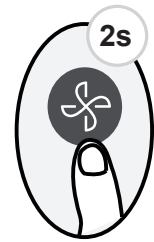

## FREEZE PROTECTION (FP)

The FREEZE PROTECTION feature sets the indoor temperature to 46°F (8°C). The unit will maintain this temperature and prevent indoor pipes and household items from freezing when the house is unoccupied for long periods of time in the winter. The display will show "FP" when this feature is on.

To activate, first turn the unit to HEAT mode and set the temperature to 60°F (16°C). Then, press the DOWN ( ▼ ) button twice (x2) in one (1) second to start the FREEZE PROTECTION feature. Press the ON/OFF button to turn off the feature. This feature is only available in HEAT mode.

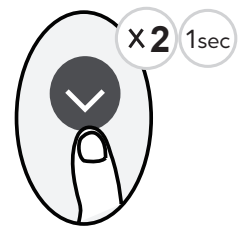

## LOCK ( )

The LOCK feature disables the remote's buttons so your settings cannot be changed. To activate the remote LOCK feature, simultaneously press the CLEAN and TURBO buttons for five (5) seconds. To turn off the LOCK feature, simultaneously press CLEAN and TURBO again for five (5) seconds.

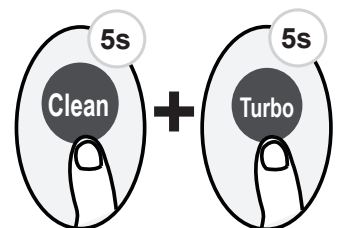

## AUTO-RESTART

The AUTO-RESTART feature is enabled when power is interrupted to the unit. After power is restored, the unit will automatically return to its prior settings before power was lost. No buttons need to be pressed to set this feature – it is automatic.



## REFRIGERANT LEAK DETECTION (EC)

The indoor unit will automatically display "EC" when it detects a refrigerant leak. If a leak is detected, turn off your unit and contact your dealer or certified technician for service.

## LOUVERED AIR FLOW

### SETTING VERTICAL ANGLE ( )

While the unit is on, press the SWING button on the remote control to set the vertical direction of airflow.

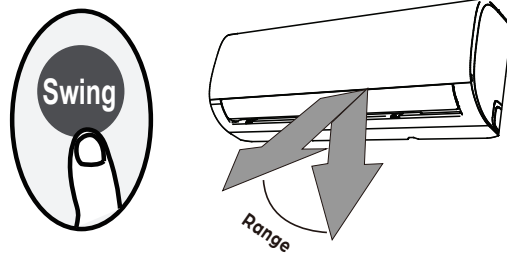

### AUTOMATIC SWING ( )

Press the SWING button once to start the automatic vertical (up and down) movement of the louver. Press again to make it stop.

### FIXED LOUVER ANGLE ( )

Quickly press the SWING button 2-6 times to adjust the fixed angle of the louver. Each press will adjust the louver by 6°. Press the button until the desired angle is reached. The remote will display the selected angle.



#### NOTE

Do not move louver by hand. This will cause the louver to become out of sync. If this occurs, turn off the unit and shut off the breaker for 30 seconds, then restart the unit. This will reset the louver.

## SETTING HORIZONTAL ANGLE

The horizontal angle of the airflow must be set manually. Grip the deflector rod and manually adjust it to your preferred direction.

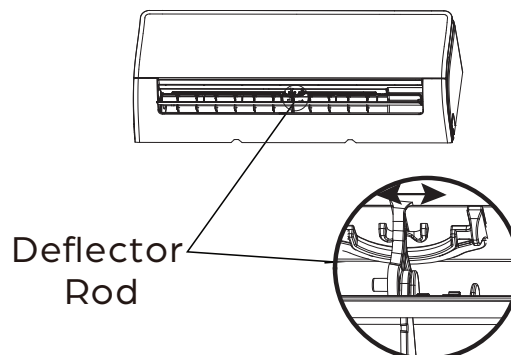

#### CAUTION

Do not put your fingers in or near the blower and suction side of the unit. The high-speed fan inside the unit may cause injury.

## LED DISPLAY INDICATORS

The following is a list of possible indicators that may appear on the indoor unit's display. Not all the display indicators may be available on the unit purchased.

Feature	Indicator	Notes
TIMER ON, SWING, TURBO, SILENCE	ON	Displays for 3 seconds when the TIMER ON feature is set or the SWING, TURBO, or SILENCE feature is turned on. If the unit is off, ON will continue to be shown if the TIMER ON feature is set.
TIMER OFF, SWING, TURBO, SILENCE	OF	Displays for 3 seconds when the TIMER OFF feature is set or the SWING, TURBO, or SILENCE feature is turned off.
CLEAN	CL	Displays when the CLEAN feature is on.
FREEZE PROTECTION	FP	Displays when the FREEZE PROTECTION feature is on.
FORCED COOLING	FC	Displays when the FORCED COOLING mode is selected with the manual control button. See Manual Operation section.
ANTI-COLD AIR FLOW	cF	The unit is designed not to blow cold air in HEAT mode. When HEAT mode is selected the unit will display "cF" until the set temperature is reached and the unit can blow warm air.
DEFROST	dF	Displays when unit is defrosting. This may last 5-10 minutes depending on the outdoor temperature and the amount of frost buildup on the outside unit.
REFRIGERANT LEAK	EC	Displays if a refrigerant leak is detected. Turn off your unit and contact your dealer or certified technician for service.

## MANUAL OPERATION (USE WITHOUT REMOTE)

The manual override button is intended for testing purposes and emergency operation. Please do not use this button unless the remote control is lost and it is absolutely necessary. The unit must be turned off before manual operation.

To operate your unit manually:

1. Open the front panel of the indoor unit.
2. Locate the MANUAL CONTROL button on the right-hand side of the unit.
3. Press the MANUAL CONTROL button one time to activate FORCED AUTO mode.
4. Press the MANUAL CONTROL button again to activate FORCED COOLING mode.
5. Press the MANUAL CONTROL button a third time to turn the unit off.
6. Close the front panel.

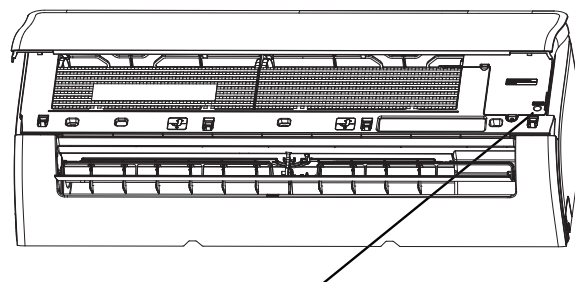

Manual Control  
Button

## CARE AND MAINTENANCE



### CAUTION

- Always turn off the unit and disconnect power before cleaning or maintenance.
- Only use a soft, dry cloth to wipe the unit clean. If the unit is especially dirty, you can use a cloth soaked in warm water to wipe it clean.

### CLEANING INDOOR UNIT

- Do not use chemicals or chemically treated cloths to clean the unit.
- Do not use benzene, paint thinner, polishing powder or other solvents to clean the unit. They can cause the plastic surface to crack or deform.
- Do not use water hotter than 104°F (40°C) to clean the front panel. This can cause the panel to deform or become discolored.

### CLEANING THE AIR FILTER

A dirty air filter can reduce the cooling efficiency of your unit, and can also be bad for your health. Make sure to clean the filter once every two weeks.

1. Lift the front panel of the indoor unit.
2. Grip the tab on the end of the filter, lift it up, then pull it towards yourself.
3. Now pull the filter out.
4. If your filter has a small air freshening filter, unclip it from the larger filter. Clean this air freshening filter with a hand-held vacuum.
5. Clean the large air filter with warm, soapy water. Be sure to use a mild detergent.
6. Rinse the filter with fresh water, then shake off excess water.
7. Dry filter in a cool, dry place, and refrain from exposing it to direct sunlight.
8. When dry, re-clip the air freshening filter to the larger filter, then slide it back into the indoor unit.
9. Close the front panel of the indoor unit.

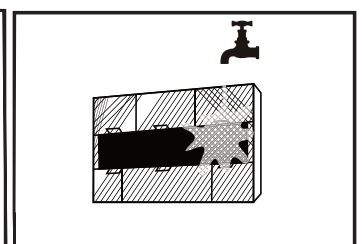
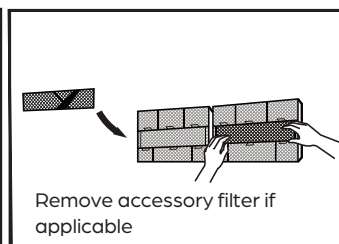
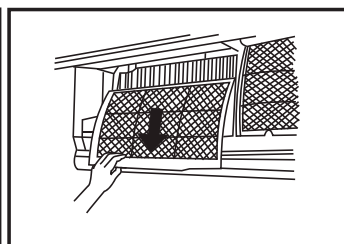
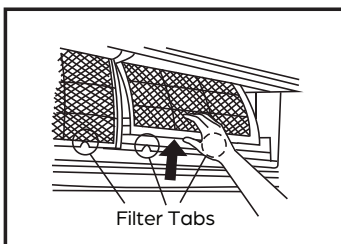

### CAUTION



- Before changing the filter or cleaning, turn off the unit and disconnect its power supply.
- When removing the filter, do not touch the metal parts in the unit. The sharp metal edges can cut you.
- Do not use water to clean the inside of the indoor unit. This can destroy insulation and cause electrical shock.
- Do not expose filter to direct sunlight when drying. This can shrink the filter.

**MAINTENANCE: LONG PERIODS OF NON-USE**

If you do not plan to use your air conditioner for an extended period of time, do the following:

- Clean all filters.
- Turn on the FAN until the unit dries out completely.
- Turn off the unit and disconnect the power.
- Remove batteries from remote control.

**MAINTENANCE: PRE-SEASON INSPECTION**

After long periods of non-use, or before periods of frequent use, do the following:

- Inspect for damaged wires.
- Clean all filters.
- Check for leaks.
- Replace batteries.
- Make sure nothing is blocking any air inlets or outlets.

# TROUBLESHOOTING

## SAFETY PRECAUTIONS

If ANY of the following conditions occur, turn off your unit immediately!

- The power cord is damaged or abnormally warm
- You smell a burning odor
- The unit emits loud or abnormal sounds
- A power fuse blows or the circuit breaker frequently trips
- Water or other objects fall into or out of the unit

**DO NOT ATTEMPT TO FIX THESE YOURSELF! CONTACT AN AUTHORIZED SERVICE PROVIDER IMMEDIATELY!**

## COMMON ISSUES

The following problems are not malfunctions and in most situations do not require repairs.

ISSUE	POSSIBLE CAUSES
<b>Unit does not turn on when pressing ON/OFF button</b>	The unit has a 3-minute protection feature that prevents the unit from overloading. The unit cannot be restarted within three minutes of being turned off.
<b>The unit changes from COOL/HEAT mode to FAN mode</b>	The unit may change its setting to prevent frost from forming on the unit. Once the temperature increases, the unit will start operating in the previously selected mode again.
	The set temperature has been reached, at which point the unit turns off the compressor. The unit will continue operating when the temperature fluctuates again.
<b>The indoor unit emits white mist</b>	In humid regions, a large temperature difference between the room's air and the conditioned air can cause white mist.
<b>Both the indoor and outdoor units emit white mist</b>	When the unit restarts in HEAT mode after defrosting, white mist may be emitted due to moisture generated during the defrosting process.
<b>The indoor unit makes noises</b>	A rushing air sound may occur when the louver resets its position.
	A squeaking sound may occur after running the unit in HEAT mode due to expansion and contraction of the unit's plastic parts.

ISSUE	POSSIBLE CAUSES
<b>Both the indoor unit and outdoor unit make noises</b>	Low hissing sound during operation: This is normal and is caused by refrigerant gas flowing through both indoor and outdoor units.
	Low hissing sound when the system starts, has just stopped running, or is defrosting: This noise is normal and is caused by the refrigerant gas stopping or changing direction.
	Squeaking sound: Normal expansion and contraction of plastic and metal parts caused by temperature changes during operation can cause squeaking noises.
<b>The outdoor unit makes noises</b>	The unit will make different sounds based on its current operating mode.
<b>Dust is emitted from either the indoor or outdoor unit</b>	The unit may accumulate dust during extended periods of non-use, which will be emitted when the unit is turned on. This can be mitigated by covering the unit during long periods of inactivity.
<b>The unit emits a bad odor</b>	The unit may absorb odors from the environment (such as furniture, cooking, cigarettes, etc.) which will be emitted during operations.
	The unit's filters have become moldy and should be cleaned.
<b>The fan of the outdoor unit does not operate</b>	During operation, the fan speed is controlled to optimize product operation.
<b>Operation is erratic, unpredictable, or unit is unresponsive</b>	Interference from cell phone towers and remote boosters may cause the unit to malfunction. In this case, try the following: <ul style="list-style-type: none"> <li>• Disconnect the power, then reconnect.</li> <li>• Press ON/OFF button on remote control to restart operation.</li> </ul>

**NOTE**



If problem persists, contact a local dealer or your nearest customer service center. Provide them with a detailed description of the unit malfunction as well as your model number.

## TROUBLESHOOTING

If trouble occurs, please check the following points before contacting a repair company.

PROBLEM	POSSIBLE CAUSES	SOLUTION
<b>Poor cooling performance</b>	Temperature setting may be higher than ambient room temperature.	Lower the temperature setting.
	The heat exchanger on the indoor or outdoor unit is dirty.	Clean the affected heat exchanger.
	The air filter is dirty.	Remove the filter and clean it according to instructions.
	The air inlet or outlet of either unit is blocked.	Turn the unit off, remove the obstruction and turn it back on.
	Doors and windows are open.	Make sure that all doors and windows are closed while operating the unit.
	Excessive heat is generated by sunlight.	Close windows and curtains during periods of high heat or bright sunshine.
	Low refrigerant due to leak or long-term use.	Check for leaks, re-seal if necessary and top off refrigerant.
	Too many sources of heat in the room (people, computers, electronics, etc.).	Reduce amount of heat sources.
<b>Poor heating performance</b>	The outdoor temperature is extremely low.	Use auxiliary heating device.
	Cold air is entering through doors and windows.	Make sure that all doors and windows are closed during use.
	Low refrigerant due to leak or long-term use.	Check for leaks, re-seal if necessary and top off refrigerant.
<b>The unit starts and stops frequently</b>	There's too much or too little refrigerant in the system.	Check for leaks and recharge the system with refrigerant.
	Incompressible gas or moisture has entered the system.	Evacuate and recharge the system with refrigerant.
	The compressor is broken.	Replace the compressor.
	The voltage is too high or too low.	Install a manostat to regulate the voltage.
<b>Indicator lamps continue flashing or error code appears</b>	<p>The unit may stop operation or continue to run safely. If the indicator lamps continue to flash or error codes appear, wait for about 10 minutes. The problem may resolve itself.</p> <p>If not, disconnect the power, then connect it again. Turn the unit on.</p> <p>If the problem persists, disconnect the power and contact your nearest customer service center.</p>	

<b>PROBLEM</b>	<b>POSSIBLE CAUSES</b>	<b>SOLUTION</b>
<b>The unit is not working</b>	Power failure	Wait for the power to be restored
	The power is turned off	Turn on the power
	The fuse is burned out	Replace the fuse
	Remote control batteries are dead	Replace the batteries
	The unit's 3-minute protection has been activated	Wait three minutes after restarting the unit
	Timer is activated	Turn timer off

**NOTE**

If your problem persists after performing the checks and diagnostics above, or an error code remains, turn off your unit immediately and contact an authorized service center.



**THIS PAGE INTENTIONALLY LEFT BLANK.**

## LIMITED WARRANTY – PARTS

### TEN (10) YEARS PARTS

Subject to all of the terms of this Limited Warranty, including, but not limited to, the specific exclusions set forth below and subject to the Manufacturer's right to inspect and validate the warranty claim as set forth below, Manufacturer will repair or replace, at its option, ANY PART of Covered Equipment that is found to be defective in materials or workmanship. If an exact replacement part is not available, an equivalent part or credit will be provided.

The parts are warranted for a period of ten (10) years to the original owner of the mini-split equipment under normal use and service. For a period of ten (10) years from the date of installation, if any parts prove defective due to improper workmanship and/or material, Durastar will replace any defective part without charge for the part. Replacement parts carry the balance of the original 10-year parts warranty.

To qualify:

- The mini-split equipment must be installed in a residential single-family home.\*
- The original mini-split equipment owner must reside in the single-family home.
- The mini-split equipment must be properly installed. This includes installation by a contractor licensed for HVAC installation following all local and state laws.
- Any part to be replaced must be made available in exchange for the replacement.

\*Single-family home is defined as any single-family dwelling, which includes apartments, condominiums, duplexes, and homes.

### EFFECTIVE DATE OF WARRANTY

The Effective Date of warranty coverage is determined as follows: (a) If the original installation date can be verified by the installer's invoice then the Effective Date of warranty coverage is the original installation date as shown on the installer's invoice. For residential new construction installations, the final occupancy permit, or proof of purchase from the builder can be substituted for the installer's invoice. (b) if the original installation date cannot be verified by the installer's invoice, or proof of purchase from the builder in residential new construction applications, then the Effective Date of warranty coverage is the Covered Equipment's manufacture date (as verified by the product's serial number) plus ninety (90) days.

There is NO LABOR component provided with this warranty. This Limited Warranty does NOT cover any labor costs or expenses for service, NOR for removing or reinstalling parts. You are responsible for all labor costs or expenses, unless a labor service agreement exists between you and your contractor.

This Limited Warranty does NOT cover shipping costs. You are responsible for the cost of shipping warranty replacement parts from our factory to the Manufacturer's distributor and from the distributor to the location of your Covered Equipment. You also are responsible for the cost of shipping failed parts to the distributor and for incidental costs incurred locally, including handling charges. (If in Alaska, Hawaii or Canada, you also must pay the shipping costs of returning the failed part to the port of entry into the continental United States.)

### EXCLUSIONS

In addition to the other exclusions identified in this Limited Warranty, this Limited Warranty excludes:

- Damages, malfunctions, or failures resulting from failure to properly install, operate, or maintain Covered Equipment in accordance with the Manufacturer's instructions.
- Damages, malfunctions, or failures resulting from misuse, accident, contaminated, or corrosive atmosphere, vandalism, freight damage, fire, flood, freeze, lightning, acts of war, acts of God and the like.
- Parts installed with Covered Equipment or used in connection with normal maintenance, such as cleaning or replacing air filters, refrigerant, thermostats, tubing, or concrete pads.
- Covered Equipment that is not installed in the United States.

- Covered Equipment that is not installed by a qualified, trained HVAC professional in accordance with applicable codes, ordinances, and good trade practices.
- Damages, malfunctions, or failures resulting from the use of any attachment, accessory, or component not authorized by the Manufacturer or resulting from alteration or modification of the unit.
- Covered Equipment moved from the original installation location.
- Covered Equipment when operated with system components (indoor unit, outdoor unit, coil, and refrigerant control devices) or accessories which do not match or meet the specifications recommended by the Manufacturer.
- Any Covered Equipment manufactured that has been sold to the consumer via the Internet or auction website, and has not been installed by a trained, qualified HVAC professional.
- Covered Equipment that is not part of a properly matched system as specified by the Air Conditioning, Heating & Refrigeration Institute (AHRI).

#### COMMERCIAL WARRANTY

Installations in commercial applications carry a ONE (1) YEAR PARTS warranty following the other provisions in this Limited Warranty.

#### OBTAINING WARRANTY SERVICE

If you believe your product is defective, contact the licensed contractor who installed your mini-split system. Alternatively, contact a licensed contractor, dealer, or distributor.

Durastar Customer Support is available for troubleshooting assistance. Before contacting Customer Support, please locate your model number, serial number, and proof of purchase. These items will be required to complete any warranty service. A Durastar authorized representative will verify warranty eligibility and determine appropriate service options. Service will be provided during normal business days and hours.

THIS WARRANTY IS IN LIEU OF ANY OTHER WARRANTY, EXPRESS OR IMPLIED, INCLUDING WITHOUT LIMITATION, ANY WARRANTY OF MERCHANTABILITY OR FITNESS FOR A PARTICULAR PURPOSE. TO THE EXTENT ANY IMPLIED WARRANTY IS REQUIRED BY LAW, IT IS LIMITED IN DURATION TO THE EXPRESS WARRANTY PERIOD ABOVE. NEITHER THE MANUFACTURER NOR ITS DISTRIBUTORS SHALL BE LIABLE FOR ANY INCIDENTAL, CONSEQUENTIAL, INDIRECT, SPECIAL, OR PUNITIVE DAMAGES OF ANY NATURE, INCLUDING WITHOUT LIMITATION, LOST REVENUES OR PROFITS, OR ANY OTHER DAMAGE WHETHER BASED IN CONTRACT, TORT, OR OTHERWISE. IN NO EVENT AND UNDER NO CIRCUMSTANCE OF ANY TYPE OR KIND SHALL THE SELLER, MANUFACTURER AND/OR DISTRIBUTOR BE LIABLE FOR ANY REASON, UNDER ANY THEORY, FOR MORE THAN THE BASIC COST OF THE PRODUCT TO THE PURCHASER OR END USER. SOME STATES DO NOT ALLOW THE EXCLUSION OF INCIDENTAL OR CONSEQUENTIAL DAMAGES, SO THE ABOVE EXCLUSION MAY NOT APPLY TO YOU. THIS WARRANTY GIVES YOU SPECIFIC LEGAL RIGHTS. YOU MAY HAVE OTHER RIGHTS THAT VARY FROM STATE TO STATE.



OWNER'S MANUAL

**WALL MOUNTED INDOOR UNIT  
SPLIT-STYLE AIR CONDITIONER**

DRAW06F1B, DRAW09F1B, DRAW12F1B,  
DRAW18F1B, DRAW24F1B

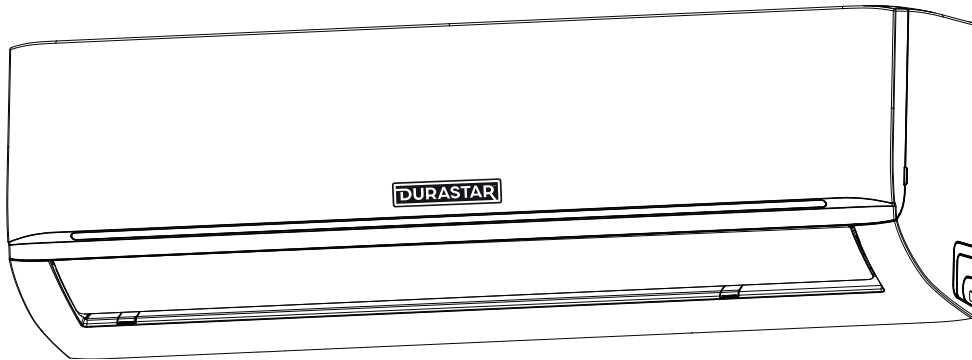

Model Number:

Serial Number:

Purchase Date:

Installing Contractor Company Name:



**TIP**

Capture relevant information about your Durastar mini-split equipment before it is installed and write it above for future reference.

## TABLE OF CONTENTS

TABLE OF CONTENTS .....	2
INTRODUCTION .....	3
WARNINGS .....	3
IMPORTANT SAFETY PRECAUTIONS.....	4
PARTS IDENTIFICATION .....	7
INCLUDED ACCESSORIES .....	8
OPERATING TEMPERATURES.....	9
REMOTE CONTROL.....	10
REMOTE CONTROL SCREEN INDICATORS .....	11
OPERATING MODES .....	12
ADVANCED BUTTONS AND FEATURES .....	13
LOUVERED AIR FLOW .....	17
LED DISPLAY INDICATORS.....	18
MANUAL OPERATION (USE WITHOUT REMOTE) .....	18
CARE AND MAINTENANCE .....	19
TROUBLESHOOTING.....	21
LIMITED WARRANTY - PARTS.....	26

## INTRODUCTION

To better serve you, please do the following before contacting customer service:

- If you received a damaged product, immediately contact the retailer or dealer that sold you the product.
- Read and follow this owner's manual carefully to help you use and maintain your air conditioner.
- Read the troubleshooting section of this manual as it will help you diagnose and solve common issues.
- Visit us on the web at [www.durastar.com](http://www.durastar.com) to download product guides and up-to-date information.
- If you need warranty service, our friendly customer service representatives are available via email at [questions@durastar.com](mailto:questions@durastar.com) or by telephone at 1-888-320-0706.

## WARNINGS

### Symbols Used in This Manual



The warning symbol indicates cautionary information for the user. Extra care and precautions should be taken to ensure the user's safety.



The pencil indicates any manufacturer notes relating to surrounding content. These may include further clarifications or call-outs.



A light bulb symbol indicates suggested manufacturer tips for the user to get the most out of the Durastar equipment and to accommodate the best user experience.

## IMPORTANT SAFETY PRECAUTIONS

Improper handling can cause serious damage or injury. Please read the following safety information in its entirety.



### **Operation, Cleaning, and Maintenance Safety Precautions**

- Children and people with reduced physical, sensory, or mental capabilities, or lack of experience and knowledge, should only use this air conditioner if they are given supervision or instructions concerning use of the air conditioner in a safe way and understand the hazards involved.
- Children should not play with the air conditioner.
- Never stick fingers or any other body parts into the air conditioner openings. The internal fan may be rotating at high speeds, and may result in injury.
- After removing the filter, do not touch the fins in order to avoid injury.
- Maintenance must be performed by qualified professionals. Otherwise, you may experience personal injury or damage to the air conditioner and surrounding property.
- Do not repair the air conditioner by yourself. It may cause electric shock or damage. Please contact a qualified service representative when you need to repair the air conditioner.
- Do not block the air outlet or air inlet. This could cause a malfunction.
- Do not spill water on the remote control as this can permanently damage the remote.
- If the below problems occur, please turn off the air conditioner and disconnect power at the circuit breaker immediately. Then contact your dealer or a qualified professional for service.
  - The power cord is overheating or damaged.
  - There is an abnormal sound during operation.
  - The circuit breaker trips frequently.
  - The air conditioner gives off a burning smell.
  - The indoor unit is leaking.
- If the air conditioner operates under abnormal conditions, it may cause malfunctions, electric shock, or fire hazard.
- When turning the unit on or off via the emergency operation switch, press the switch with an insulated object other than metal.
- Do not step on the top panel of the unit, or put heavy objects on the top panel. This could cause damage or personal injury.
- Cleaning and user maintenance should not be performed by children without supervision.
- Do not spray water on the indoor unit. This could cause electric shock or a unit malfunction.
- Do not use flammable materials such as hair spray, lacquer, or paint near the air conditioner as they may catch fire.
- Do not operate the air conditioner in places near combustible gases. Emitted gases may collect around the air conditioner and cause an explosion.
- Do not use fire or a hair dryer to dry the filter. This could cause a deformation or fire hazard.
- Do not wash the air conditioner with water as this could cause an electric shock.
- Disconnect the power supply by turning it off at the circuit breaker when cleaning the air conditioner. Otherwise, you could risk electric shock.



**Electrical Safety**

- Do not modify the length of the power supply cord or use an extension cord to power the unit.
- If the supply cord is damaged, it must be replaced by the manufacturer, a service agent, or a similarly qualified person in order to avoid a safety hazard.
- Do not share the electrical outlet with other appliances. Improper or insufficient power supply can cause fire or electrical shock.
- The product must be properly grounded at the time of installation, or electrical shock may occur.
- For all electrical work, follow all local and national wiring standards and regulations. Connect cables tightly, and clamp them securely to prevent external forces from damaging the terminal. Improper electrical connections can overheat and cause fire, and may also cause shock. All electrical connections must be made according to the Electrical Connection Diagram located on the panels of the indoor and outdoor units.
- All wiring must be properly arranged to ensure that the control board cover can close properly. If the control board cover is not closed properly, it can lead to corrosion and cause the connection points on the terminal to heat up, catch fire, or cause electrical shock.
- The air conditioner's circuit board (PCB) is designed with a fuse to provide overcurrent protection. The specifications of the fuse are printed on the circuit board.



### **Installation Safety**

- Installation must be performed by an authorized dealer or specialist. Improper installation can cause water leakage, electrical shock, or fire. (In North America, installation must be performed in accordance with NEC and CEC requirements by authorized personnel only.)
- Installation must be performed according to the installation instructions. Improper installation can cause water leakage, electrical shock, or fire.
- This air conditioner shall be installed in accordance with national and local wiring regulations.
- Contact an authorized service technician for repair or maintenance of this unit.
- Only use the included accessories, parts, and specified parts for installation. Using non-standard parts can cause water leakage, electrical shock, fire, and can cause the unit to fail.
- Install the unit in a firm location that can support the unit's weight. If the chosen location cannot support the unit's weight, or the installation is not done properly, the unit may fall and cause serious injury and damage.
- Install drainage piping according to the instructions in the installation manual. Improper drainage may cause water damage to your home and property.
- Do not install the unit in a location that may be exposed to combustible gas leaks. If combustible gas accumulates around the unit, it may cause a fire.
- Do not turn on the power until all work has been completed.
- When moving or relocating the air conditioner, consult experienced service technicians for disconnection and re-installation of the unit.



### **Additional Precautions**

- Turn off the air conditioner and disconnect the power if you are not going to use it for a long time.
- Turn off the unit during electrical storms to avoid damaging the unit.
- Make sure that water condensation can drain unhindered from the unit.
- Do not operate the air conditioner with wet hands. This may cause electric shock.
- Do not use this device for any other purpose than its intended use.
- Do not climb onto or place objects on top of the outdoor unit.
- Do not allow the air conditioner to operate for long periods of time with doors or windows open, or if the humidity is very high.

# PARTS IDENTIFICATION

## INDOOR UNIT

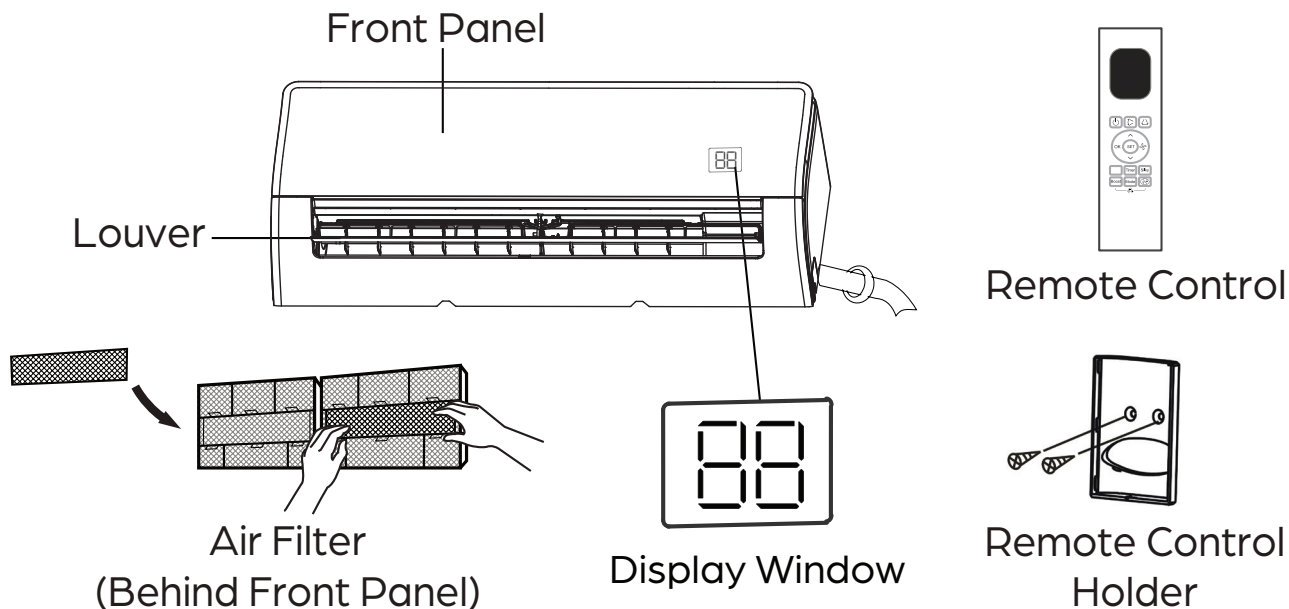

## OUTDOOR UNIT

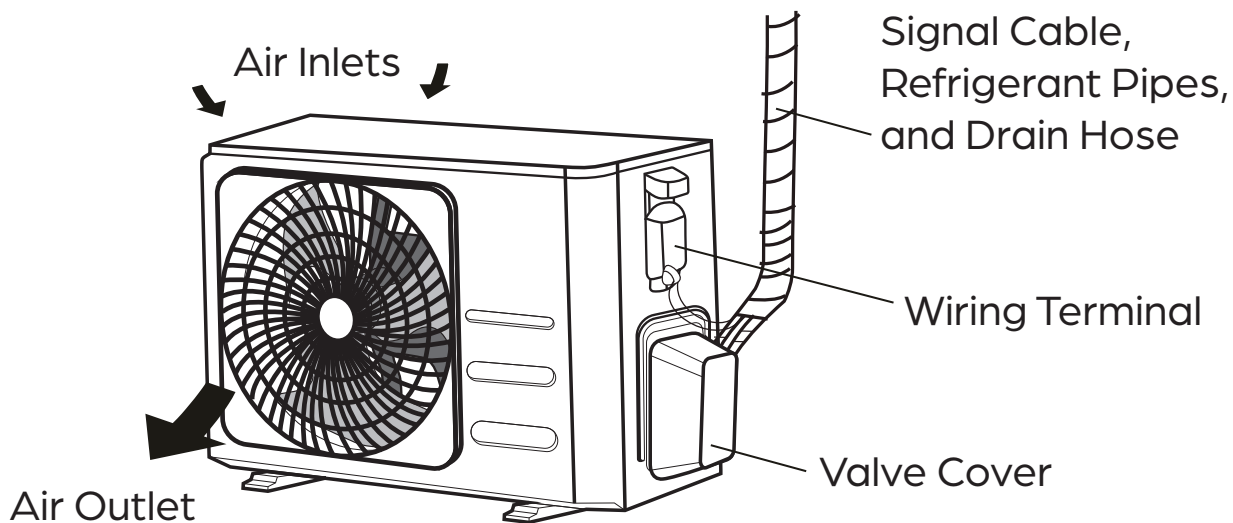









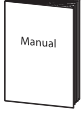

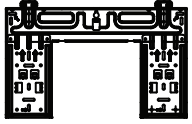
**NOTE**

Outdoor units will vary in appearance.

## INCLUDED ACCESSORIES

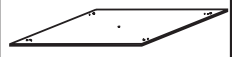
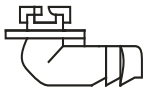
The air conditioning system comes with the following accessories.

Accessory	Quantity	Image	Accessory	Quantity	Image
Manual	1-2		Remote Control	1	
Mounting Plate	1		Battery	2	
Wall Anchor	5-8 (depending on model)		Remote Control Holder	1	
Mounting Plate Screw	5-8 (depending on model)		Remote Control Holder Mounting Screw	2	
Copper Nut	2		Installation Template	1	
Drain Joint	1		Carbon Filter	2	
Drain Joint Seal	1				

## OPERATING TEMPERATURES

Your air conditioner is designed to operate in the following indoor and outdoor temperatures. When your air conditioner is used outside of the following temperature ranges, certain safety features may activate and turn off the unit to protect it from damage.

### TEMPERATURE RANGES

	<b>COOL Mode</b>	<b>HEAT Mode</b>	<b>DRY Mode</b>
<b>Indoor Air Temperature</b>	60°F – 90°F (16°C – 32°C)	32°F – 86°F (0°C – 30°C)	50°F – 90°F (10°C – 32°C)
<b>Outdoor Air Temperature</b>	5°F – 122°F (–15°C – 50°C)	–13°F – 75°F* (–25°C – 24°C)*	32°F – 122°F (0°C – 50°C)

\* The minimum operating temperature depends on the outdoor unit. Low ambient models have a minimum operating temperature in heat mode of –22°F (–30°C).

To further optimize the performance of your unit, do the following:

- Keep doors and windows closed.
- Limit energy usage by using TIMER ON and TIMER OFF features.
- Do not block air inlets or outlets.
- Regularly inspect and clean air filters.

#### **NOTE**



Your Durastar heat pump's outdoor unit is equipped with a base pan heater, allowing it to continue to operate at freezing temperatures as low as –22°F (–30°C). When outdoor air temperatures are at or below 32°F (0°C), we strongly recommend keeping the unit plugged in at all times to ensure smooth, ongoing performance.

#### **NOTE**



Keep the room's relative humidity below 80%. If the air conditioner operates in excess of this, the surface of the air conditioner may attract condensation. To help prevent condensation from forming and dripping, set the vertical airflow louver to its maximum angle (vertically to the floor) and set the fan to HIGH.

## REMOTE CONTROL

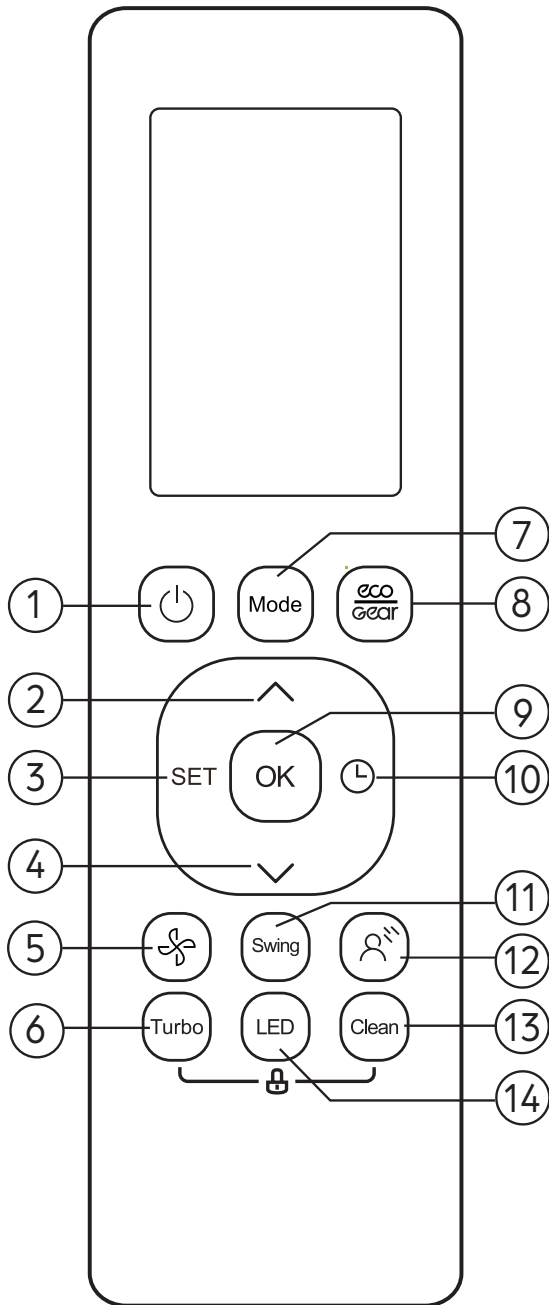

### 1. ON/OFF Button

Turns the air conditioner ON and OFF.

### 2. UP Button (▲)

Press to increase the set temperature in 1°F / 1°C increments .

### 3. SET Button

Press to access the SET features menu. See "Advanced Buttons and Features" section.

### 4. DOWN Button (▼)

Press to decrease the set temperature in 1°F / 1°C increments. Press (▲) and (▼) at the same time for 3 seconds to switch between °F and °C.

### 5. FAN Button

Press to select FAN speed.

### 6. TURBO Button

Press to turn on and off the TURBO feature. See "Advanced Buttons and Features" section.

### 7. MODE Button

Press to adjust the air conditioner MODE in the following sequence: → AUTO → COOL → DRY → HEAT → FAN →

### 8. ECO/GEAR Button

Press to enter one of three energy efficiency modes. See "Advanced Buttons and Features" section.

### 9. OK Button

Press to confirm selected functions.

### 10. TIMER Button

Press to initiate the TIMER feature. See "Advanced Buttons and Features" section.

### 11. SWING Button

Press to start and stop the automatic horizontal louver movement or set a fixed louver angle.

### 12. GENTLE Button

Press to stop the air flow from blowing directly on you if it becomes uncomfortable. See "Advanced Buttons and Features" section.

### 13. CLEAN Button

Turns on and off the CLEAN feature. See "Advanced Buttons and Features" section.

### 14. LED Button

Press to turn on and off the indoor unit's display screen.

# REMOTE CONTROL SCREEN INDICATORS

## Transmission Indicator

Lights up when remote sends signal to indoor unit.



**TIMER ON** display



**TIMER OFF** display



**SILENCE** feature display

## FAN SPEED display

Displays selected fan speed:

Silence		1%
		2%-20%
LOW		21%-40%
MED		41%-60%
		61%-80%
HIGH		81%-100%
AUTO		

The fan speed cannot be adjusted in AUTO or DRY mode.

Note:

Not all the models can display the fan speed values between AUTO-100%.

- GENTLE** feature display
- CLEAN** feature display
- SLEEP** feature display
- FOLLOW ME** feature display
- Network display (not available for this unit)
- Low battery display (If flashing)

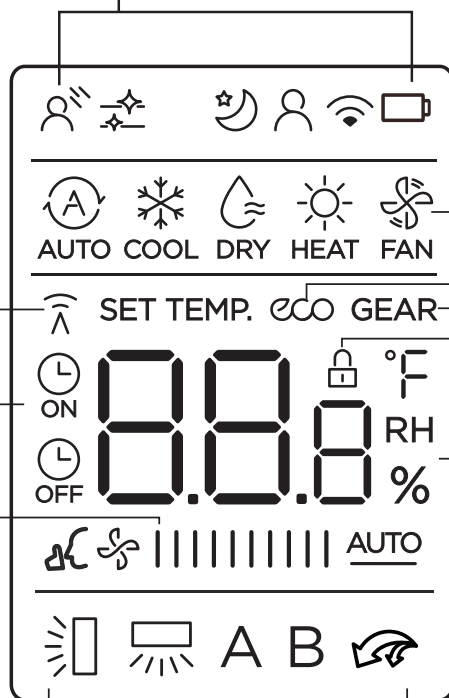

## MODE display

Displays the current mode, including:



## ECO display

Displays when ECO feature is activated.

## GEAR display

Displays when GEAR feature is activated.

## LOCK display

Displays when LOCK feature is activated.

Temperature/Timer/ Fan Speed % display  
Displays the set temperature unless the fan speed or timer setting functions are in use.

## TIMER ON/OFF functions.

- Temperature range: 60-86°F (16-30°C)
  - Timer setting range: 0-24 hours
  - Fan speed setting range: AUTO -100%
- This display is blank when operating in **FAN** mode.

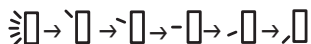

**Horizontal** louver swing display



**Vertical** louver swing (not available on unit)



**TURBO** feature display



**A** Not available for this unit  
**B** Not available for this unit





## NOTE

All indicators shown in the above figure are for purposes of clear representation. During actual operation, only the relative indicators are illuminated in the display window.

## OPERATING MODES ( )

### SETTING TEMPERATURE

This unit can be set at any temperature within its operating range in AUTO, COOL, HEAT, and DRY modes (see "Temperature Ranges" section). You can increase or decrease the set temperature in 1°F (1°C) increments by pressing the UP (  ) or DOWN (  ) button.

### AUTO ( )

In AUTO mode, the unit will automatically select the COOL, FAN, HEAT, or DRY modes to maintain the set temperature. In AUTO mode, the fan speed cannot be set.

1. Select AUTO mode
2. Set desired temperature
3. Turn on air conditioner

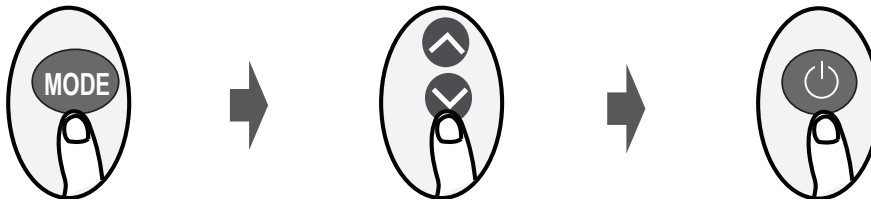

### COOL or HEAT ( or )

1. Select COOL or HEAT mode
2. Set desired temperature
3. Set fan speed
4. Turn on air conditioner

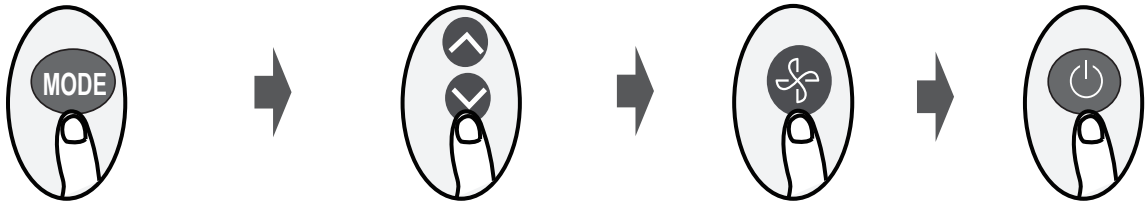

### DRY/DEHUMIDIFY ( )

In DRY mode, the fan runs continuously on low speed. The unit will operate continuously until it reaches 50°F (10°C), at which time it will turn off. DRY mode operation will then resume once the room temperature reaches 54°F (12°C).

1. Select DRY mode
2. Set any temperature
3. Turn on air conditioner

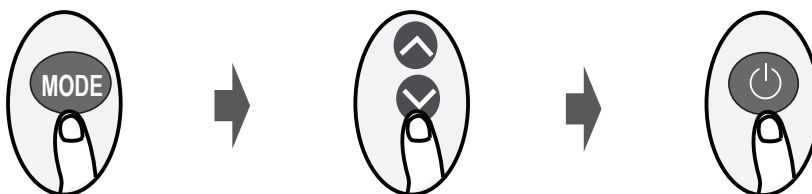

#### NOTE

\*For this series of mini-splits, changing the temperature in DRY mode does not deviate performance from the above mode description.



#### NOTE

The FAN speed cannot be adjusted in AUTO or DRY Mode.



#### NOTE

Press and hold the UP and DOWN buttons simultaneously for 3 seconds to switch between °F and °C.



## FAN ( )

In FAN mode, the temperature cannot be set and no temperature will be displayed on the remote screen.

1. Select FAN mode

2. Set fan speed

3. Turn on air conditioner



### NOTE

You cannot adjust the temperature in FAN mode. As a result, your remote control's LCD display will not display a temperature.



### NOTE

As outdoor temperature drops, the performance of your unit's HEAT function may be affected.



### NOTE

Two or more indoor units can be operated by one outdoor unit. However, two or more indoor units cannot operate simultaneously when different operating modes have been selected. If COOL/DRY/FAN is selected with one or more indoor units and HEAT with another, the unit(s) in HEAT has priority.

## ADVANCED BUTTONS AND FEATURES

### ECO/GEAR ( )

The ECO/GEAR feature provides three levels of energy saving options. ECO/GEAR is only available in COOL mode. Some of these options may result in insufficient cooling in circumstances of high ambient heat. The ECO/GEAR feature is not available in multiple zone configurations.

#### ECO ( *eco* )

While the unit is in COOL mode, press the ECO/GEAR button once. If the set temperature is above 75°F (24°C) the FAN speed will be set to AUTO. If the set temperature is below 75°F (24°C) it will automatically be adjusted to 75°F (24°C) and the FAN speed will be set to AUTO. When functioning in this mode, the unit can reduce its energy consumption up to 10%. Press the ECO/GEAR button to turn off this feature.

#### GEAR ( GEAR )

GEAR has two levels – 25% and 50% energy consumption. While the unit is in COOL mode, press the ECO/GEAR button twice (x2) within two (2) seconds to select 25% or three times (x3) to select 50%. If the set temperature is above 75°F (24°C) the FAN speed will be set to AUTO. If the set temperature is below 75°F (24°C) it will automatically be adjusted to 75°F (24°C) and the FAN speed will be set to AUTO. When functioning in these modes, the unit can reduce its energy consumption up to 25% or 50%. Press the ECO/GEAR button to turn off this feature.



### NOTE

The overall energy consumption of the unit is affected by many factors and this feature's energy reduction level setting will not result in directly proportional money savings on your energy bill.

## SET BUTTON FEATURES ( SET )

Press the SET button to open the feature menu at the top of the display. Next, press SET or UP (▲) and DOWN (▼) to highlight the desired feature's icon. Finally, press OK to activate it.

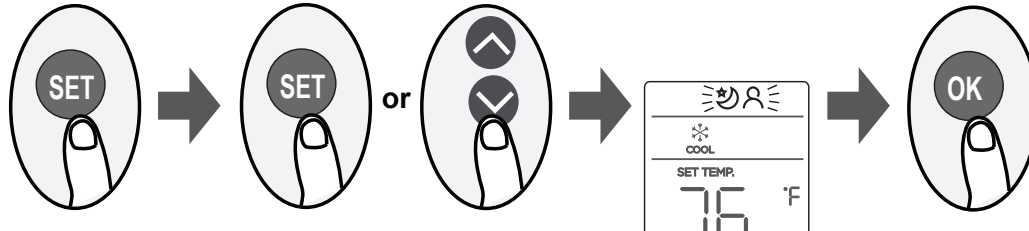

## SLEEP ( 🌙 )

The SLEEP feature is designed to decrease energy use while you sleep. The SLEEP feature is not available in FAN or DRY mode.

When you are ready to go to sleep, press the SET button, select the SLEEP icon and press OK. When in COOL mode, the unit will increase the temperature by 2°F (1°C) after one hour, and will increase an additional 2°F (1°C) after another hour. When in HEAT mode, the unit will decrease the temperature by 2°F (1°C) after one hour, and will decrease an additional 2°F (1°C) after another hour.

The SLEEP feature will turn off after eight hours and the system will return to normal functioning.

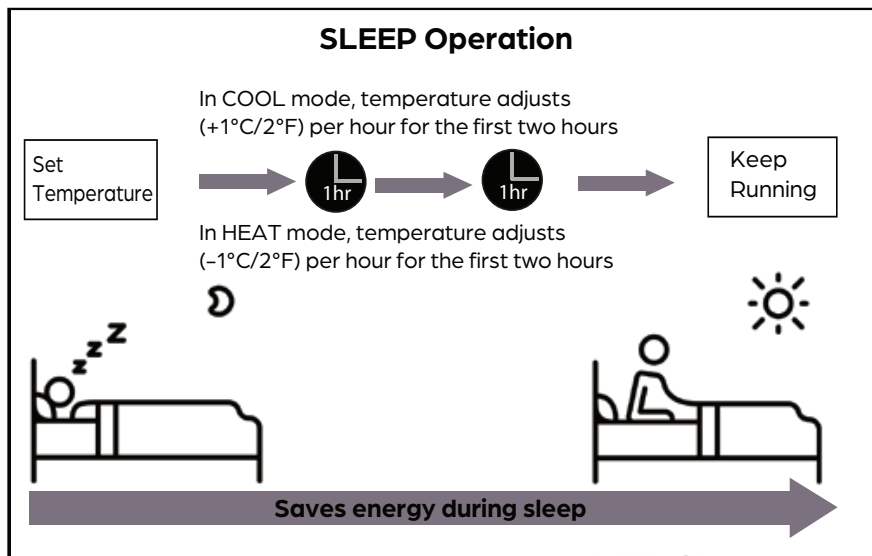

## FOLLOW ME ( 👤 )

This feature uses the temperature at the remote's location, instead of the indoor unit's location, to optimize the temperature around you and ensure maximum comfort. To activate the FOLLOW ME feature, press the SET button, select the FOLLOW ME icon and press OK. To deactivate FOLLOW ME press ON/OFF or change the MODE.

To lock the FOLLOW ME feature, press and hold the TURBO button for seven (7) seconds. The remote will display "ON" for three (3) seconds and the temperature at its location. When using AUTO, COOL, and HEAT modes the air conditioner will continue running until the temperature at the remote's location is satisfied. Power failures, pressing ON/OFF or changing MODES will no longer cancel the feature. Press and hold the TURBO button again for seven (7) seconds to unlock and turn off this feature. The remote will display "OF" for three (3) seconds.

## NETWORK SETUP ( 📶 )

This feature is not available on this unit.

**TIMER (🕒)**

The TIMER feature establishes the amount of time that will elapse before the unit will automatically turn on/off.

1. Press TIMER button to initiate the time ON sequence.
2. Press UP or DOWN button the required number of times to set the desired time to turn on the unit.
3. Point remote at unit for 1 second. The TIMER ON will be activated.

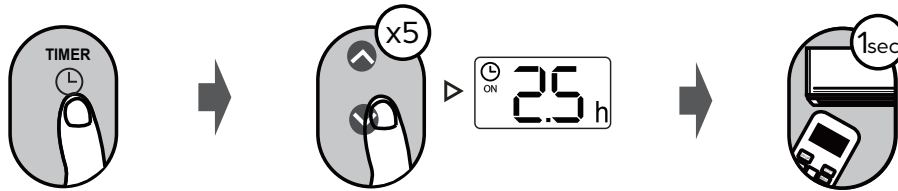

1. Press TIMER button to initiate the time OFF sequence.
2. Press UP or DOWN button the required number of times to set the desired time to turn on the unit.
3. Point remote at unit for 1 second. The TIMER OFF will be activated.

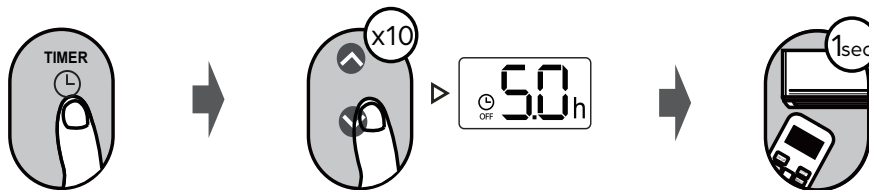

**TIMER ON and OFF setting example.**

Keep in mind that the time periods you set for both the on and off feature refers to hours after the current time.

If the current time is 1:00 PM and the TIMER ON setting is adjusted to 2.5 hours, the auto-on time sequence will turn the air conditioner on 2.5 hours later at 3:30 PM. Setting the TIMER OFF auto-off sequence to 5.0 hours will turn off the air conditioner 5 hours later at 6:00 PM.

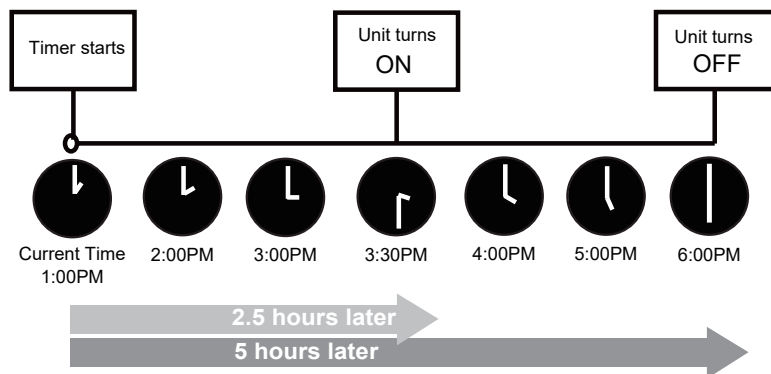

**GENTLE (🌀)**

If the air flow from the unit becomes uncomfortable because it is too intense or blowing directly on you, simply press the GENTLE button to slow the unit and divert the air flow away from you. Press the GENTLE button again to turn this feature off. This feature is only available under COOL, DRY, and FAN modes. This feature is not available in multiple zone configurations.

**TURBO** (  )

Press the TURBO button to turn this feature on and off. The TURBO feature enables the unit to reach the set temperature in the shortest time by automatically controlling the fan speed. This feature is only available in COOL and HEAT modes.

**LED** (  )

Press the LED button to turn on and off the display of the indoor unit.

**CLEAN** (  )

Airborne bacteria can grow in the moisture that condenses around the heat exchanger in the unit. With regular use, most of this moisture is evaporated from the unit. By pressing the CLEAN button, your unit will clean itself automatically. After cleaning, the unit will turn off automatically. Pressing the CLEAN button mid-cycle will cancel the operation and turn off the unit. You can use CLEAN as often as you like. You can only activate the CLEAN function in COOL or DRY modes. This feature is not available in multiple zone configurations.

**SILENCE** (  )

Press the FAN button for two (2) seconds to turn on and off the SILENCE feature. When the SILENCE feature is activated, the compressor will slow and the indoor unit will turn the fan to low. This will reduce the noise of the indoor unit to the lowest level. Due to the slow operation of the compressor, it may result in insufficient cooling and heating capacity. This feature is not available in multiple zone configurations.

**FREEZE PROTECTION (FP)**

The FREEZE PROTECTION feature sets the indoor temperature to 46°F (8°C). The unit will maintain this temperature and prevent indoor pipes and household items from freezing when the house is unoccupied for long periods of time in the winter. The display will show "FP" when this feature is on.

To activate, first turn the unit to HEAT mode and set the temperature to 60°F (16°C). Then, press the DOWN (  ) button twice (x2) in one (1) second to start the FREEZE PROTECTION feature. Press the ON/OFF button to turn off the feature. This feature is only available in HEAT mode.

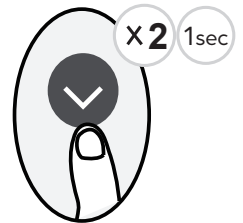
**LOCK** (  )

The LOCK feature disables the remote's buttons so your settings cannot be changed. To activate the remote LOCK feature, simultaneously press the CLEAN and TURBO buttons for five (5) seconds. To turn off the LOCK feature, simultaneously press CLEAN and TURBO again for five (5) seconds.

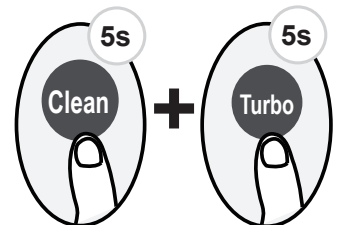
**AUTO-RESTART**

The AUTO-RESTART feature is enabled when power is interrupted to the unit. After power is restored, the unit will automatically return to its prior settings before power was lost. No buttons need to be pressed to set this feature – it is automatic.

## REFRIGERANT LEAK DETECTION (EC)

The indoor unit will automatically display "EC" when it detects a refrigerant leak. If a leak is detected, turn off your unit and contact your dealer or certified technician for service.

## LOUVERED AIR FLOW

### SETTING VERTICAL ANGLE ( )

While the unit is on, press the SWING button on the remote control to set the vertical direction of airflow.

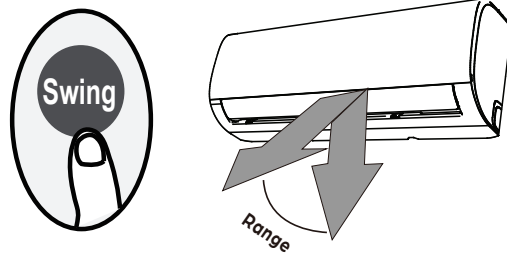

### AUTOMATIC SWING ( )

Press the SWING button once to start the automatic vertical (up and down) movement of the louver. Press again to make it stop.

### FIXED LOUVER ANGLE ( )

Quickly press the SWING button 2–6 times to adjust the fixed angle of the louver. Each press will adjust the louver by 6°. Press the button until the desired angle is reached. The remote will display the selected angle.



#### NOTE

Do not move louver by hand. This will cause the louver to become out of sync. If this occurs, turn off the unit and shut off the breaker for 30 seconds, then restart the unit. This will reset the louver.

## SETTING HORIZONTAL ANGLE

The horizontal angle of the airflow must be set manually. Grip the deflector rod and manually adjust it to your preferred direction.

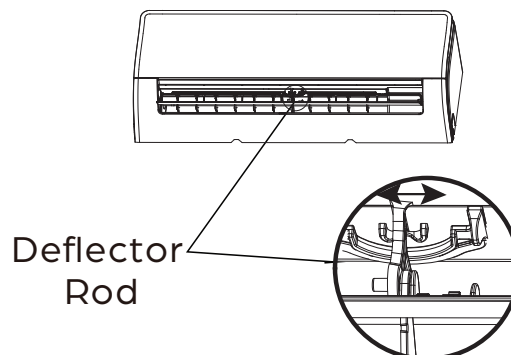

#### CAUTION

Do not put your fingers in or near the blower and suction side of the unit. The high-speed fan inside the unit may cause injury.

## LED DISPLAY INDICATORS

The following is a list of possible indicators that may appear on the indoor unit's display. Not all the display indicators may be available on the unit purchased.

Feature	Indicator	Notes
TIMER ON, SWING, TURBO, SILENCE	ON	Displays for 3 seconds when the TIMER ON feature is set or the SWING, TURBO, or SILENCE feature is turned on. If the unit is off, ON will continue to be shown if the TIMER ON feature is set.
TIMER OFF, SWING, TURBO, SILENCE	OF	Displays for 3 seconds when the TIMER OFF feature is set or the SWING, TURBO, or SILENCE feature is turned off.
CLEAN	CL	Displays when the CLEAN feature is on.
FREEZE PROTECTION	FP	Displays when the FREEZE PROTECTION feature is on.
FORCED COOLING	FC	Displays when the FORCED COOLING mode is selected with the manual control button. See Manual Operation section.
ANTI-COLD AIR FLOW	cF	The unit is designed not to blow cold air in HEAT mode. When HEAT mode is selected the unit will display "cF" until the set temperature is reached and the unit can blow warm air.
DEFROST	dF	Displays when unit is defrosting. This may last 5-10 minutes depending on the outdoor temperature and the amount of frost buildup on the outside unit.
REFRIGERANT LEAK	EC	Displays if a refrigerant leak is detected. Turn off your unit and contact your dealer or certified technician for service.

## MANUAL OPERATION (USE WITHOUT REMOTE)

The manual override button is intended for testing purposes and emergency operation. Please do not use this button unless the remote control is lost and it is absolutely necessary. The unit must be turned off before manual operation.

To operate your unit manually:

1. Open the front panel of the indoor unit.
2. Locate the MANUAL CONTROL button on the right-hand side of the unit.
3. Press the MANUAL CONTROL button one time to activate FORCED AUTO mode.
4. Press the MANUAL CONTROL button again to activate FORCED COOLING mode.
5. Press the MANUAL CONTROL button a third time to turn the unit off.
6. Close the front panel.

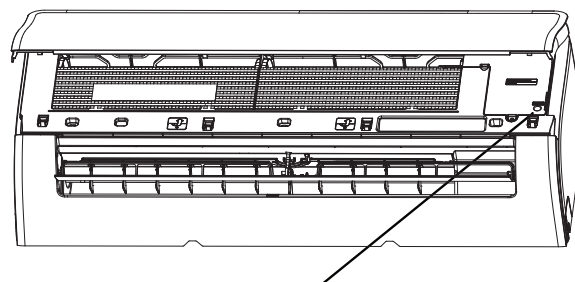

Manual Control  
Button

## CARE AND MAINTENANCE



### CAUTION

- Always turn off the unit and disconnect power before cleaning or maintenance.
- Only use a soft, dry cloth to wipe the unit clean. If the unit is especially dirty, you can use a cloth soaked in warm water to wipe it clean.

### CLEANING INDOOR UNIT

- Do not use chemicals or chemically treated cloths to clean the unit.
- Do not use benzene, paint thinner, polishing powder or other solvents to clean the unit. They can cause the plastic surface to crack or deform.
- Do not use water hotter than 104°F (40°C) to clean the front panel. This can cause the panel to deform or become discolored.

### CLEANING THE AIR FILTER

A dirty air filter can reduce the cooling efficiency of your unit, and can also be bad for your health. Make sure to clean the filter once every two weeks.

1. Lift the front panel of the indoor unit.
2. Grip the tab on the end of the filter, lift it up, then pull it towards yourself.
3. Now pull the filter out.
4. If your filter has a small air freshening filter, unclip it from the larger filter. Clean this air freshening filter with a hand-held vacuum.
5. Clean the large air filter with warm, soapy water. Be sure to use a mild detergent.
6. Rinse the filter with fresh water, then shake off excess water.
7. Dry filter in a cool, dry place, and refrain from exposing it to direct sunlight.
8. When dry, re-clip the air freshening filter to the larger filter, then slide it back into the indoor unit.
9. Close the front panel of the indoor unit.

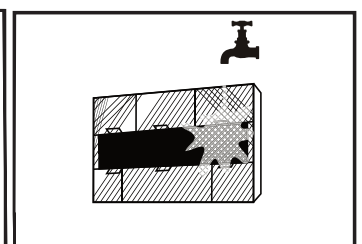
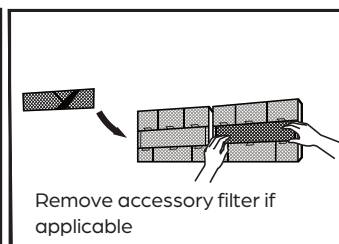
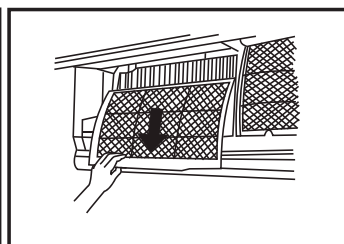
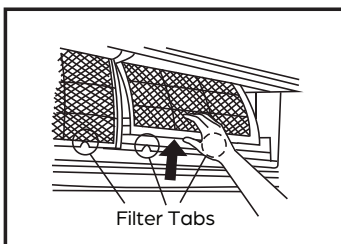

### CAUTION



- Before changing the filter or cleaning, turn off the unit and disconnect its power supply.
- When removing the filter, do not touch the metal parts in the unit. The sharp metal edges can cut you.
- Do not use water to clean the inside of the indoor unit. This can destroy insulation and cause electrical shock.
- Do not expose filter to direct sunlight when drying. This can shrink the filter.

**MAINTENANCE: LONG PERIODS OF NON-USE**

If you do not plan to use your air conditioner for an extended period of time, do the following:

- Clean all filters.
- Turn on the FAN until the unit dries out completely.
- Turn off the unit and disconnect the power.
- Remove batteries from remote control.

**MAINTENANCE: PRE-SEASON INSPECTION**

After long periods of non-use, or before periods of frequent use, do the following:

- Inspect for damaged wires.
- Clean all filters.
- Check for leaks.
- Replace batteries.
- Make sure nothing is blocking any air inlets or outlets.



# TROUBLESHOOTING

## SAFETY PRECAUTIONS

If ANY of the following conditions occur, turn off your unit immediately!

- The power cord is damaged or abnormally warm
- You smell a burning odor
- The unit emits loud or abnormal sounds
- A power fuse blows or the circuit breaker frequently trips
- Water or other objects fall into or out of the unit

**DO NOT ATTEMPT TO FIX THESE YOURSELF! CONTACT AN AUTHORIZED SERVICE PROVIDER IMMEDIATELY!**

## COMMON ISSUES

The following problems are not malfunctions and in most situations do not require repairs.

ISSUE	POSSIBLE CAUSES
<b>Unit does not turn on when pressing ON/OFF button</b>	The unit has a 3-minute protection feature that prevents the unit from overloading. The unit cannot be restarted within three minutes of being turned off.
<b>The unit changes from COOL/HEAT mode to FAN mode</b>	The unit may change its setting to prevent frost from forming on the unit. Once the temperature increases, the unit will start operating in the previously selected mode again.
	The set temperature has been reached, at which point the unit turns off the compressor. The unit will continue operating when the temperature fluctuates again.
<b>The indoor unit emits white mist</b>	In humid regions, a large temperature difference between the room's air and the conditioned air can cause white mist.
<b>Both the indoor and outdoor units emit white mist</b>	When the unit restarts in HEAT mode after defrosting, white mist may be emitted due to moisture generated during the defrosting process.
<b>The indoor unit makes noises</b>	A rushing air sound may occur when the louver resets its position.
	A squeaking sound may occur after running the unit in HEAT mode due to expansion and contraction of the unit's plastic parts.

ISSUE	POSSIBLE CAUSES
<b>Both the indoor unit and outdoor unit make noises</b>	Low hissing sound during operation: This is normal and is caused by refrigerant gas flowing through both indoor and outdoor units.
	Low hissing sound when the system starts, has just stopped running, or is defrosting: This noise is normal and is caused by the refrigerant gas stopping or changing direction.
	Squeaking sound: Normal expansion and contraction of plastic and metal parts caused by temperature changes during operation can cause squeaking noises.
<b>The outdoor unit makes noises</b>	The unit will make different sounds based on its current operating mode.
<b>Dust is emitted from either the indoor or outdoor unit</b>	The unit may accumulate dust during extended periods of non-use, which will be emitted when the unit is turned on. This can be mitigated by covering the unit during long periods of inactivity.
<b>The unit emits a bad odor</b>	The unit may absorb odors from the environment (such as furniture, cooking, cigarettes, etc.) which will be emitted during operations.
	The unit's filters have become moldy and should be cleaned.
<b>The fan of the outdoor unit does not operate</b>	During operation, the fan speed is controlled to optimize product operation.
<b>Operation is erratic, unpredictable, or unit is unresponsive</b>	Interference from cell phone towers and remote boosters may cause the unit to malfunction. In this case, try the following: <ul style="list-style-type: none"> <li>• Disconnect the power, then reconnect.</li> <li>• Press ON/OFF button on remote control to restart operation.</li> </ul>

**NOTE**



If problem persists, contact a local dealer or your nearest customer service center. Provide them with a detailed description of the unit malfunction as well as your model number.

## TROUBLESHOOTING

If trouble occurs, please check the following points before contacting a repair company.

PROBLEM	POSSIBLE CAUSES	SOLUTION
<b>Poor cooling performance</b>	Temperature setting may be higher than ambient room temperature.	Lower the temperature setting.
	The heat exchanger on the indoor or outdoor unit is dirty.	Clean the affected heat exchanger.
	The air filter is dirty.	Remove the filter and clean it according to instructions.
	The air inlet or outlet of either unit is blocked.	Turn the unit off, remove the obstruction and turn it back on.
	Doors and windows are open.	Make sure that all doors and windows are closed while operating the unit.
	Excessive heat is generated by sunlight.	Close windows and curtains during periods of high heat or bright sunshine.
	Low refrigerant due to leak or long-term use.	Check for leaks, re-seal if necessary and top off refrigerant.
	Too many sources of heat in the room (people, computers, electronics, etc.).	Reduce amount of heat sources.
<b>Poor heating performance</b>	The outdoor temperature is extremely low.	Use auxiliary heating device.
	Cold air is entering through doors and windows.	Make sure that all doors and windows are closed during use.
	Low refrigerant due to leak or long-term use.	Check for leaks, re-seal if necessary and top off refrigerant.
<b>The unit starts and stops frequently</b>	There's too much or too little refrigerant in the system.	Check for leaks and recharge the system with refrigerant.
	Incompressible gas or moisture has entered the system.	Evacuate and recharge the system with refrigerant.
	The compressor is broken.	Replace the compressor.
	The voltage is too high or too low.	Install a manostat to regulate the voltage.
<b>Indicator lamps continue flashing or error code appears</b>	<p>The unit may stop operation or continue to run safely. If the indicator lamps continue to flash or error codes appear, wait for about 10 minutes. The problem may resolve itself.</p> <p>If not, disconnect the power, then connect it again. Turn the unit on.</p> <p>If the problem persists, disconnect the power and contact your nearest customer service center.</p>	

<b>PROBLEM</b>	<b>POSSIBLE CAUSES</b>	<b>SOLUTION</b>
<b>The unit is not working</b>	Power failure	Wait for the power to be restored
	The power is turned off	Turn on the power
	The fuse is burned out	Replace the fuse
	Remote control batteries are dead	Replace the batteries
	The unit's 3-minute protection has been activated	Wait three minutes after restarting the unit
	Timer is activated	Turn timer off

**NOTE**

If your problem persists after performing the checks and diagnostics above, or an error code remains, turn off your unit immediately and contact an authorized service center.

**THIS PAGE INTENTIONALLY LEFT BLANK.**

## LIMITED WARRANTY – PARTS

### TEN (10) YEARS PARTS

Subject to all of the terms of this Limited Warranty, including, but not limited to, the specific exclusions set forth below and subject to the Manufacturer's right to inspect and validate the warranty claim as set forth below, Manufacturer will repair or replace, at its option, ANY PART of Covered Equipment that is found to be defective in materials or workmanship. If an exact replacement part is not available, an equivalent part or credit will be provided.

The parts are warranted for a period of ten (10) years to the original owner of the mini-split equipment under normal use and service. For a period of ten (10) years from the date of installation, if any parts prove defective due to improper workmanship and/or material, Durastar will replace any defective part without charge for the part. Replacement parts carry the balance of the original 10-year parts warranty.

To qualify:

- The mini-split equipment must be installed in a residential single-family home.\*
- The original mini-split equipment owner must reside in the single-family home.
- The mini-split equipment must be properly installed. This includes installation by a contractor licensed for HVAC installation following all local and state laws.
- Any part to be replaced must be made available in exchange for the replacement.

\*Single-family home is defined as any single-family dwelling, which includes apartments, condominiums, duplexes, and homes.

### EFFECTIVE DATE OF WARRANTY

The Effective Date of warranty coverage is determined as follows: (a) If the original installation date can be verified by the installer's invoice then the Effective Date of warranty coverage is the original installation date as shown on the installer's invoice. For residential new construction installations, the final occupancy permit, or proof of purchase from the builder can be substituted for the installer's invoice. (b) if the original installation date cannot be verified by the installer's invoice, or proof of purchase from the builder in residential new construction applications, then the Effective Date of warranty coverage is the Covered Equipment's manufacture date (as verified by the product's serial number) plus ninety (90) days.

There is NO LABOR component provided with this warranty. This Limited Warranty does NOT cover any labor costs or expenses for service, NOR for removing or reinstalling parts. You are responsible for all labor costs or expenses, unless a labor service agreement exists between you and your contractor.

This Limited Warranty does NOT cover shipping costs. You are responsible for the cost of shipping warranty replacement parts from our factory to the Manufacturer's distributor and from the distributor to the location of your Covered Equipment. You also are responsible for the cost of shipping failed parts to the distributor and for incidental costs incurred locally, including handling charges. (If in Alaska, Hawaii or Canada, you also must pay the shipping costs of returning the failed part to the port of entry into the continental United States.)

### EXCLUSIONS

In addition to the other exclusions identified in this Limited Warranty, this Limited Warranty excludes:

- Damages, malfunctions, or failures resulting from failure to properly install, operate, or maintain Covered Equipment in accordance with the Manufacturer's instructions.
- Damages, malfunctions, or failures resulting from misuse, accident, contaminated, or corrosive atmosphere, vandalism, freight damage, fire, flood, freeze, lightning, acts of war, acts of God and the like.
- Parts installed with Covered Equipment or used in connection with normal maintenance, such as cleaning or replacing air filters, refrigerant, thermostats, tubing, or concrete pads.
- Covered Equipment that is not installed in the United States.

- Covered Equipment that is not installed by a qualified, trained HVAC professional in accordance with applicable codes, ordinances, and good trade practices.
- Damages, malfunctions, or failures resulting from the use of any attachment, accessory, or component not authorized by the Manufacturer or resulting from alteration or modification of the unit.
- Covered Equipment moved from the original installation location.
- Covered Equipment when operated with system components (indoor unit, outdoor unit, coil, and refrigerant control devices) or accessories which do not match or meet the specifications recommended by the Manufacturer.
- Any Covered Equipment manufactured that has been sold to the consumer via the Internet or auction website, and has not been installed by a trained, qualified HVAC professional.
- Covered Equipment that is not part of a properly matched system as specified by the Air Conditioning, Heating & Refrigeration Institute (AHRI).

#### COMMERCIAL WARRANTY

Installations in commercial applications carry a ONE (1) YEAR PARTS warranty following the other provisions in this Limited Warranty.

#### OBTAINING WARRANTY SERVICE

If you believe your product is defective, contact the licensed contractor who installed your mini-split system. Alternatively, contact a licensed contractor, dealer, or distributor.

Durastar Customer Support is available for troubleshooting assistance. Before contacting Customer Support, please locate your model number, serial number, and proof of purchase. These items will be required to complete any warranty service. A Durastar authorized representative will verify warranty eligibility and determine appropriate service options. Service will be provided during normal business days and hours.

THIS WARRANTY IS IN LIEU OF ANY OTHER WARRANTY, EXPRESS OR IMPLIED, INCLUDING WITHOUT LIMITATION, ANY WARRANTY OF MERCHANTABILITY OR FITNESS FOR A PARTICULAR PURPOSE. TO THE EXTENT ANY IMPLIED WARRANTY IS REQUIRED BY LAW, IT IS LIMITED IN DURATION TO THE EXPRESS WARRANTY PERIOD ABOVE. NEITHER THE MANUFACTURER NOR ITS DISTRIBUTORS SHALL BE LIABLE FOR ANY INCIDENTAL, CONSEQUENTIAL, INDIRECT, SPECIAL, OR PUNITIVE DAMAGES OF ANY NATURE, INCLUDING WITHOUT LIMITATION, LOST REVENUES OR PROFITS, OR ANY OTHER DAMAGE WHETHER BASED IN CONTRACT, TORT, OR OTHERWISE. IN NO EVENT AND UNDER NO CIRCUMSTANCE OF ANY TYPE OR KIND SHALL THE SELLER, MANUFACTURER AND/OR DISTRIBUTOR BE LIABLE FOR ANY REASON, UNDER ANY THEORY, FOR MORE THAN THE BASIC COST OF THE PRODUCT TO THE PURCHASER OR END USER. SOME STATES DO NOT ALLOW THE EXCLUSION OF INCIDENTAL OR CONSEQUENTIAL DAMAGES, SO THE ABOVE EXCLUSION MAY NOT APPLY TO YOU. THIS WARRANTY GIVES YOU SPECIFIC LEGAL RIGHTS. YOU MAY HAVE OTHER RIGHTS THAT VARY FROM STATE TO STATE.

