

OWNER'S MANUAL

**SLIM DUCTED INDOOR UNIT
SPLIT-STYLE AIR CONDITIONER**

DRAD09F1A, DRAD12F1A, DRAD18F1A, DRAD24F1A

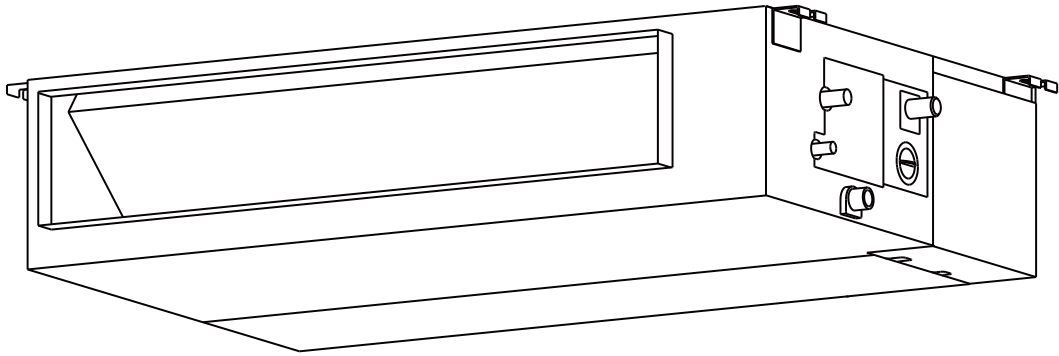

Model Number:

Serial Number:

Purchase Date:

Installing Contractor Company Name:



TIP

Capture relevant information about your Durastar mini-split equipment before it is installed and write it above for future reference.

TABLE OF CONTENTS

TABLE OF CONTENTS	2
INTRODUCTION	3
WARNINGS	3
IMPORTANT SAFETY PRECAUTIONS.....	4
PARTS IDENTIFICATION	7
INDOOR UNIT.....	7
OUTDOOR UNIT	7
INCLUDED ACCESSORIES	8
OPERATING TEMPERATURES.....	9
WIRED THERMOSTAT	10
OPERATING MODES	11
ADVANCED FEATURES.....	12
LED DISPLAY INDICATORS.....	14
MANUAL OPERATION (USE WITHOUT THERMOSTAT)	14
CARE AND MAINTENANCE	15
TROUBLESHOOTING.....	17
LIMITED WARRANTY - PARTS.....	21

INTRODUCTION

To better serve you, please do the following before contacting customer service:

- If you received a damaged product, immediately contact the retailer or dealer that sold you the product.
- Read and follow this owner's manual carefully to help you use and maintain your air conditioner.
- Read the troubleshooting section of this manual as it will help you diagnose and solve common issues.
- Visit us on the web at www.durastar.com to download product guides and up-to-date information.
- If you need warranty service, our friendly customer service representatives are available via email at questions@durastar.com or by telephone at 1-888-320-0706.

WARNINGS

Symbols Used in This Manual



The warning symbol indicates cautionary information for the user. Extra care and precautions should be taken to ensure the user's safety.



The pencil indicates any manufacturer notes relating to surrounding content. These may include further clarifications or call-outs.



A light bulb symbol indicates suggested manufacturer tips for the user to get the most out of the Durastar equipment and to accommodate the best user experience.

IMPORTANT SAFETY PRECAUTIONS

Improper handling can cause serious damage or injury. Please read the following safety information in its entirety.



Operation, Cleaning, and Maintenance Safety Precautions

- Children and people with reduced physical, sensory, or mental capabilities, or lack of experience and knowledge, should only use this air conditioner if they are given supervision or instructions concerning use of the air conditioner in a safe way and understand the hazards involved.
- Children should not play with the air conditioner.
- Never stick fingers or any other body parts into the air conditioner openings. The internal fan may be rotating at high speeds, and may result in injury.
- After removing the filter, do not touch the fins in order to avoid injury.
- Maintenance must be performed by qualified professionals. Otherwise, you may experience personal injury or damage to the air conditioner and surrounding property.
- Do not repair the air conditioner by yourself. It may cause electric shock or damage. Please contact a qualified service representative when you need to repair the air conditioner.
- Do not block the air outlet or air inlet. This could cause a malfunction.
- Do not spill water on the wired thermostat as this can permanently damage the controls.
- If the below problems occur, please turn off the air conditioner and disconnect power at the circuit breaker immediately. Then contact your dealer or a qualified professional for service.
 - The power cord is overheating or damaged.
 - There is an abnormal sound during operation.
 - The circuit breaker trips frequently.
 - The air conditioner gives off a burning smell.
 - The indoor unit is leaking.
- If the air conditioner operates under abnormal conditions, it may cause malfunctions, electric shock, or fire hazard.
- When turning the unit on or off via the emergency operation switch, press the switch with an insulated object other than metal.
- Do not step on the top panel of the unit, or put heavy objects on the top panel. This could cause damage or personal injury.
- Cleaning and user maintenance should not be performed by children without supervision.
- Do not spray water on the indoor unit. This could cause electric shock or a unit malfunction.
- Do not use flammable materials such as hair spray, lacquer, or paint near the air conditioner as they may catch fire.
- Do not operate the air conditioner in places near combustible gases. Emitted gases may collect around the air conditioner and cause an explosion.
- Do not use fire or a hair dryer to dry the filter. This could cause a deformation or fire hazard.
- Do not wash the air conditioner with water as this could cause an electric shock.
- Disconnect the power supply by turning it off at the circuit breaker when cleaning the air conditioner. Otherwise, you could risk electric shock.



Electrical Safety

- Only use the specified power cord. If the power cord is damaged, it must be replaced by the manufacturer, its service agent, or similarly qualified persons in order to avoid a hazard.
- Keep the power plug clean. Remove any dust or grime that accumulates on or around the plug. Dirty plugs can cause fire or electric shock.
- Do not pull the power cord to unplug unit. Hold the plug firmly and pull it from the outlet. Pulling directly on the cord can damage it, which can lead to fire or electric shock.
- Do not connect the air conditioner to a multi-purpose socket. Doing so could cause a fire hazard.
- Do not modify the length of the power supply cord or use an extension cord to power the unit.
- If the supply cord is damaged, it must be replaced by the manufacturer, a service agent, or a similarly qualified person in order to avoid a safety hazard.
- Do not share the electrical outlet with other appliances. Improper or insufficient power supply can cause fire or electrical shock.
- The product must be properly grounded at the time of installation, or electrical shock may occur.
- For all electrical work, follow all local and national wiring standards and regulations. Connect cables tightly, and clamp them securely to prevent external forces from damaging the terminal. Improper electrical connections can overheat and cause fire, and may also cause shock. All electrical connections must be made according to the Electrical Connection Diagram located on the panels of the indoor and outdoor units.
- All wiring must be properly arranged to ensure that the control board cover can close properly. If the control board cover is not closed properly, it can lead to corrosion and cause the connection points on the terminal to heat up, catch fire, or cause electrical shock.
- The air conditioner's circuit board (PCB) is designed with a fuse to provide overcurrent protection. The specifications of the fuse are printed on the circuit board.



Installation Safety

- Installation must be performed by an authorized dealer or specialist. Improper installation can cause water leakage, electrical shock, or fire. (In North America, installation must be performed in accordance with NEC and CEC requirements by authorized personnel only.)
- Installation must be performed according to the installation instructions. Improper installation can cause water leakage, electrical shock, or fire.
- This air conditioner shall be installed in accordance with national and local wiring regulations.
- Contact an authorized service technician for repair or maintenance of this unit.
- Only use the included accessories, parts, and specified parts for installation. Using non-standard parts can cause water leakage, electrical shock, fire, and can cause the unit to fail.
- Install the unit in a firm location that can support the unit's weight. If the chosen location cannot support the unit's weight, or the installation is not done properly, the unit may fall and cause serious injury and damage.
- Install drainage piping according to the instructions in the installation manual. Improper drainage may cause water damage to your home and property.
- For units that have an auxiliary electric heater, do not install the unit within 1 meter (3 feet) of any combustible materials.
- Do not install the unit in a location that may be exposed to combustible gas leaks. If combustible gas accumulates around the unit, it may cause a fire.
- Do not turn on the power until all work has been completed.
- When moving or relocating the air conditioner, consult experienced service technicians for disconnection and reinstallation of the unit.



Additional Precautions

- Turn off the air conditioner and disconnect the power if you are not going to use it for a long time.
- Turn off and unplug the unit during storms.
- Make sure that water condensation can drain unhindered from the unit.
- Do not operate the air conditioner with wet hands. This may cause electric shock.
- Do not use this device for any other purpose than its intended use.
- Do not climb onto or place objects on top of the outdoor unit.
- Do not allow the air conditioner to operate for long periods of time with doors or windows open, or if the humidity is very high.

PARTS IDENTIFICATION

INDOOR UNIT

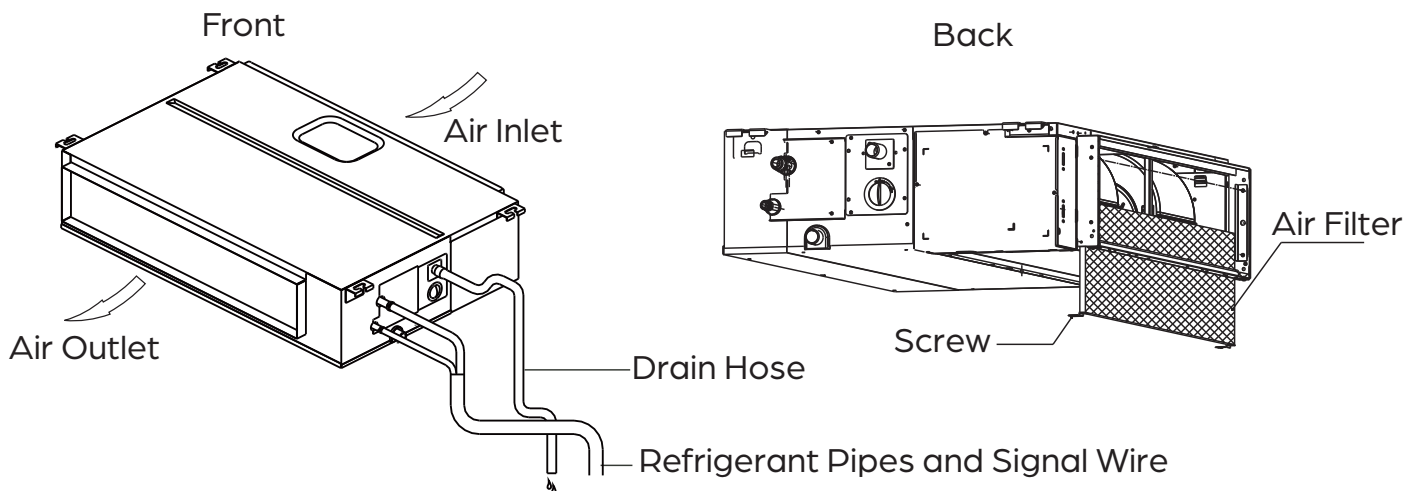

OUTDOOR UNIT

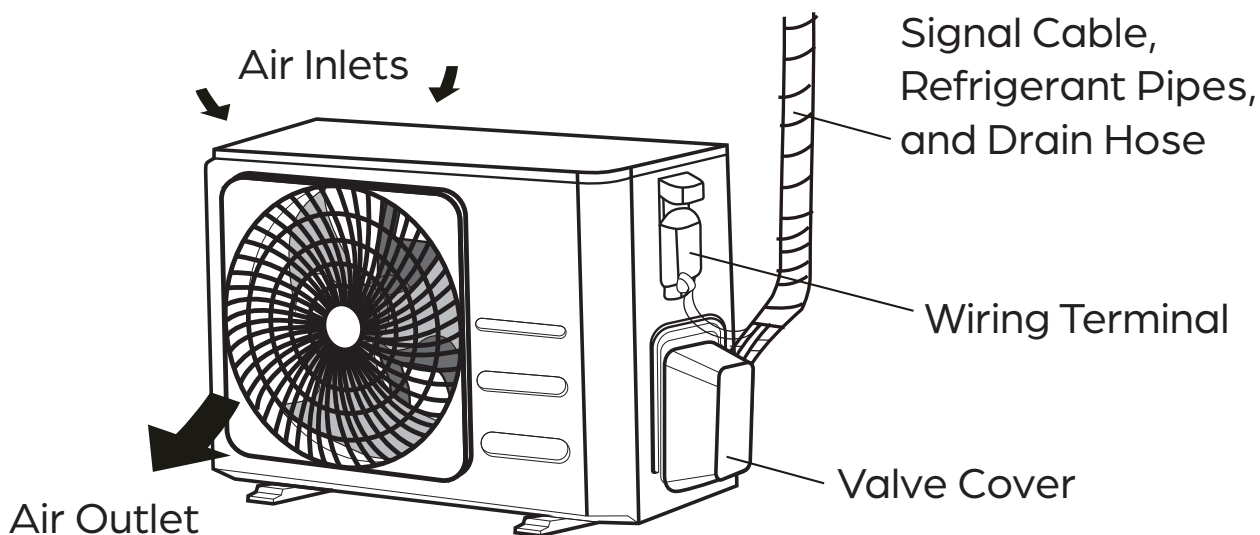







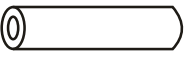

NOTE

Outdoor units may vary in appearance.

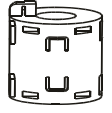
INCLUDED ACCESSORIES

The air conditioning system comes with the following accessories.

Accessory	Quantity	Image	Accessory	Quantity	Image
Manual	1-2		Display Panel	1	
Soundproof Insulation Sheath	1		Wired Thermostat	1	
Cord Protector	1		Magnetic Ring (Some Models)	1	
Drain Pipe Adapter	1		Drain Pipe Worm Clamp	2	
Copper Nut	2				

OPERATING TEMPERATURES

Your air conditioner is designed to operate in the following indoor and outdoor temperatures. When your air conditioner is used outside of the following temperature ranges, certain safety features may activate and turn off the unit to protect it from damage.

TEMPERATURE RANGES

	COOL Mode	HEAT Mode	DRY Mode
Indoor Air Temperature	62°F - 90°F (17°C - 32°C)	32°F - 86°F (0°C - 30°C)	50°F - 90°F (10°C - 32°C)
Outdoor Air Temperature	-13°F - 122°F (-25°C - 50°C)	-13°F - 86°F (-25°C - 30°C)	32°F - 122°F (0°C - 50°C)

To further optimize the performance of your unit, do the following:

- Keep doors and windows closed.
- Limit energy usage by using TIMER ON and TIMER OFF features.
- Do not block air inlets or outlets.
- Regularly inspect and clean air filters.

NOTE



Your Durastar air conditioner's outdoor unit is equipped with a base pan heater, allowing it to continue to operate at freezing temperatures as low as -13°F (-25°C). When outdoor air temperatures are at or below 32°F (0°C), we strongly recommend keeping the unit plugged in at all times to ensure smooth ongoing performance.

NOTE



Keep the room's relative humidity below 80%. If the air conditioner operates in excess of this, the surface of the air conditioner may attract condensation. To help prevent condensation from forming and dripping, set the vertical airflow louver to its maximum angle (vertically to the floor) and set the fan to HIGH.

WIRED THERMOSTAT

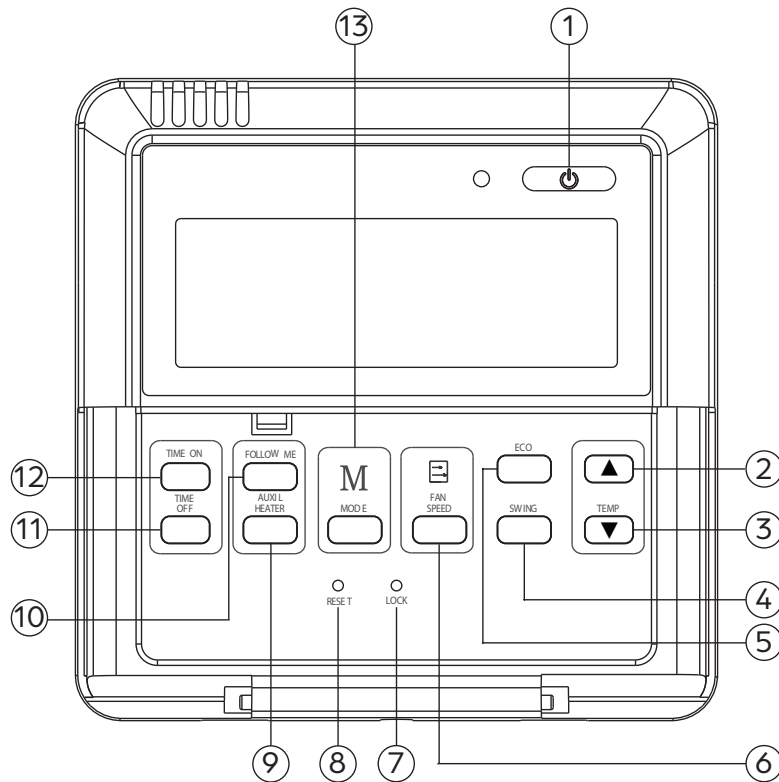

1. ON/OFF Button
Press to turn the air conditioner ON and OFF.

2. UP Button ▲
Press to increase the set temperature in 1°F / 1°C increments.

3. DOWN Button ▼
Press to decrease the set temperature in 1°F / 1°C increments.

4. SWING Button
Function is not available for this model.

5. ECO Button
For details on ECO mode, see the ECO feature section of this manual.

6. FAN SPEED Button
Press to select the following fan speeds:

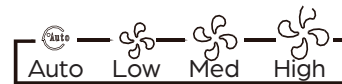

7. LOCK Button
Used to lock/unlock the thermostat settings.

8. RESET Button
Used to restore the system to its default settings.

9. AUXILIARY ELECTRICAL HEATER BUTTON
For use with third party electrical heaters. Not included with this unit.

10. FOLLOW ME Button
For details, see the FOLLOW ME feature section of this manual.

11. TIME OFF Button
Press to initiate the TIMER OFF feature. For details, see the TIMER feature section of this manual.

12. TIME ON Button
Press to initiate the TIMER ON feature. For details, see the TIMER feature section of this manual.

13. MODE Button
Press to select the operating mode. AUTO → COOL → DRY → HEAT → FAN



NOTE

Press the Temp Up and Down buttons (#2 & #3) simultaneously to switch between Fahrenheit and Celsius (some models).

**NOTE**

The FAN speed cannot be adjusted in AUTO or DRY Mode.

**NOTE**

Press and hold the UP and DOWN buttons simultaneously for 3 seconds to switch between F and C.

OPERATING MODES

SETTING TEMPERATURE

This unit can be set at any temperature between 62 and 86°F (17-30°C) in cool, heat, and dry modes. You can increase or decrease the set temperature in 1°F (1°C) increments using the TEMP up (▲) or TEMP down (▼) button.

AUTO

In AUTO mode, the unit will automatically select the COOL, FAN, HEAT, or DRY modes to maintain the set temperature.

1. Press the MODE button and select AUTO.
2. Set your desired temperature using the TEMP down or TEMP up button.
3. Press the ON/OFF button to start the unit.

COOL

1. Press the MODE button and select COOL.
2. Set your desired temperature using the TEMP down or TEMP up button.
3. Press the FAN SPEED button to select the fan speed: AUTO, LOW, MED or HIGH.
4. Press the ON/OFF button to start the unit.

FAN

1. Press the MODE button and select FAN.
2. Press the FAN SPEED button to select the fan speed: AUTO, LOW, MED or HIGH.
3. Press the ON/OFF button to start the unit.

**NOTE**

You cannot adjust the temperature in FAN mode. As a result, your thermostat's LCD display will not display a temperature.

DRY (DEHUMIDIFY)

1. Press the MODE button and select DRY.
2. Set your desired temperature using the TEMP down or TEMP up button.
3. Press the ON/OFF button to start the unit.

HEAT

1. Press the MODE button and select HEAT.
2. Set your desired temperature using the TEMP down or TEMP up button.
3. Press FAN button to select the fan speed: AUTO, LOW, MED or HIGH.
4. Press the ON/OFF button to start the unit.



NOTE

As outdoor temperature drops, the performance of your unit's HEAT function may be affected.



NOTE

Two or more indoor units can be operated by one outdoor unit. However, two or more indoor units cannot operate simultaneously when different operating modes have been selected. If COOL/DRY/FAN is selected with one or more indoor units and HEAT with another, the unit(s) in HEAT has priority.

ADVANCED FEATURES

TIMER

The TIMER feature establishes the amount of time that will elapse before the unit will automatically turn on/off.

Press the TIMER ON button to initiate the auto-on time sequence. Each subsequent press of this button will increase the setting in 30 minute increments up to 10 hours. Once the setting time displays 10.0, each additional press will increase the setting in 60 minute increments. To cancel the auto-timed program, simply adjust the timer to 0.0.

Press the TIMER OFF button to initiate the auto-off time sequence. Each subsequent press of this button will increase the setting in 30 minute increments up to 10 hours. When the setting time displays 10.0, each additional press will increase the setting in 60 minute increments. To cancel the auto-timed program, simply adjust the timer to 0.0.

TIMER ON and OFF setting example.

Keep in mind that the time periods you set for both the on and off feature refers to hours after the current time.

If the current time is 1:00 PM and the TIMER ON setting is adjusted to 2.5 hours, the auto-on time sequence will turn the air conditioner on 2.5 hours later at 3:30 PM. Setting the TIMER OFF auto-off sequence to 5.0 hours will turn off the air conditioner 5 hours later at 6:00 PM.

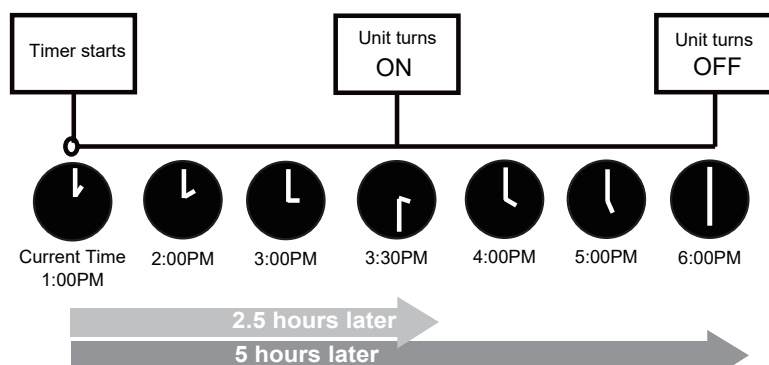

ECO

The ECO feature is designed to decrease energy use while you sleep. This feature can only be activated by the wired thermostat. The ECO feature is not available in FAN or DRY mode.

Press the ECO button when you are ready to go to sleep. When in COOL mode, the unit will increase the temperature by 2°F (1°C) after 1 hour, and will increase an additional 2°F (1°C) after another hour. When in HEAT mode, the unit will decrease the temperature by 2°F (1°C) after 1 hour, and will decrease an additional 2°F (1°C) after another hour.

The ECO feature will turn off after 8 hours and the system will return to normal functioning.

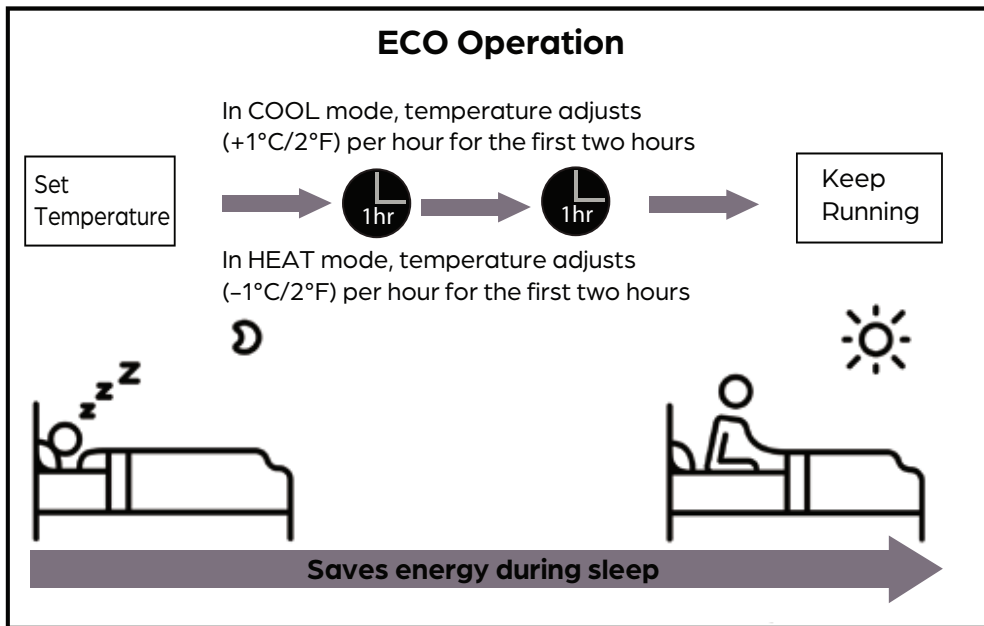

FOLLOW ME

This feature uses the temperature at the thermostat's location, instead of the indoor unit's location, to optimize the temperature around you and ensure maximum comfort. Press the FOLLOW ME button to turn on this feature and the thermostat will display the temperature at its location. When using AUTO, COOL, and HEAT modes the air conditioner will continue running until the temperature at the thermostat's location is satisfied. Press the FOLLOW ME button again to turn off this feature.

AUTO-RESTART

The auto-restart feature is enabled when power is interrupted to the unit. After power is restored, the unit will automatically return to its prior settings before power was lost. No buttons need to be pressed to set this feature - it is automatic.

LED DISPLAY INDICATORS

The following is a list of possible indicators that may appear on the indoor unit's display panel. Not all the display indicators may be available on the unit purchased.

Feature	Indicator	Notes
TIMER ON, SWING, TURBO, SILENCE	ON	Displays for 3 seconds when the TIMER ON feature is set or the SWING, TURBO, or SILENCE feature is turned on. If the unit is off, ON will continue to be shown if the TIMER ON feature is set.
TIMER OFF, SWING, TURBO, SILENCE	OF	Displays for 3 seconds when the TIMER OFF feature is set or the SWING, TURBO, or SILENCE feature is turned off.
SELF CLEAN	SC	Displays when the SELF CLEANING feature is on.
FP	FP	Displays when the FP feature is on.
FORCED COOLING	FC	Displays when the FORCED COOLING mode is selected with the manual control button. See Manual Operation section.
ANTI-COLD AIR FLOW	cF	The unit is designed not to blow cold air in HEAT mode. When HEAT mode is selected the unit will display "cF" until the set temperature is reached and the unit can blow warm air.
DEFROST	dF	Displays when unit is defrosting. This may last 5-10 minutes depending on the outdoor temperature and the amount of frost buildup on the outside unit.

MANUAL OPERATION (USE WITHOUT THERMOSTAT)

The manual override button is intended for testing purposes and emergency operation. Please do not use this button unless the wired thermostat is unresponsive and it is absolutely necessary. The unit must be turned off before manual operation.

To operate your unit manually:

1. Locate the MANUAL button on the display panel of the unit.
2. Press the MANUAL button one time to activate FORCED AUTO mode.
3. Press the MANUAL button again to activate FORCED COOLING mode.
4. Press the MANUAL button a third time to turn the unit off.

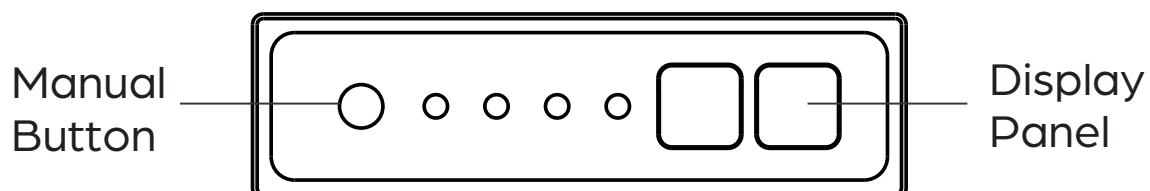

CARE AND MAINTENANCE



CAUTION

- Always turn off the unit and disconnect power before cleaning or maintenance.
- Only use a soft, dry cloth to wipe the unit clean. If the unit is especially dirty, you can use a cloth soaked in warm water to wipe it clean.

CLEANING INDOOR UNIT

- Do not use chemicals or chemically treated cloths to clean the unit.
- Do not use benzene, paint thinner, polishing powder or other solvents to clean the unit. They can cause the plastic surface to crack or deform.
- Do not use water hotter than 104°F (40°C) to clean the front panel. This can cause the panel to deform or become discolored.

CLEANING THE AIR FILTER

A dirty air filter can reduce the cooling efficiency of your unit, and can also be bad for your health. Make sure to clean the filter once every two weeks.

1. Remove the screw holding the air filter in place.
2. Remove the air filter.
3. Clean the air filter by gently vacuuming the surface or washing it in warm water with a mild detergent.
4. Rinse the filter with clean water and allow it to air dry. Do not dry the filter in direct sunlight.
5. Reinstall the air filter.
6. Reinstall the screw.

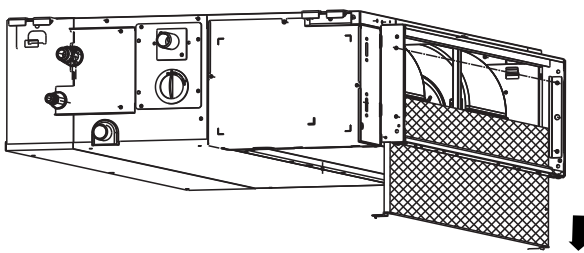

If using water, the inlet side should face down and away from the water stream.

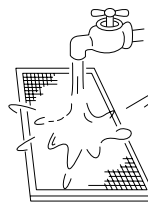

If using a vacuum cleaner, the inlet side should face the vacuum.

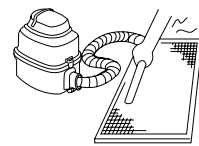

CAUTION

- Before changing the filter or cleaning, turn off the unit and disconnect its power supply.
- When removing the filter, do not touch the metal parts in the unit. The sharp metal edges can cut you.
- Do not use water to clean the inside of the indoor unit. This can destroy insulation and cause electrical shock.
- Do not expose filter to direct sunlight when drying. This can shrink the filter.

MAINTENANCE – LONG PERIODS OF NON-USE

If you do not plan to use your air conditioner for an extended period of time, do the following:

- Clean all filters.
- Turn on the FAN until the unit dries out completely.
- Turn off the unit and disconnect the power.

MAINTENANCE – PRE-SEASON INSPECTION

After long periods of non-use, or before periods of frequent use, do the following:

- Inspect for damaged wires
- Clean all filters.
- Check for leaks.
- Replace batteries.
- Make sure nothing is blocking any air inlets or outlets.

TROUBLESHOOTING

SAFETY PRECAUTIONS

If ANY of the following conditions occurs, turn off your unit immediately!

- The power cord is damaged or abnormally warm
- You smell a burning odor
- The unit emits loud or abnormal sounds
- A power fuse blows or the circuit breaker frequently trips
- Water or other objects fall into or out of the unit

DO NOT ATTEMPT TO FIX THESE YOURSELF! CONTACT AN AUTHORIZED SERVICE PROVIDER IMMEDIATELY!

COMMON ISSUES

The following problems are not a malfunction and in most situations will not require repairs.

ISSUE	POSSIBLE CAUSES
Unit does not turn on when pressing ON/OFF button	The unit has a 3-minute protection feature that prevents the unit from overloading. The unit cannot be restarted within three minutes of being turned off.
The unit changes from COOL/HEAT mode to FAN mode	The unit may change its setting to prevent frost from forming on the unit. Once the temperature increases, the unit will start operating in the previously selected mode again.
	The set temperature has been reached, at which point the unit turns off the compressor. The unit will continue operating when the temperature fluctuates again.
The indoor unit emits white mist	In humid regions, a large temperature difference between the room's air and the conditioned air can cause white mist.
Both the indoor and outdoor units emit white mist	When the unit restarts in HEAT mode after defrosting, white mist may be emitted due to moisture generated during the defrosting process.
The indoor unit makes noises	A rushing air sound may occur when the louver resets its position.
	A squeaking sound may occur after running the unit in HEAT mode due to expansion and contraction of the unit's plastic parts.

ISSUE	POSSIBLE CAUSES
Both the indoor unit and outdoor unit make noises	Low hissing sound during operation: This is normal and is caused by refrigerant gas flowing through both indoor and outdoor units.
	Low hissing sound when the system starts, has just stopped running, or is defrosting: This noise is normal and is caused by the refrigerant gas stopping or changing direction.
	Squeaking sound: Normal expansion and contraction of plastic and metal parts caused by temperature changes during operation can cause squeaking noises.
The outdoor unit makes noises	The unit will make different sounds based on its current operating mode.
Dust is emitted from either the indoor or outdoor unit	The unit may accumulate dust during extended periods of non-use, which will be emitted when the unit is turned on. This can be mitigated by covering the unit during long periods of inactivity.
The unit emits a bad odor	The unit may absorb odors from the environment (such as furniture, cooking, cigarettes, etc.) which will be emitted during operations.
	The unit's filters have become moldy and should be cleaned.
The fan of the outdoor unit does not operate	During operation, the fan speed is controlled to optimize product operation.
Operation is erratic, unpredictable, or unit is unresponsive	Interference from cell phone towers and remote boosters may cause the unit to malfunction. In this case, try the following: <ul style="list-style-type: none"> • Disconnect the power, then reconnect. • Press ON/OFF button on the thermostat to restart operation.

NOTE



If problem persists, contact a local dealer or your nearest customer service center. Provide them with a detailed description of the unit malfunction as well as your model number.

TROUBLESHOOTING

When troubles occurs, please check the following points before contacting a repair company.

PROBLEM	POSSIBLE CAUSES	SOLUTION
Poor cooling performance	Temperature setting may be higher than ambient room temperature	Lower the temperature setting
	The heat exchanger on the indoor or outdoor unit is dirty	Clean the affected heat exchanger
	The air filter is dirty	Remove the filter and clean it according to instructions
	The air inlet or outlet of either unit is blocked	Turn the unit off, remove the obstruction and turn it back on
	Doors and windows are open	Make sure that all doors and windows are closed while operating the unit
	Excessive heat is generated by sunlight	Close windows and curtains during periods of high heat or bright sunshine
	Low refrigerant due to leak or long-term use	Check for leaks, re-seal if necessary and top off refrigerant
	Too many sources of heat in the room (people, computers, electronics, etc.)	Reduce amount of heat sources
Poor heating performance	The outdoor temperature is extremely low	Use auxiliary heating device
	Cold air is entering through doors and windows	Make sure that all doors and windows are closed during use
	Low refrigerant due to leak or long-term use	Check for leaks, re-seal if necessary and top off refrigerant
The unit starts and stops frequently	There's too much or too little refrigerant in the system	Check for leaks and recharge the system with refrigerant
	Incompressible gas or moisture has entered the system	Evacuate and recharge the system with refrigerant
	The compressor is broken	Replace the compressor
	The voltage is too high or too low	Install a manostat to regulate the voltage
Indicator lamps continue flashing or error code appears	<p>The unit may stop operation or continue to run safely. If the indicator lamps continue to flash or error codes appear, wait for about 10 minutes. The problem may resolve itself.</p> <p>If not, disconnect the power, then connect it again. Turn the unit on.</p> <p>If the problem persists, disconnect the power and contact your nearest customer service center.</p>	

PROBLEM	POSSIBLE CAUSES	SOLUTION
The unit is not working	Power failure	Wait for the power to be restored
	The power is turned off	Turn on the power
	The fuse is burned out	Replace the fuse
	The unit's 3-minute protection has been activated	Wait three minutes after restarting the unit
	Timer is activated	Turn timer off

**NOTE**

If your problem persists after performing the checks and diagnostics above, or the error code remains, turn off your unit immediately and contact an authorized service center.

LIMITED WARRANTY – PARTS

TEN (10) YEARS PARTS

Subject to all of the terms of this Limited Warranty, including, but not limited to, the specific exclusions set forth below and subject to the Manufacturer's right to inspect and validate the warranty claim as set forth below, Manufacturer will repair or replace, at its option, ANY PART of Covered Equipment that is found to be defective in materials or workmanship. If an exact replacement part is not available, an equivalent part or credit will be provided.

The parts are warranted for a period of ten (10) years to the original owner of the mini-split equipment under normal use and service. For a period of ten (10) years from the date of installation, if any parts prove defective due to improper workmanship and/or material, Durastar will replace any defective part without charge for the part. Replacement parts carry the balance of the original 10-year parts warranty.

To qualify:

- The mini-split equipment must be installed in a residential single-family home.*
- The original mini-split equipment owner must reside in the single-family home.
- The mini-split equipment must be properly installed. This includes installation by a contractor licensed for HVAC installation following all local and state laws.
- Any part to be replaced must be made available in exchange for the replacement.

*Single-family home is defined as any single-family dwelling, which includes apartments, condominiums, duplexes, and homes.

EFFECTIVE DATE OF WARRANTY

The Effective Date of warranty coverage is determined as follows: (a) If the original installation date can be verified by the installer's invoice then the Effective Date of warranty coverage is the original installation date as shown on the installer's invoice. For residential new construction installations, the final occupancy permit, or proof of purchase from the builder can be substituted for the installer's invoice. (b) if the original installation date cannot be verified by the installer's invoice, or proof of purchase from the builder in residential new construction applications, then the Effective Date of warranty coverage is the Covered Equipment's manufacture date (as verified by the product's serial number) plus ninety (90) days.

There is NO LABOR component provided with this warranty. This Limited Warranty does NOT cover any labor costs or expenses for service, NOR for removing or reinstalling parts. You are responsible for all labor costs or expenses, unless a labor service agreement exists between you and your contractor.

This Limited Warranty does NOT cover shipping costs. You are responsible for the cost of shipping warranty replacement parts from our factory to the Manufacturer's distributor and from the distributor to the location of your Covered Equipment. You also are responsible for the cost of shipping failed parts to the distributor and for incidental costs incurred locally, including handling charges. (If in Alaska, Hawaii or Canada, you also must pay the shipping costs of returning the failed part to the port of entry into the continental United States.)

EXCLUSIONS

In addition to the other exclusions identified in this Limited Warranty, this Limited Warranty excludes:

- Damages, malfunctions, or failures resulting from failure to properly install, operate, or maintain Covered Equipment in accordance with the Manufacturer's instructions.
- Damages, malfunctions, or failures resulting from misuse, accident, contaminated, or corrosive atmosphere, vandalism, freight damage, fire, flood, freeze, lightning, acts of war, acts of God and the like.
- Parts installed with Covered Equipment or used in connection with normal maintenance, such as cleaning or replacing air filters, refrigerant, thermostats, tubing, or concrete pads.
- Covered Equipment that is not installed in the United States.

- Covered Equipment that is not installed by a qualified, trained HVAC professional in accordance with applicable codes, ordinances, and good trade practices.
- Damages, malfunctions, or failures resulting from the use of any attachment, accessory, or component not authorized by the Manufacturer or resulting from alteration or modification of the unit.
- Covered Equipment moved from the original installation location.
- Covered Equipment when operated with system components (indoor unit, outdoor unit, coil, and refrigerant control devices) or accessories which do not match or meet the specifications recommended by the Manufacturer.
- Any Covered Equipment manufactured that has been sold to the consumer via the Internet or auction website, and has not been installed by a trained, qualified HVAC professional.
- Covered Equipment that is not part of a properly matched system as specified by the Air Conditioning, Heating & Refrigeration Institute (AHRI).

COMMERCIAL WARRANTY

Installations in commercial applications carry a ONE (1) YEAR PARTS warranty following the other provisions in this Limited Warranty.

OBTAINING WARRANTY SERVICE

If you believe your product is defective, contact the licensed contractor who installed your mini-split system. Alternatively, contact a licensed contractor, dealer, or distributor.

Durastar Customer Support is available for troubleshooting assistance. Before contacting Customer Support, please locate your model number, serial number, and proof of purchase. These items will be required to complete any warranty service. A Durastar authorized representative will verify warranty eligibility and determine appropriate service options. Service will be provided during normal business days and hours.

THIS WARRANTY IS IN LIEU OF ANY OTHER WARRANTY, EXPRESS OR IMPLIED, INCLUDING WITHOUT LIMITATION, ANY WARRANTY OF MERCHANTABILITY OR FITNESS FOR A PARTICULAR PURPOSE. TO THE EXTENT ANY IMPLIED WARRANTY IS REQUIRED BY LAW, IT IS LIMITED IN DURATION TO THE EXPRESS WARRANTY PERIOD ABOVE. NEITHER THE MANUFACTURER NOR ITS DISTRIBUTORS SHALL BE LIABLE FOR ANY INCIDENTAL, CONSEQUENTIAL, INDIRECT, SPECIAL, OR PUNITIVE DAMAGES OF ANY NATURE, INCLUDING WITHOUT LIMITATION, LOST REVENUES OR PROFITS, OR ANY OTHER DAMAGE WHETHER BASED IN CONTRACT, TORT, OR OTHERWISE. IN NO EVENT AND UNDER NO CIRCUMSTANCE OF ANY TYPE OR KIND SHALL THE SELLER, MANUFACTURER AND/OR DISTRIBUTOR BE LIABLE FOR ANY REASON, UNDER ANY THEORY, FOR MORE THAN THE BASIC COST OF THE PRODUCT TO THE PURCHASER OR END USER. SOME STATES DO NOT ALLOW THE EXCLUSION OF INCIDENTAL OR CONSEQUENTIAL DAMAGES, SO THE ABOVE EXCLUSION MAY NOT APPLY TO YOU. THIS WARRANTY GIVES YOU SPECIFIC LEGAL RIGHTS. YOU MAY HAVE OTHER RIGHTS THAT VARY FROM STATE TO STATE.

THIS PAGE INTENTIONALLY LEFT BLANK.

