

CARE AND MAINTENANCE

- * Dust the vanity regularly with soft, non-lint producing cloth or household dusting products.
- * You can clean the vanity with a gentle, non-abrasive household cleaner.
- * Make sure to dry the wood immediately with a soft cloth/towel.
- * The ceramic sink can be cleaned using standard ceramic cleaning agents available at your local supplier.
- * Small scratches and some damage happen during the use's period. Ask your contractor for a bottle touch-up painting, you can fix it by yourself.

IMPORTANT

- * Shade variations and patterns are an inherent characteristic of stone (e.g. granite, marble, engineered stone). Stone tops will vary from product to product. Use caution placing items such as soap or any fragranced material on the stone surface. Use a soap dish, coaster or similar item to protect the surface if placing any soap or fragranced products on the stone.
- * If soap or fragranced products come in contact with stone top, rinse the surface with water and dry using a soft non-abrasive cloth.
- * **WARNING:** Must use cleaning agents safe for stone. Check your cleaning agents use restrictions before using on any stone. Damage to the stone may result. Vanity manufacturer not responsible for damage caused by improper cleaning agent or soap used. Warranty will not cover damage caused by improper soap or cleaning agents.
- * **DO NOT** use products to clean the stone top that contain acetone, lemon, vinegar or other acids as these may cause damage to the stone surface
- * Periodically reseal the stone top using an appropriate stone sealer available from your local store. Follow the manufacturer's directions on How to apply.

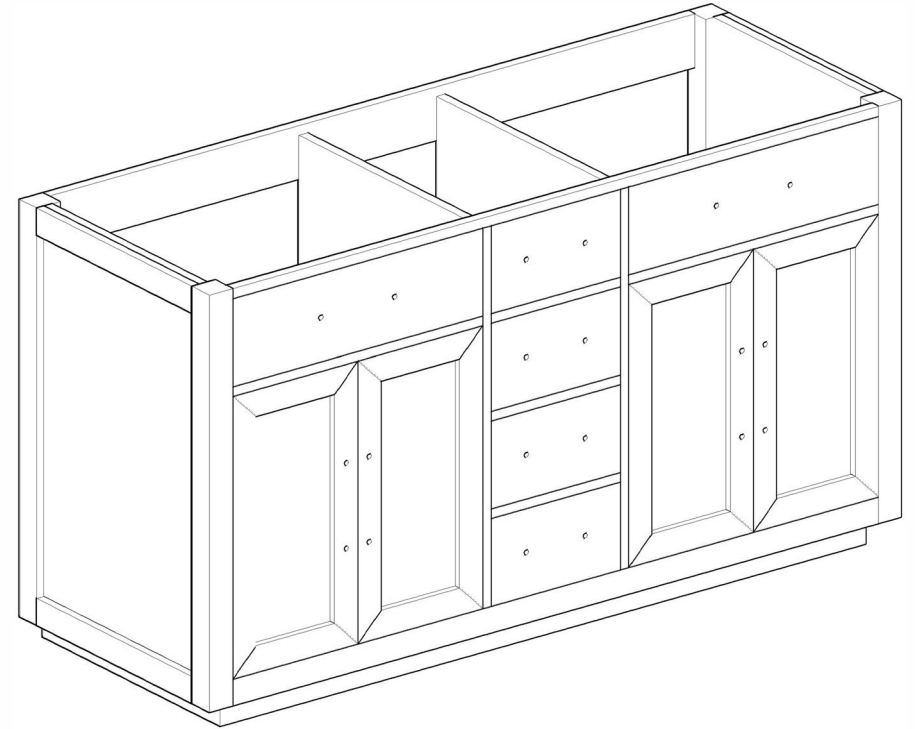

MODEL NO.:VFDX602234S

Bathroom Vanity Installation

Tools requested not in box



Step1: Open the cabinet box, place the cabinet base on the right position, level the cabinet with the leg levelers.

Step2: Apply bead of quality and clear or white silicone sealant evenly along the top of the cabinet

Step3: Place the counter top onto the cabinet.

Step4: Apply silicone sealant evenly along the bottom of backsplash and wall

Step5: Finally, place the bottom side of backsplash with sealant onto the countertop and check the alignment of back backsplash
Adjust the leg levelers as needed.

Adjustment of hinges

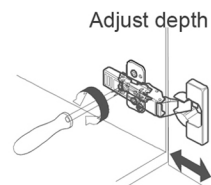
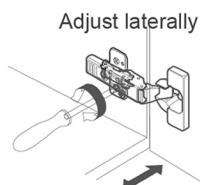
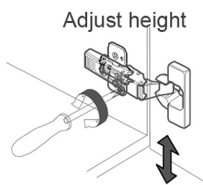

TECHNICAL DRAWING

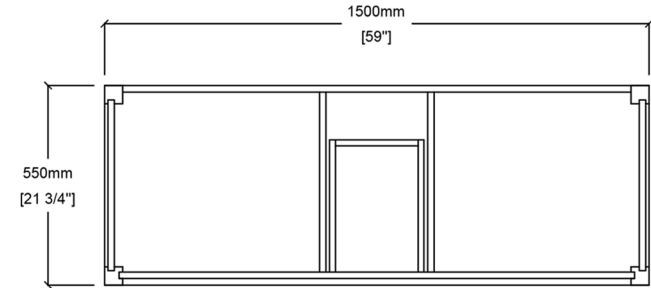

TOP VIEW

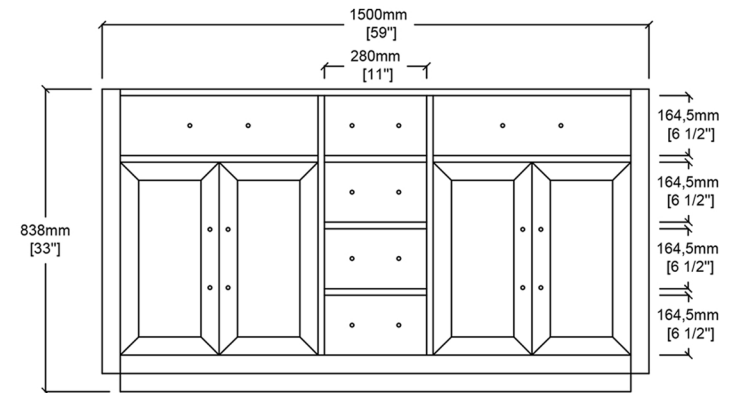

FRONT VIEW

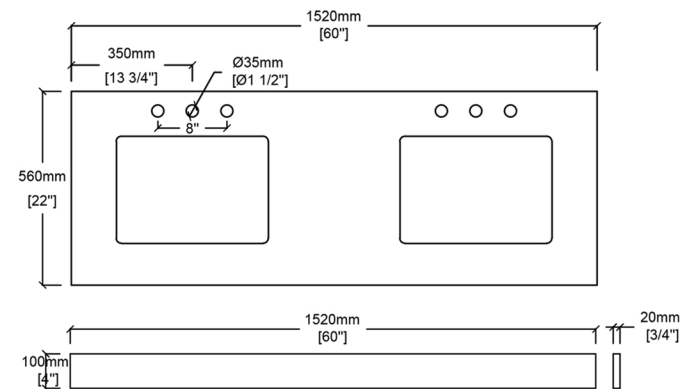

COUNTER-TOP

Solid Wood Construction Bathroom Vanity