

# Docking Drawer®

Blade Series Tear Sheet

**BLADE 1514-160**

Revision 2



Docking Drawer is the market leader of in-drawer outlets, offering the only ETL Listed solution unsurpassed in both safety and quality.

Designed intentionally for use inside a drawer, our outlets feature an integrated thermostat that cuts power if surrounding temperatures exceed 120°F and cable management arms that guide and protect the power cord as the drawer opens and closes. Premium, all-metal components guarantee long-lasting durability, while the capacity to easily update the outlet as technology changes over time ensures lifelong usability.

Install our in-drawer outlets with ease into drawers of any type to eliminate cord and device clutter from countertops and surfaces for more organized and functional spaces.

# Blade Series Blade 1514-160

## Outlet Dimensions

Outlet Width	13" (330mm)
Outlet Height	4.64" (118mm)
Outlet Depth	2.5" (64mm)
Receptacle Box Depth	1.93" (49mm)
Cover Plate Height	2.52" (64mm)
Cover Plate Width	7.18" (182mm)
Cord Length	42" (1.07mm)

### Front View

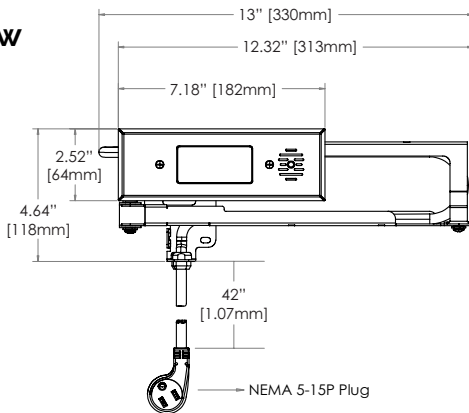

### Top View

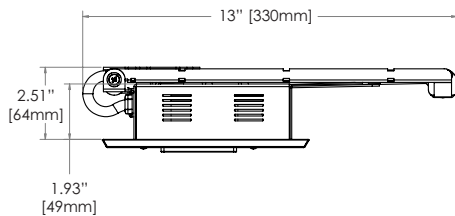

## Outlet Specifications



15 amps @ 120 VAC

2 AC

## Recommended Locations for the In-Cabinet Electrical Supply



*Do NOT put the electrical supply directly behind the drawer box as it may interfere with the cable management arms*

- ETL Listed for use in the US and Canada
- Certified to UL 962A (US)
- Certified to CSA C22.2 No. 21 (CA)



## Cabinet Specifications

	Shallow Drawer	Tall Drawer	Narrow Drawer	Vertical Drawer
Minimum Drawer Width (OD)	15" or more	13" or more	9" or more	8" or more
Minimum Interior Drawer Box Height	3" or more	4" or more	4" or more	13" or more

## Resources & Downloads

Docking Drawer provides all of the necessary resources to plan a Blade Series outlet installation. Download the following resources at [dockingdrawer.com/downloads](http://dockingdrawer.com/downloads):

- Spec Book
- DXF, Step and Solidwork Files
- Mounting Diagrams
- Installation Instructions

## Ready to Order?

Source directly from Docking Drawer or from one of our distribution partners. [Learn more.](#)

Project Name:

Where to Source:  Docking Drawer  Distributor

Lead Time - 2 weeks    Freight - FOB San Ramon    Warranty - 5 Years    [Terms & Conditions](#)