



IgniteXL™

74" Linear Electric Fireplace

XLF74

Designed to ignite
your passion.



IgniteXL™ stands apart as more lifelike and visually stunning than anything that came before it. With new, patented flame and heat technology, IgniteXL transforms the look and feel of any room. Installation is simpler and more flexible than ever, making the possibilities almost endless. Enjoy flawless panoramic views that ignite the senses from any angle.

IGNITE XL™











IgniteXL™

74" Linear Electric Fireplace

XLF74



Features

-  **Multi-Fire XD™ Flame Effect**
Vivid flames that are brighter and more lifelike day or night.
-  **Less Frame, More Flame**
Clean front face with minimal trim makes the dazzling flames the focal point.
-  **ComfortSaver™ Heating System**
Safe ceramic heat, plus 11% energy savings, warms up to 1,000 sq. ft.
-  **Media Accent Colors**
Choose from a variety of brilliant color themes or cycle through a range of colors using the custom mode, freezing on the hue of your choice.
-  **Edgeless Design**
Installs without trim to stone, brick and other solid finish materials; includes trim for drywall and tile surfaces.
-  **Precision Thermostat**
Electronic thermostat maintains room temperature within 1/2°C (1°F) for perfect comfort and increased energy efficiency.
-  **Built-in Touch Controls**
Settings and temperature display are hidden when not in use.
-  **Heat Boost**
Quickly warms a room by delivering maximum heat output for a pre-determined amount of time.
-  **Mood-maker Remote**
Customize the light color and intensity for a fireplace that reflects your personality.
-  **Seamless Installation**
Low-profile design fully recesses in 2" x 6" wall construction and 2" x 4" with optional trim. Hardwire using 120V or 240V for powerful heating.
-  **Cool-touch Glass**
Glass remains cool making it safe for children and pets in any location.

Color Themes



Accessories



74" Driftwood and River Rock Accessory Package (LF74DWS-KIT)



74" IgniteXL Trim Kit (XLFTRIM74)
Allows installation of IgniteXL in 2"x4" wall construction.
76-3/4" x 18-1/4" x 1-7/8"
(195.0 cm x 46.2 cm x 4.5 cm)

120 Volts | 1,500 Watts | 5,118 BTU
240 Volts | 2,500 Watts | 8,530 BTU

Model #	Description	Lbs / Kg	UPC	Wty. [†]	Carton Dimensions (WxHxD)		Cube	
					Inches	cm	ft ³	m ³
XLF74	74" IgniteXL Linear Electric Fireplace	121.9 / 55.3	781052 098756	2 yr.	80-3/8 x 21-1/4 x 12	204.2 x 54.0 x 30.5	11.9	0.34
LF74DWS-KIT	74" Driftwood and River Rock Accessory Kit	9.8 / 4.44	781052 102859		34-1/4 x 7-1/8 x 8-1/8	87.2 x 18.03 x 20.57	1.12	0.03
XLFTRIM74	74" IgniteXL™ Linear Electric Fireplace Trim Kit	10.45 / 4.8	781052 107977	1 yr.	80-1/2 x 3-3/4 x 6-7/8	204.5 x 9.3 x 17.5	1.18	0.03

Specifications, finishes and dimensions are subject to change. [†]Limited warranty. ©2017 Dimplex North America Limited.

SE-018-R02-091317

IgniteXL™

74" Linear Electric Fireplace

XLF74

Product Dimensions:

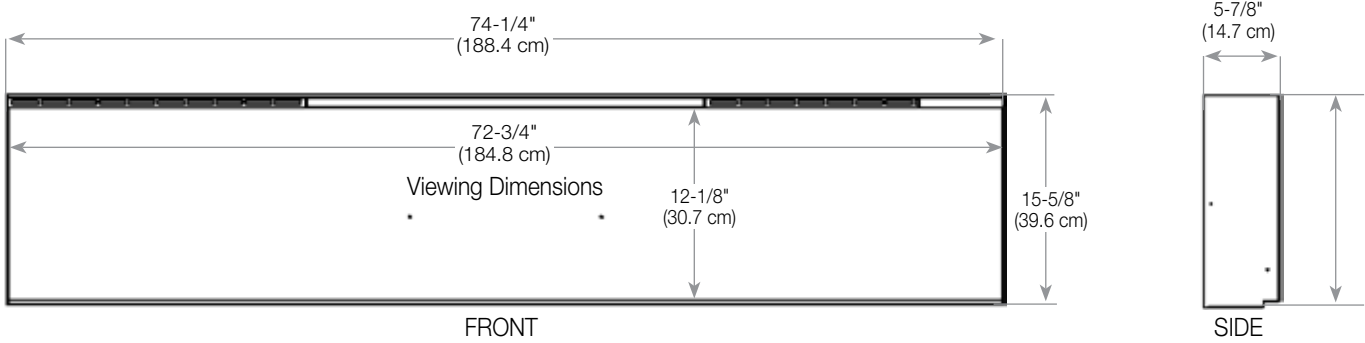

Framing Dimensions

NOTE: The bottom sill needs to be a minimum of 3-1/2" (8.9 cm) deep. The sill can be constructed to support the front of the unit to allow the power supply wires to easily be run behind or flush with the back of the unit and a pass through hole drilled for electrical wire routing.

It is recommended that the bottom of the unit be mounted between 30" (76.2 cm) and 40" (102 cm) from the ground to maintain an optimized viewing angle of the flame.

2x6 framing

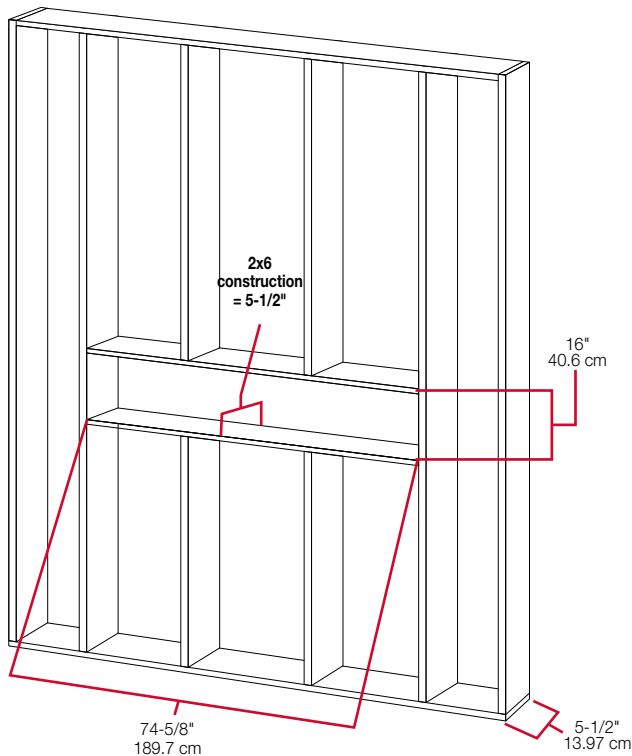

2x4 framing

