



Design House is a registered brand of DHI Corp.

Meguon, WI 53092
1-800-558-8700

GENEVA SINGLE HANDLE TUB & SHOWER FAUCET

Models 525709, 525691

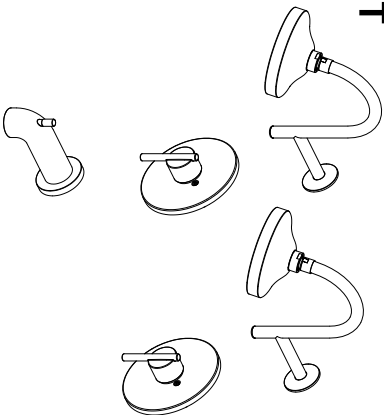

INSTALLATION PROCEDURE

- Preparing for installation
 - Shut off the water supply to the tub and shower.
 - Verify that the hole sizes and positions of the holes in the wall are correct:
 - The shower and tub spout outlet holes should be 1-1/4 in. diameter.
 - The valve access hole dimensions should be 6 in. diameter.
 - The recommended valve depth to the finished wall is 2-1/8 in. min. to 3 in. max.
 - Ensure that the valve body (1) cover is flush with the finished exterior surface of the wall. Position the valve body (1) correctly in the wall with the side marked "UP" pointing up. The 8 in. minimum from the valve body (1) to the tub spout is required for proper operation.
- Removing the plaster guard
 - Unscrew the screws (1), and remove the plaster guard (2).
- Tub & shower outlet connections

Wrap thread sealant tape (not included) around the pipe threads in a clockwise direction, as shown. Connect the hot and cold water supply lines (1, not included), the shower outlet pipe (2, not included), and tub outlet pipe (3, not included) by threading them into the valve body (4) in a clockwise direction. Tighten the pipes to the valve body (4) with a pipe wrench (not included). Connect the pipe elbows (5, not included) to the end of the shower outlet and tub outlet pipes.

NOTE: a. Be sure to position the body (4) correctly in the wall, with the markings "UP" facing upward.
b. The hot water supply lines go into the H inlet, and the cold water supply lines go into the C inlet.
c. Do not use PEX or CPVC between the valve and spout.

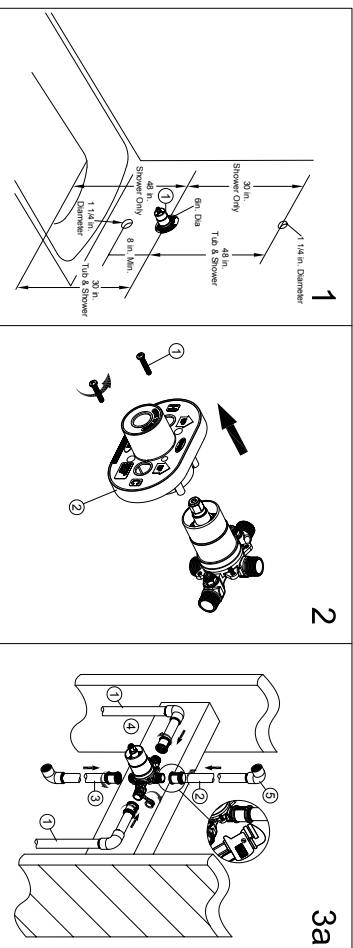

Your new Design House faucet will give you years of trouble free performance. Thank you for choosing our product for your home. **Please read all of these instructions carefully before installing your new faucet.**

Helpful tools to install this faucet:

- basin wrench
- Teflon tape
- (2) crescent wrenches
- silicon sealer
- flashlight
- faucet supply tubes

IMPORTANT POINTS

- When installing your new faucet, hand tighten the connector nuts, then use one wrench to anchor the fitting and a second wrench to tighten the nut one additional turn. Connections that are too tight will reduce the integrity of the system.
- Wrap threaded connections (except aerator thread in spout or where O-ring or rubber sealant are present) with Teflon tape available from your local hardware or plumbing supply store. Always wrap in a clockwise direction.

SAFETY TIPS

- **ALWAYS** protect your eyes with safety glasses.

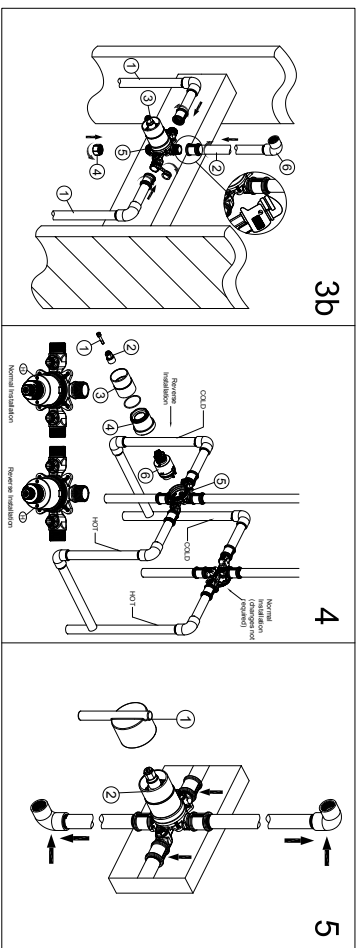

- Shower only outlet connections

Wrap thread sealant tape (not included) around the pipe threads in a clockwise direction. Connect the hot and cold water supply lines (1, not included), the shower outlet pipe (2, not included) into the valve body (3) in a clockwise direction. Tighten the pipes to the valve body (3) with a pipe wrench (not included). Wrap thread sealant tape around the threads of the plug (4), and insert it into the bottom outlet (5). Connect the pipe elbows (6, not included) to the end of the shower outlet pipe.

NOTE: a. Be sure to position the body (3) correctly in the wall, with the markings "UP" facing upward.
b. The hot water supply lines go into the H inlet, and the cold water supply lines go into the C inlet.
- Back to back installation

If the hot and cold inlets are reversed (not on right and cold on left), remove the screw (1), inverter (2), sleeve (3), and bonnet (4) from the valve body (5) with reversed supply connections. Rotate the cartridge (6) 180°, so H appears on the right. Install the cartridge making sure that the key is fully engaged with the slot in the valve body (5). Slide the bonnet (4) over the cartridge (6) and thread them onto the valve body (5). Hand tighten securely. Reassemble the sleeve (3), inverter (2) and screw (1). If you are not making a reverse or back to back installation, skip this step and continue with the step 5.

NOTE: Never install the valve body (5) upside down!
- Flushing the water outlets and checking for leaks

Place the handle (1) on the valve body (2) inverter and turn the handle (1) to the full on position. Turn on the hot and cold water supply lines and allow the water to flow from the outlets for one minute, or until all foreign matter has been flushed out. Check for leaks. Shut off the water at the faucet and supply lines. Remove the handle (1).

INSTALLATION PROCEDURE

6. Installing the plaster guard
Place the plaster guard (1) onto the valve body (2) and secure with the screws (3).
NOTE: Be sure to position the plaster guard (1) correctly onto the valve body (2), with the side marked "SHOWER" facing upward.

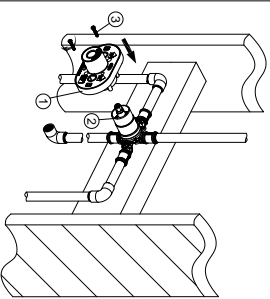

7. Installing the shower arm
Insert the long end of the shower arm (1) through the shower hanger (2), and wrap thread sealant tape (not included) around the long end of the shower arm (1) in a clockwise direction, as shown. Install the long end of the shower arm (1) into the pipe elbow inside the wall. Carefully tighten the shower arm (1) with a clean strap wrench. Do not over tighten. Wrap thread sealant tape around the pipe threads of the tub spout outlet (3, not included) in a clockwise direction, as shown. Connect the tub spout outlet pipe (the tub spout outlet pipe should project 4-1/8" in. to 4-9/32" in. from the finished wall) to the lower pipe elbow (4, not included). Tighten the elbow and tub spout outlet pipe connections with a strap wrench.

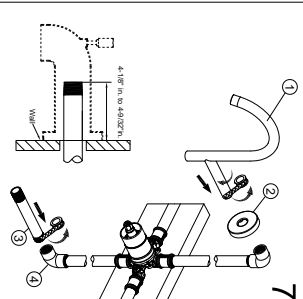

8. Installing the tub spout
Install tub spout. Thread spout onto threaded connection clockwise until the spout becomes flush with the finished wall.
Thread sealant may be required depending on your installation method. All thread sealants may be found at your local hardware store.

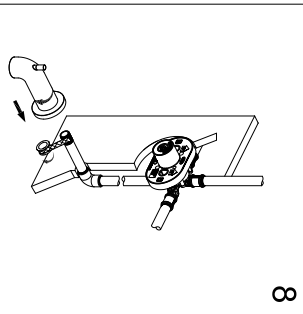

9. Removing the plastic cap
Before installing the escutcheon, remove the plastic cap (1) from the valve body (2) by twisting the cap in a clockwise direction when the depth distance (which is measured from the center of the shower outlet to the finished wall surface) is 1-1/2 in. to 2-1/2 in..

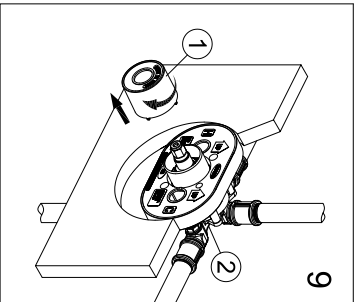

10. Adjusting the sleeve and inverter
A. Removing the sleeve and inverter
Unscrew the sleeve (1) from the valve body (2). Remove the inverter (3) from the valve body (2).

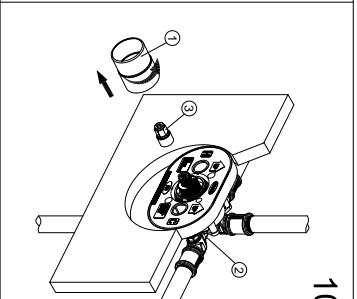

11. Adjusting the temperature
B. Adjusting the desired maximum water temperature
Remove the firm of valve body. Remove the red limit stop ring from the cartridge assembly. For colder water, adjust the temperature limiter in a clockwise direction as shown. For hotter water, adjust the temperature limiter in a counterclockwise direction as shown. Reinstall the firm.
NOTE: A thermometer can be held in the running water to aid in reaching the desired water temperature.

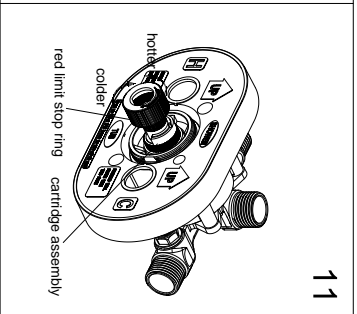

12. Adjusting the temperature
C. Reinstalling the inverter and sleeve
Place the inverter (1) onto the valve body (2) and rotate the inverter (1) with notch facing down. Screw the sleeve (3) onto the valve body (2). Rotate the cartridge stem (4) clockwise to turn off the water before you install the handle.

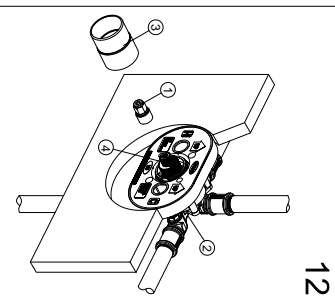

13. Install escutcheon (1) onto valve and then insert screws (3) to attach to valve body. Place handle assembly (4) onto the valve and secure with set screw (5).

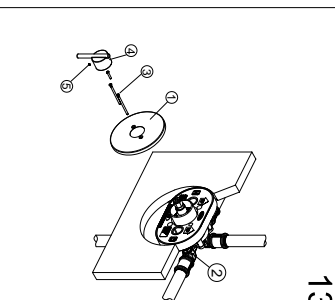

14. Checking for leaks
Turn the handle (1) to the full on mixed position. When the valve body (2) is turned on, water normally flows through the tub spout (3). To activate the shower, turn the valve on and pull the knob (4) up. Hold the knob (4) until the water flows continuously from the shower arm (5). Check for leaks. Shut off the water at the faucet and supply lines.

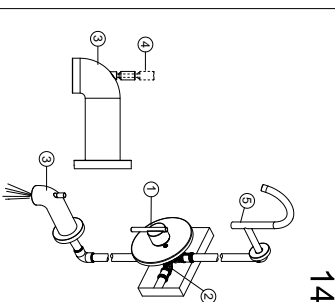

15. Installing the shower head
Attach the shower head (1) to the shower arm (2). Carefully tighten the shower head (1) with a clean strap wrench.

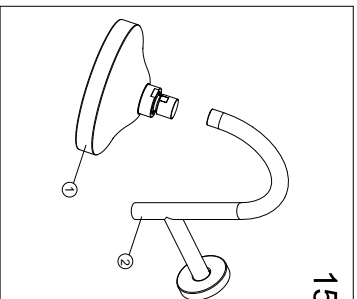

INSTALLATION PROCEDURE

TROUBLE SHOOTING

- o 525709,546721 - Polished Chrome
- o 525691,546739 - Satin Nickel

Problem:
Leaks underneath handle.

Cause:
Bonnet has come loose or cartridge is dirty or broken.

Action:

Remove the handle. Tighten the bonnet.
If water still does not completely shut off, turn off the water supply or turn off the stop valves. Replace the cartridge.

Many of these parts come preassembled. This exploded diagram is to assist in trouble shooting.

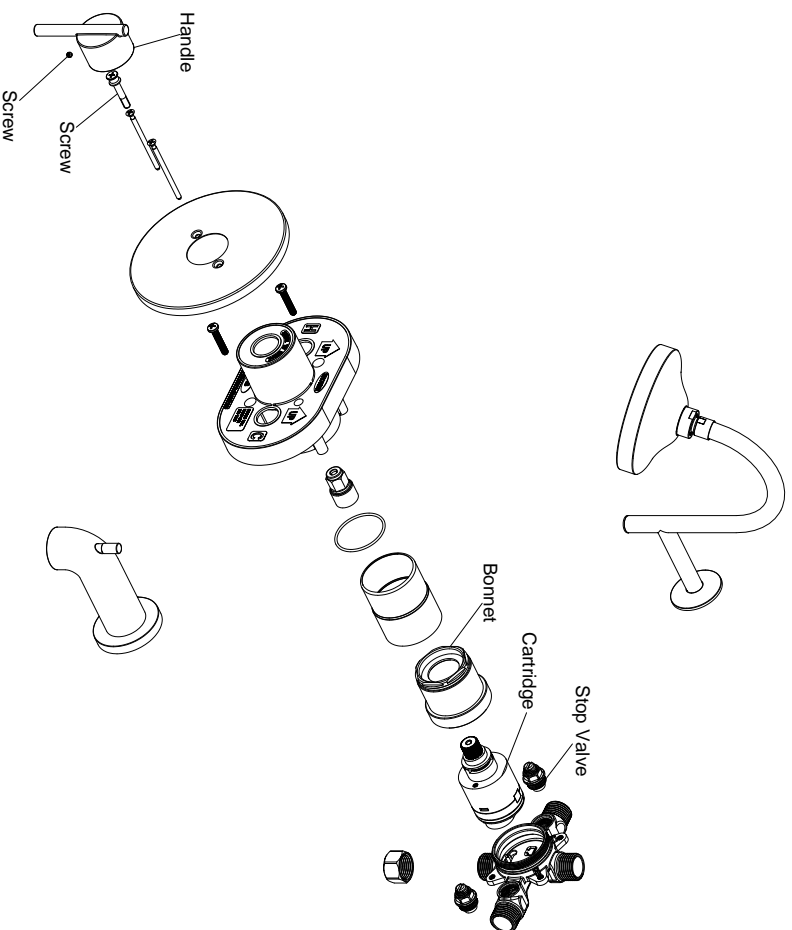

MAINTENANCE

Your new Design House faucet is designed to give you years of trouble free performance. Avoid abrasive cleaners, steel wool and harsh chemicals that will dull the finish and void your warranty.

Brass finishes are polished, then protected with a PVD or a lacquer coating to help prevent tarnishing. Clean these surfaces only with a damp, soft cloth.

Keep it looking like new by cleaning it periodically with a mild solution of soapy water. Rinse thoroughly and then dry with a soft cloth.

CONSUMER PROTECTION WARNING

Under the Safe Drinking Water Act, the U.S. Environmental Protection Agency restricts the amount of lead used in brass and solder. Your new faucet is made in strict compliance with all government standards. The materials used in the manufacture of this faucet are of industry standard quality and are similar to other plumbing products having brass fittings.

To reduce the amount of lead in your drinking water, allow the water to run for a moment before filling your glass and remember to always use cold water for drinking purposes.