

585422

# ASSEMBLY INSTRUCTIONS

# PARTS LIST:

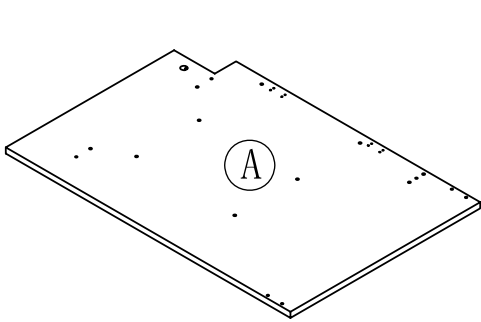

LEFT SIDE PANEL 1PC

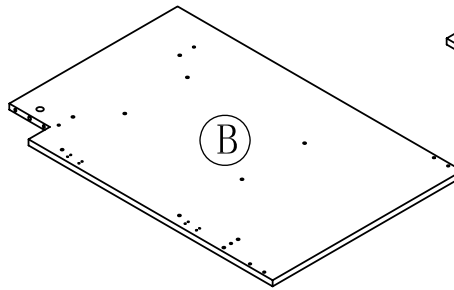

RIGHT SIDE PANEL 1PC

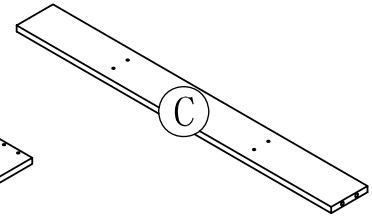

BACK CROSS BRACE 1PC

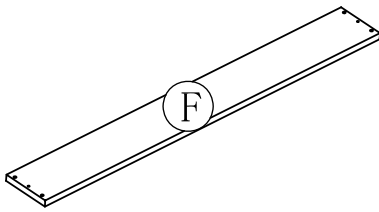

TOE KICK PANEL 1PC

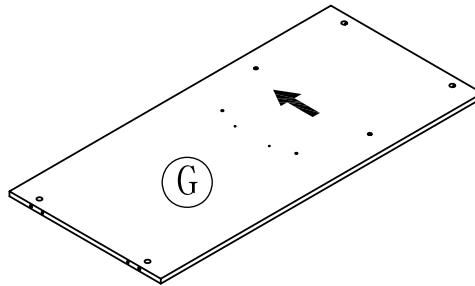

BOTTOM PANEL 1PC

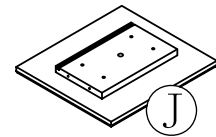

DRAWER FRONT PANEL 2PCS

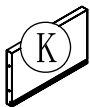

DRAWER BACK PANEL  
2PCS

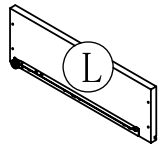

DRAWER LEFT SIDE  
PANEL 2PCS

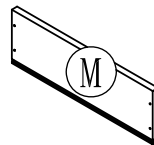

DRAWER RIGHT SIDE  
PANEL 2PCS

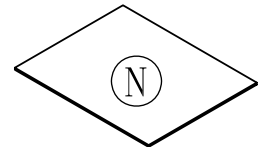

DRAWER BOTTOM  
PANEL 2PCS

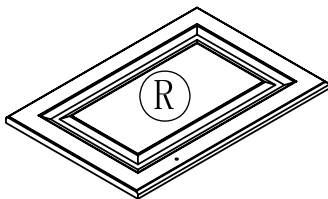

RIGHT SIDE DOOR 1PC

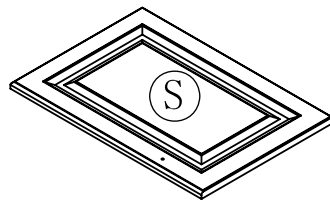

LEFT SIDE DOOR 1PC

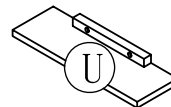

FIXED PANEL 1PC

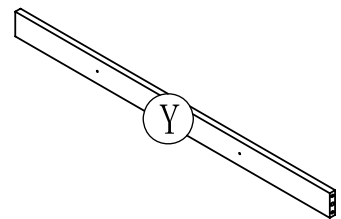

FRONT CROSS BRACE 1PC

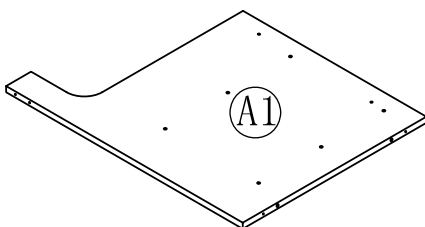

BIG PARTITION 1PC

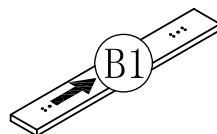

SMALL PARTITION 1PC

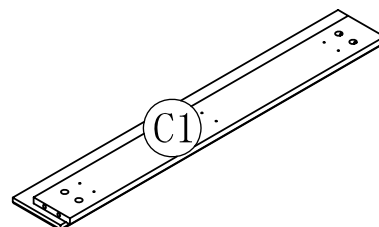

FALSE DRAWER FRONT 1PC

# HARDWARE LIST:



a. WOOD DOWEL 16PCS



b. CAM LOCK SCREW  
16PCS



c. CAM LOCK 16PCS



d. 1" L WOOD SCREW 6PCS



e. 1-1/2" L WOOD  
SCREW 19PCS

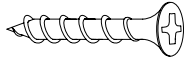

f. 5/8" L FLAT HEAD  
SCREW 24PCS



g. 1/2" L WOOD  
SCREW 12PCS

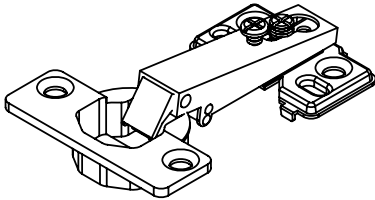

h. HINGE 4PCS

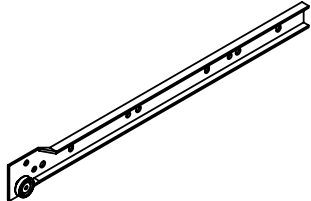

i. LEFT SIDE DRAWER  
GLIDE 2PCS

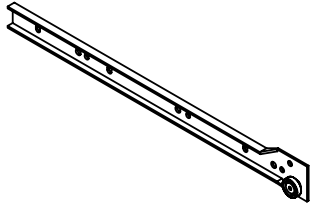

j. RIGHT SIDE DRAWER  
GLIDE 2PCS

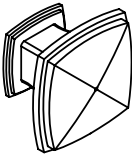

l. KNOB 4PCS

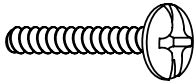

n. KNOB BOLT 4PCS



o. WRENCH 1PC

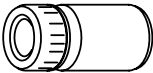

p. GLUE 1PC

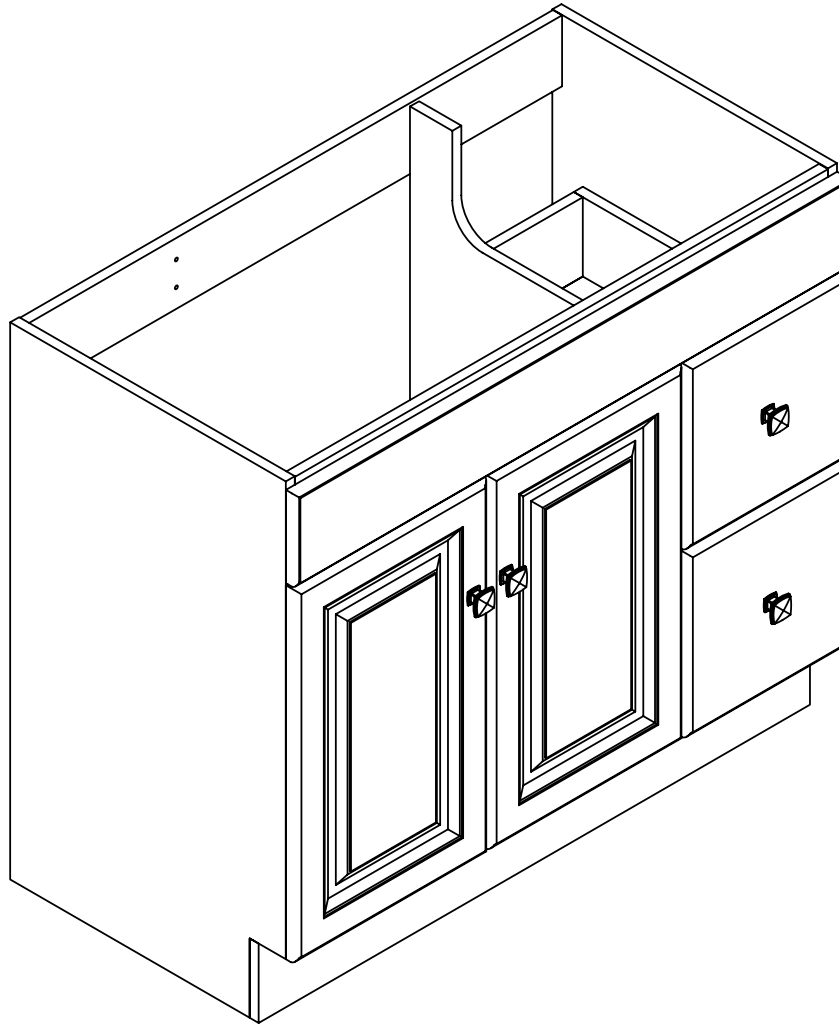

FOLLOW STEPS 1~10 TO INSTALL THE DOORS  
ON THE LEFT SIDE AND THE DRAWERS ON THE  
RIGHT SIDE

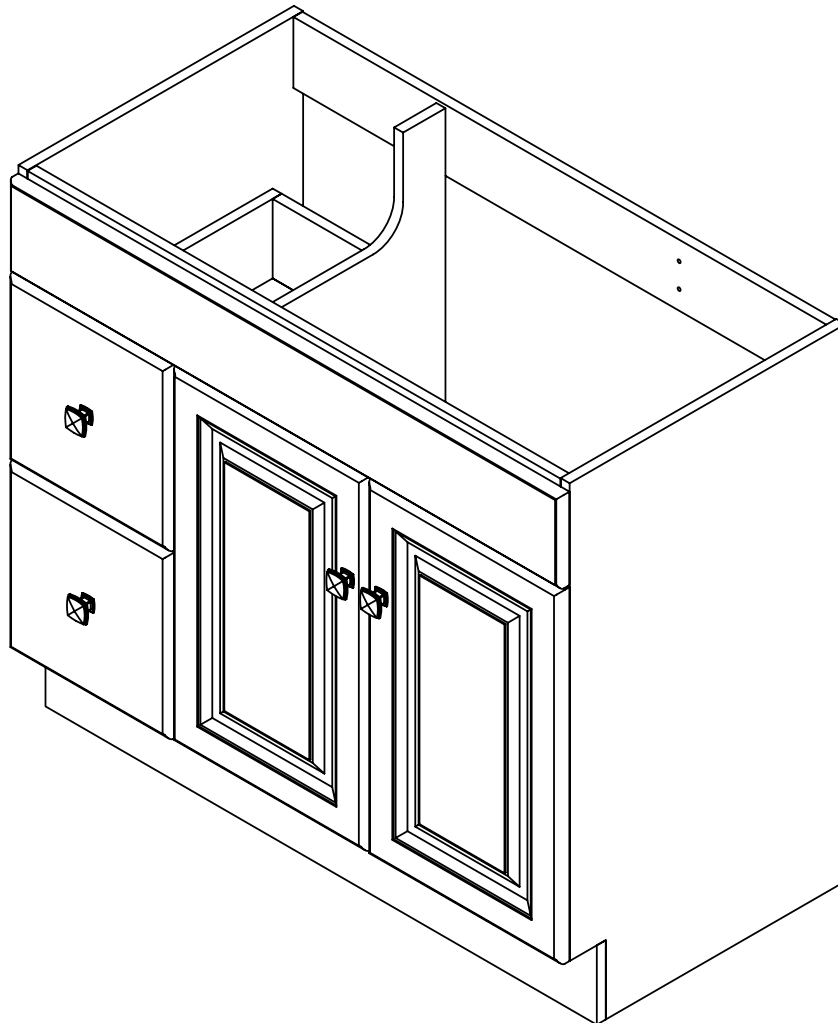

FOLLOW STEPS 11~20 TO INSTALL THE DOORS  
ON THE RIGHT SIDE AND THE DRAWERS ON THE  
LEFT SIDE

# STEP 1

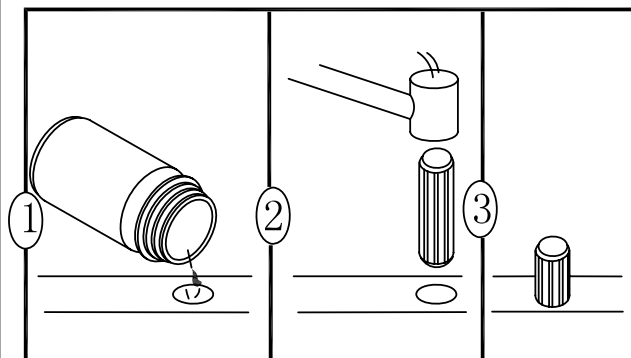
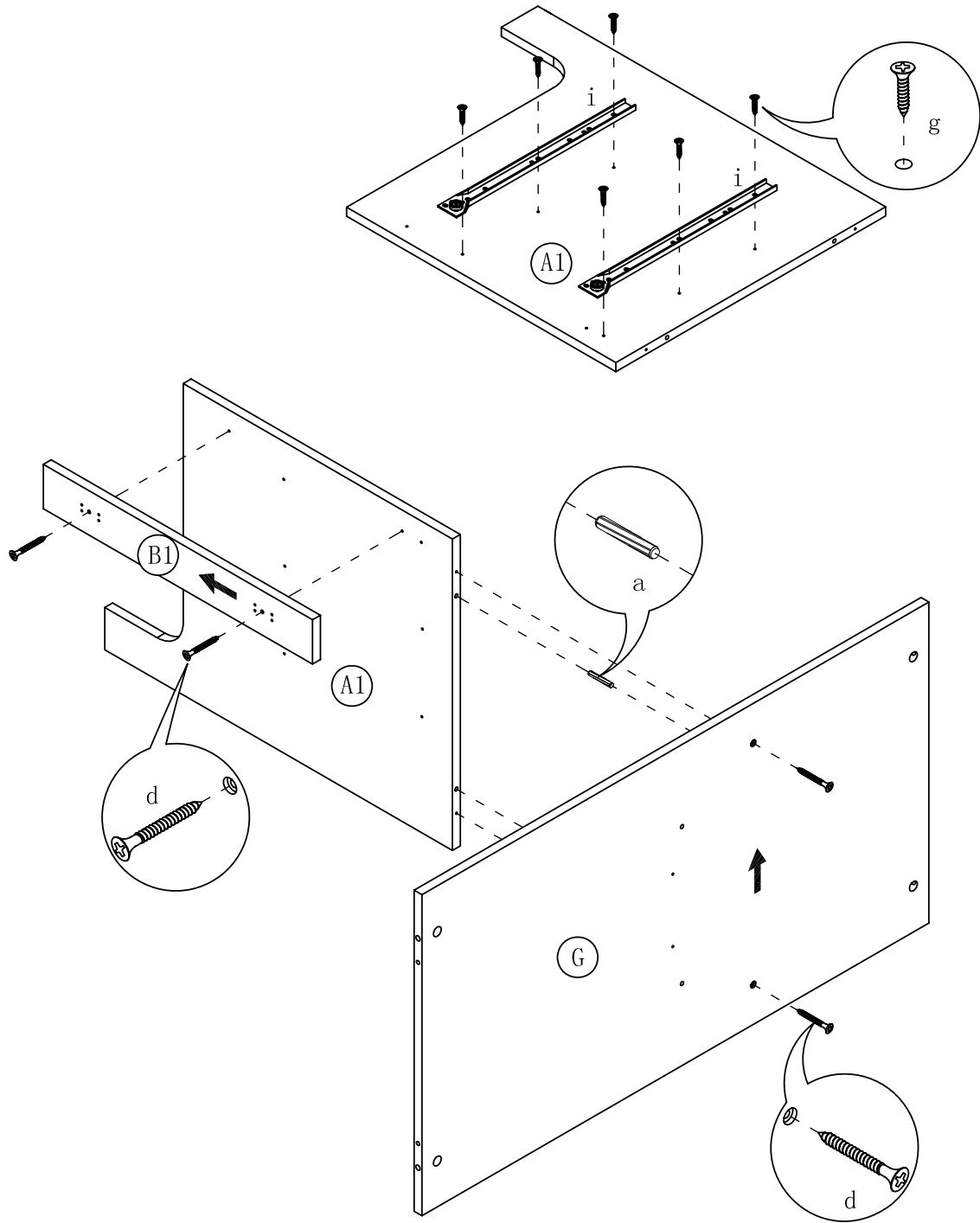

# STEP 2

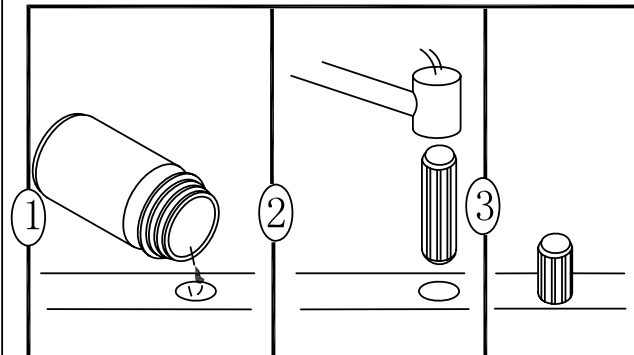
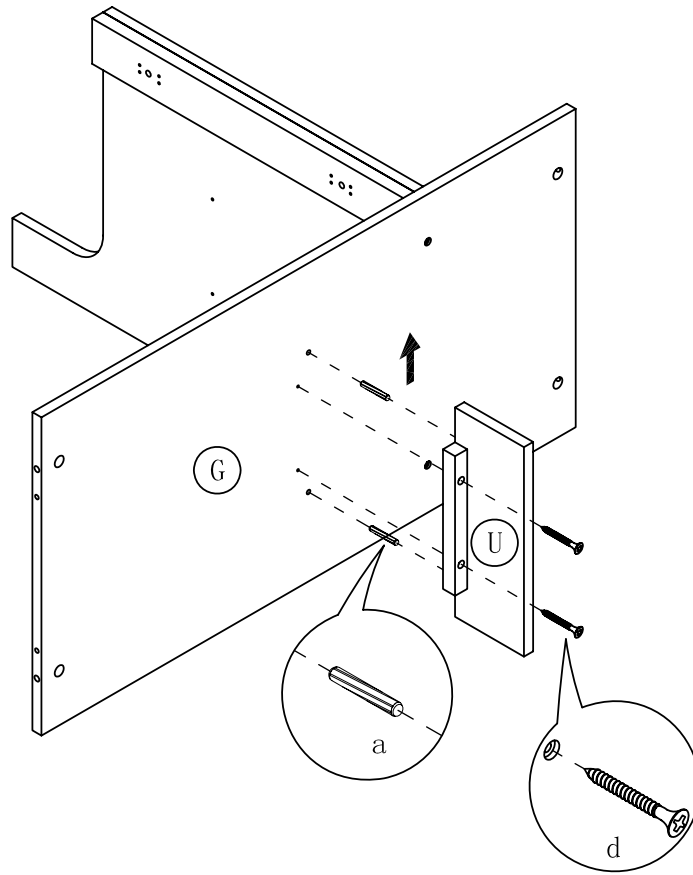

# STEP 3

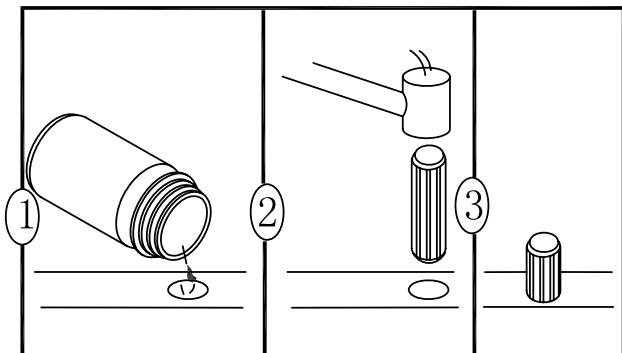
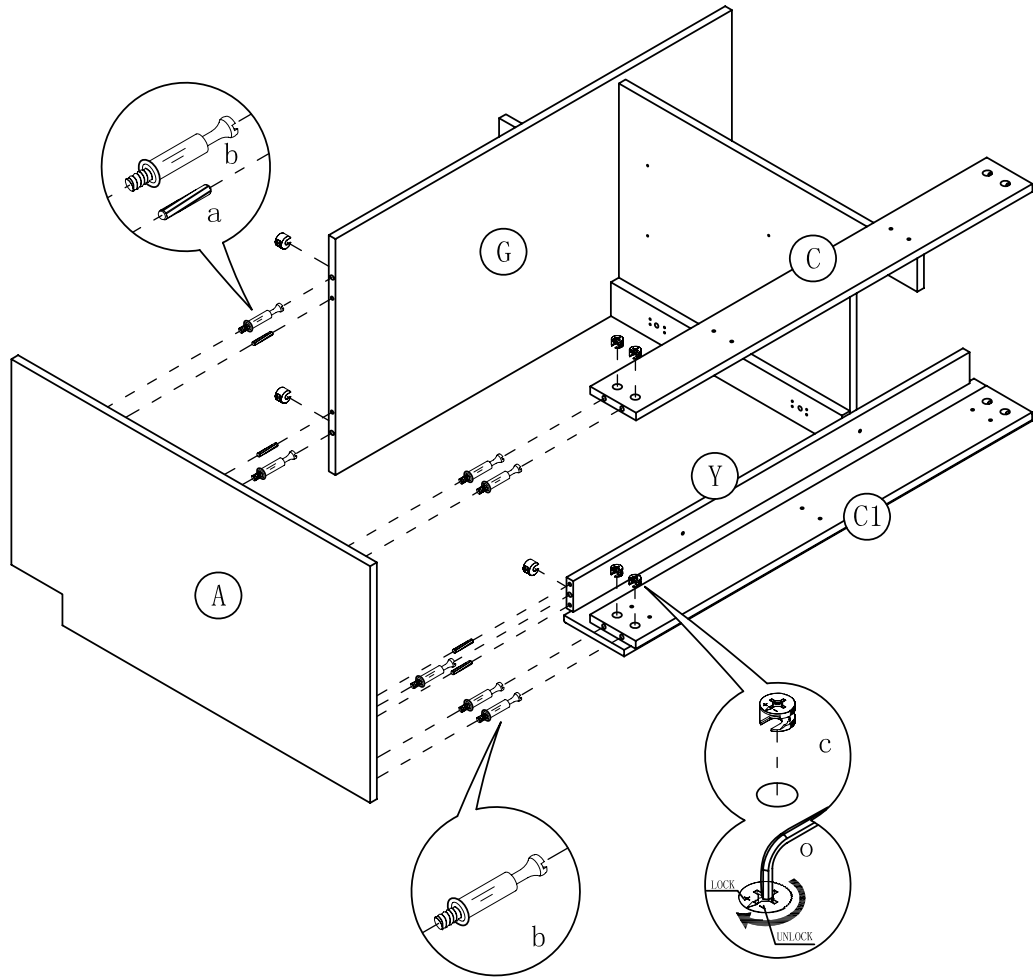



# STEP 4

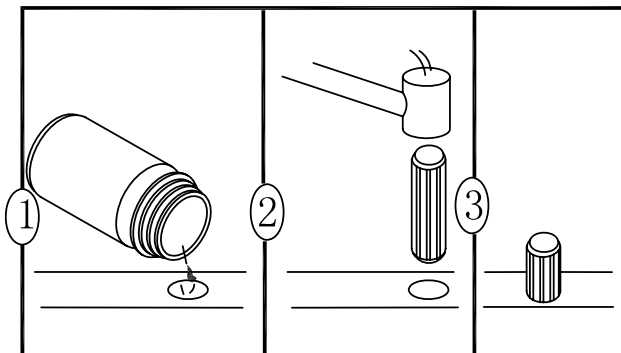
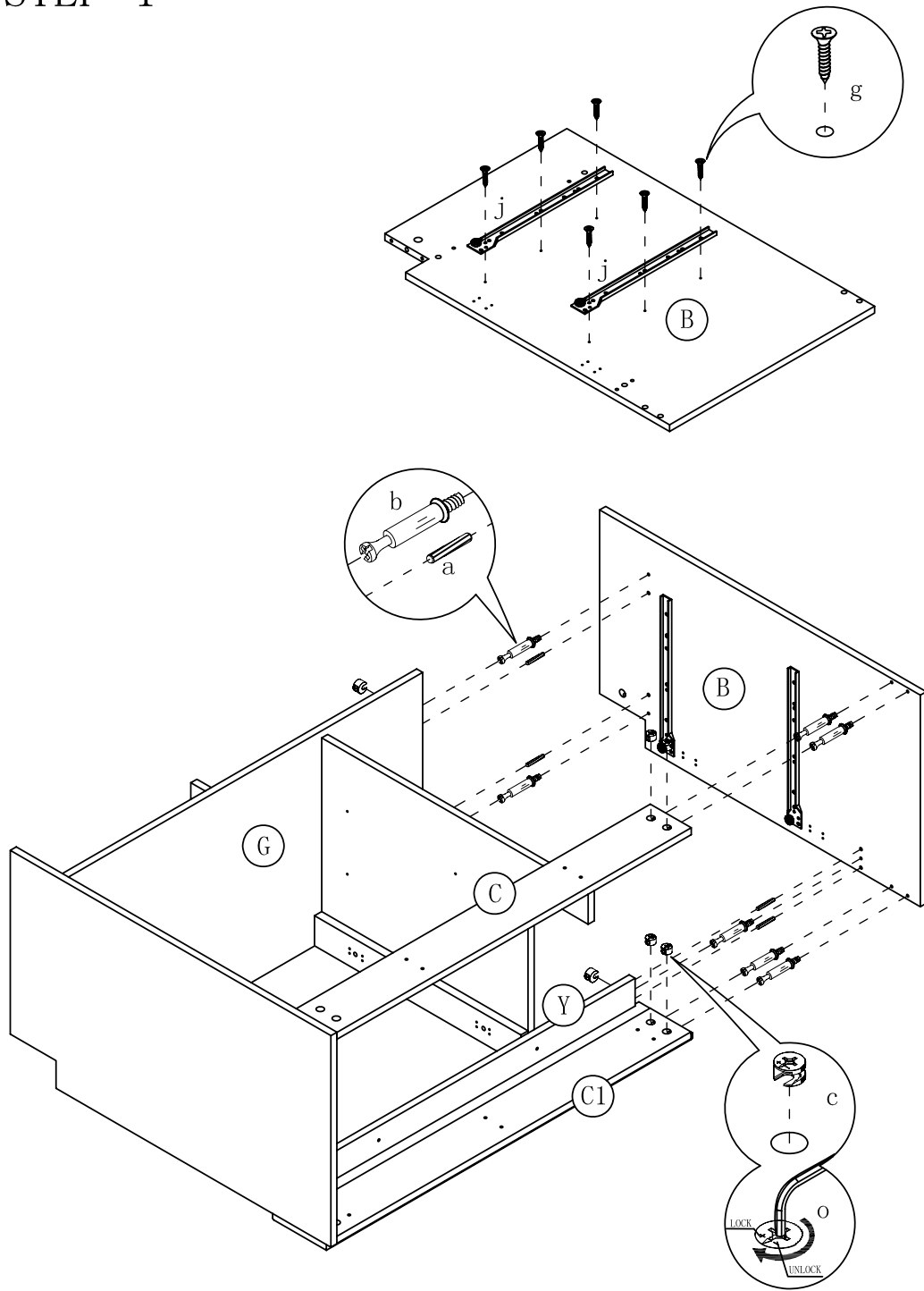

# STEP 5

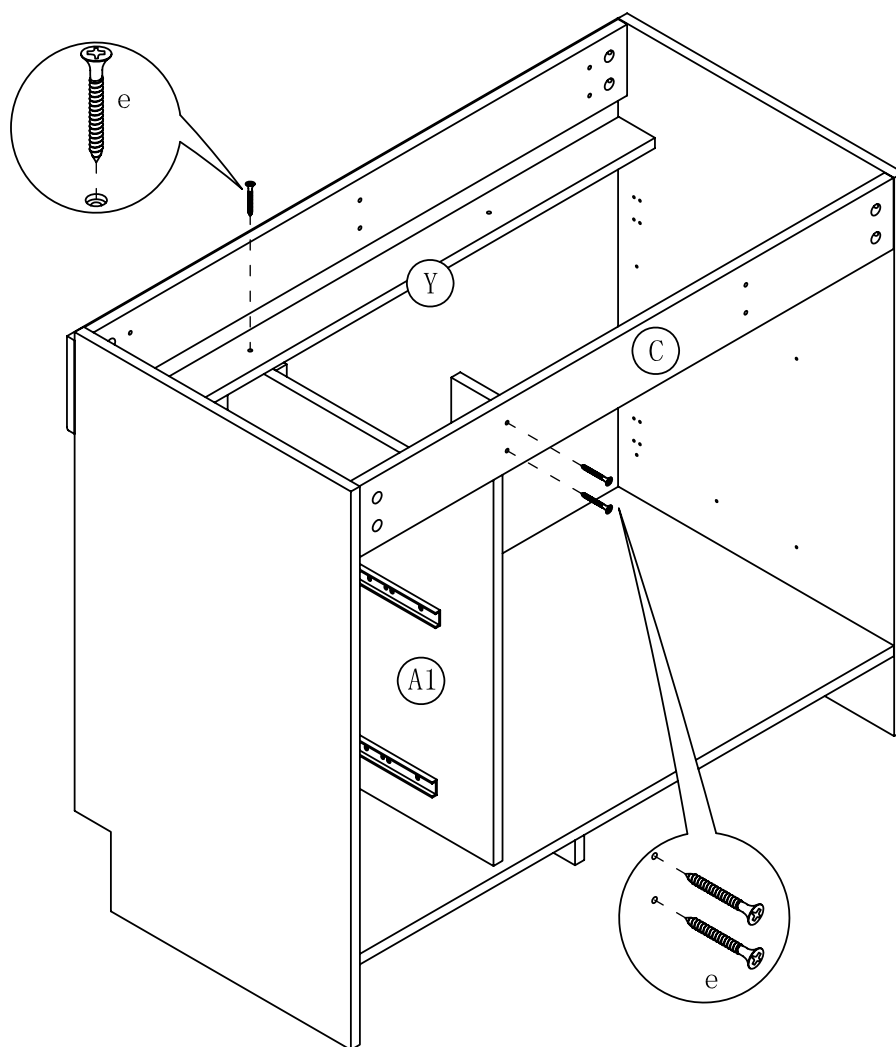

# STEP 6

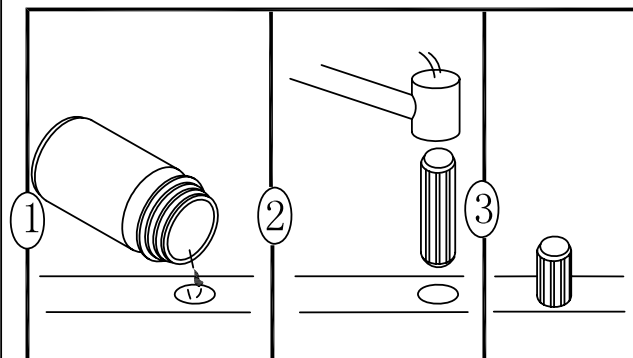
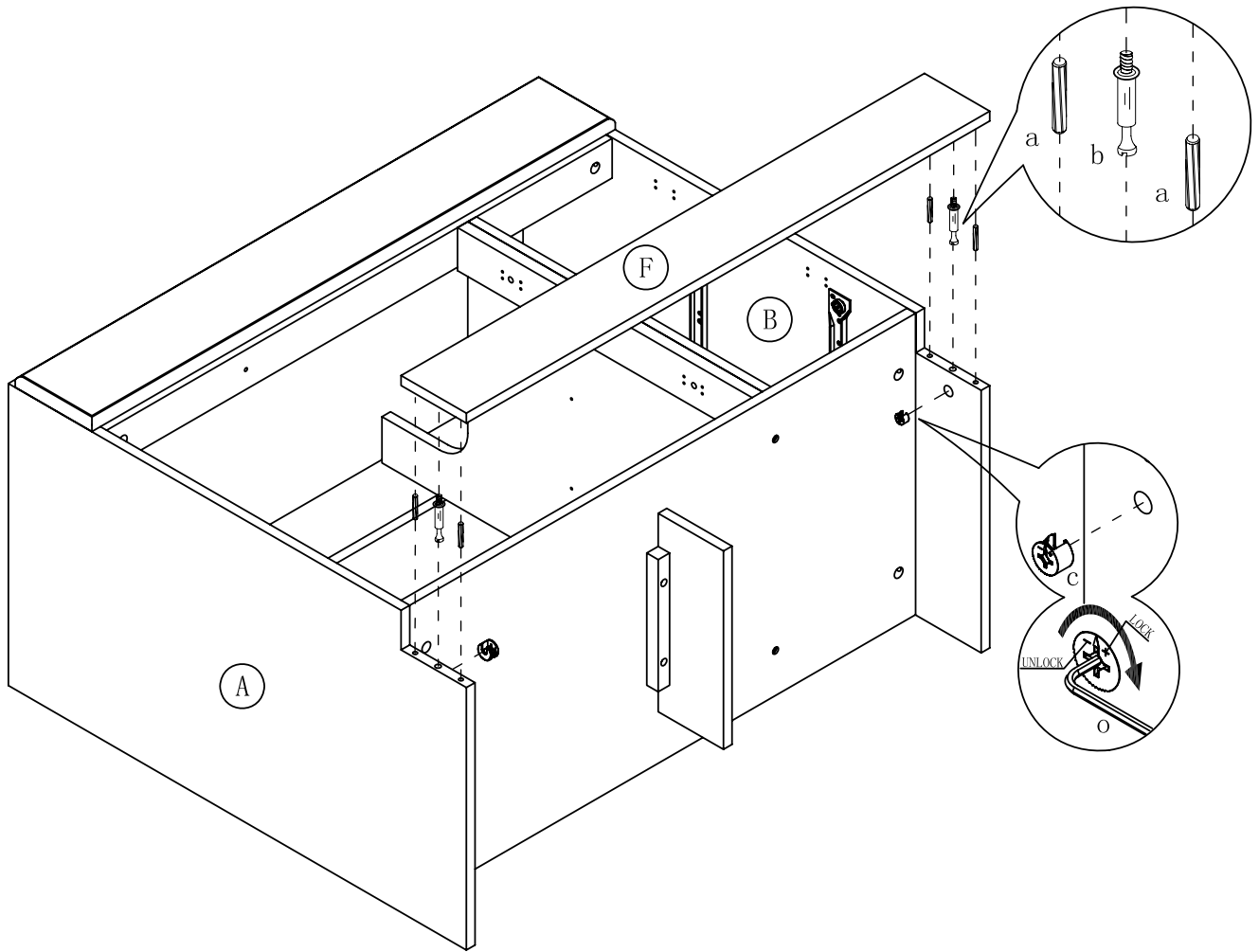

# STEP 7

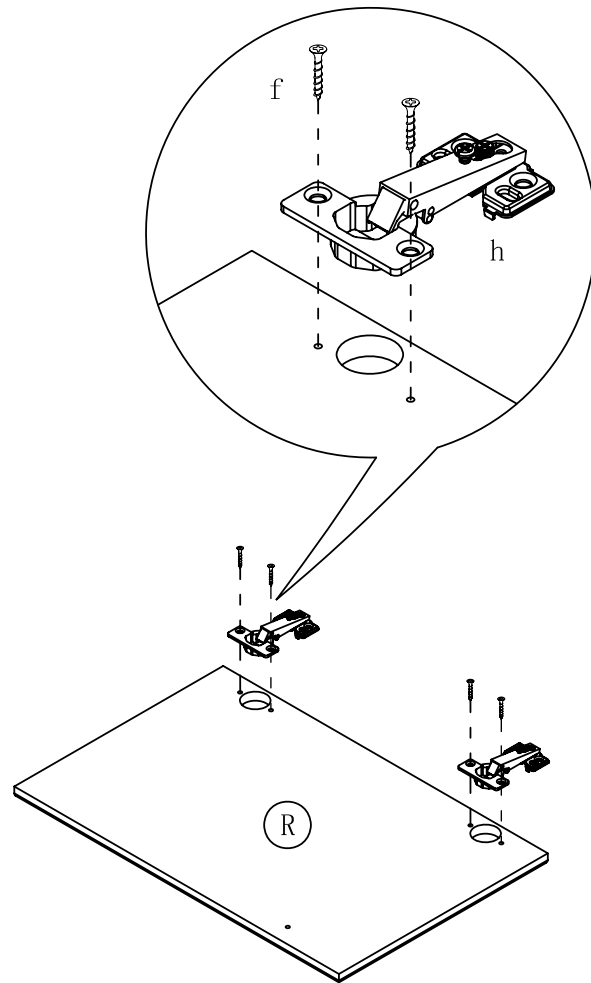
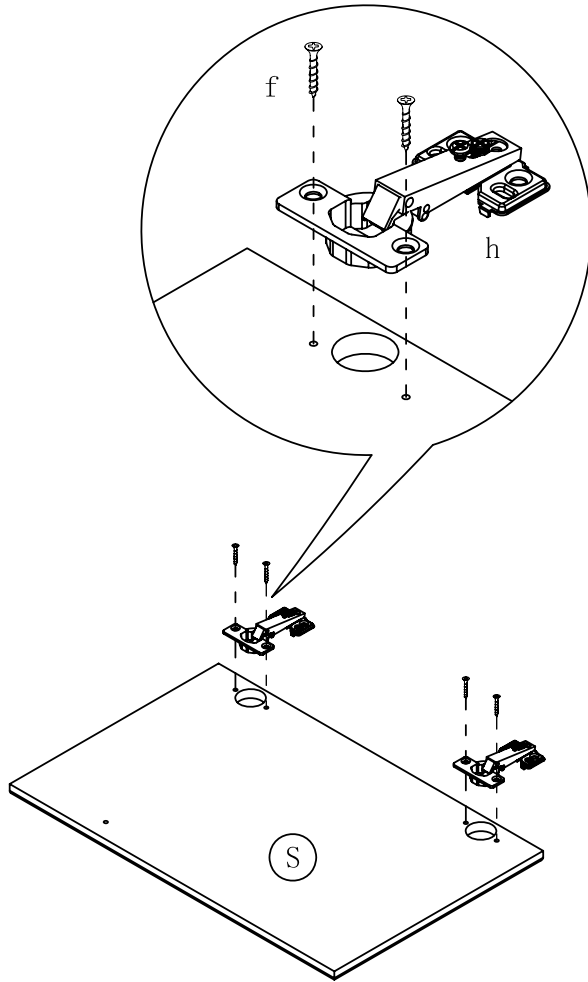

# STEP 8

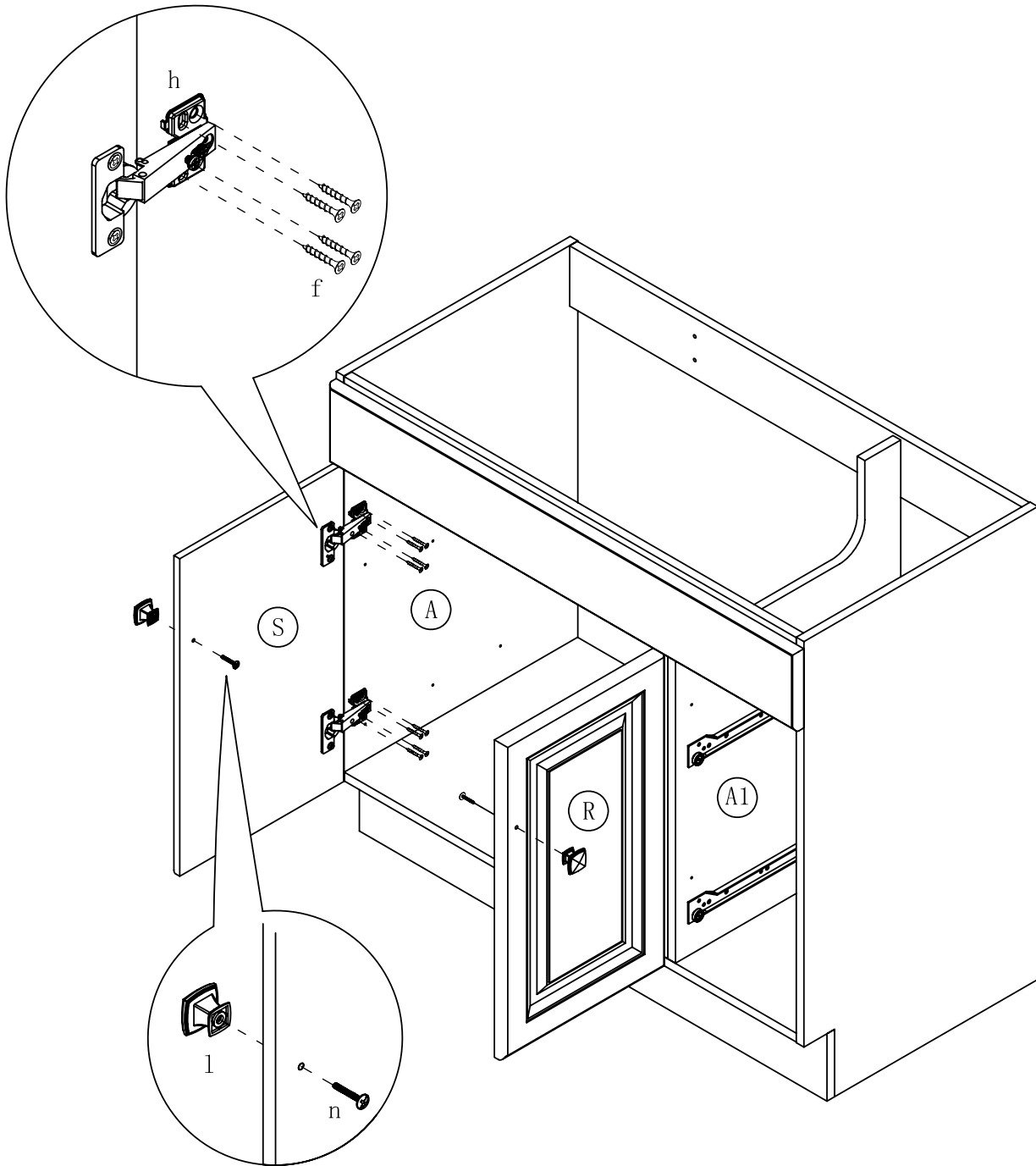

STEP 9

x 2

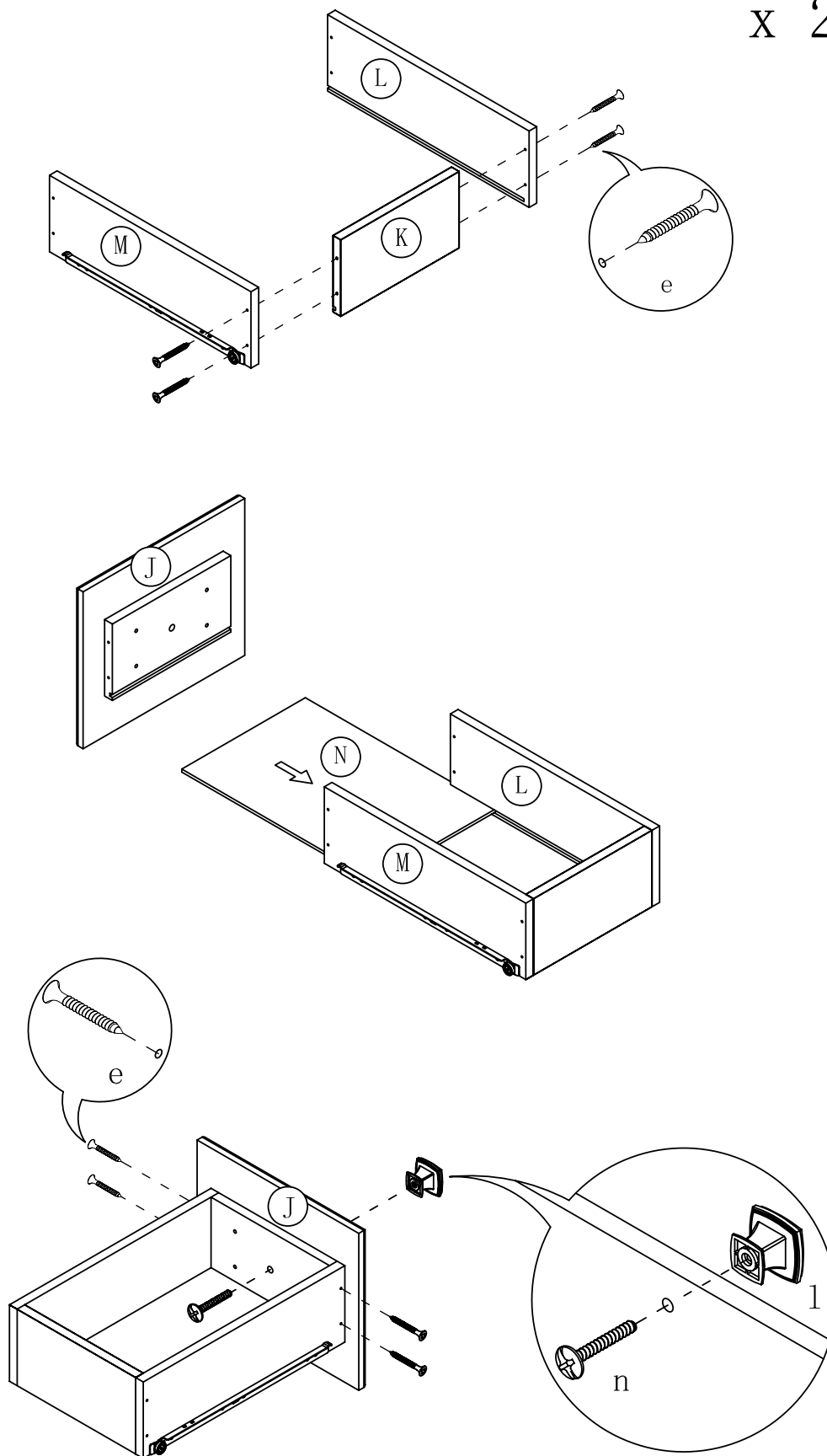

STEP 10

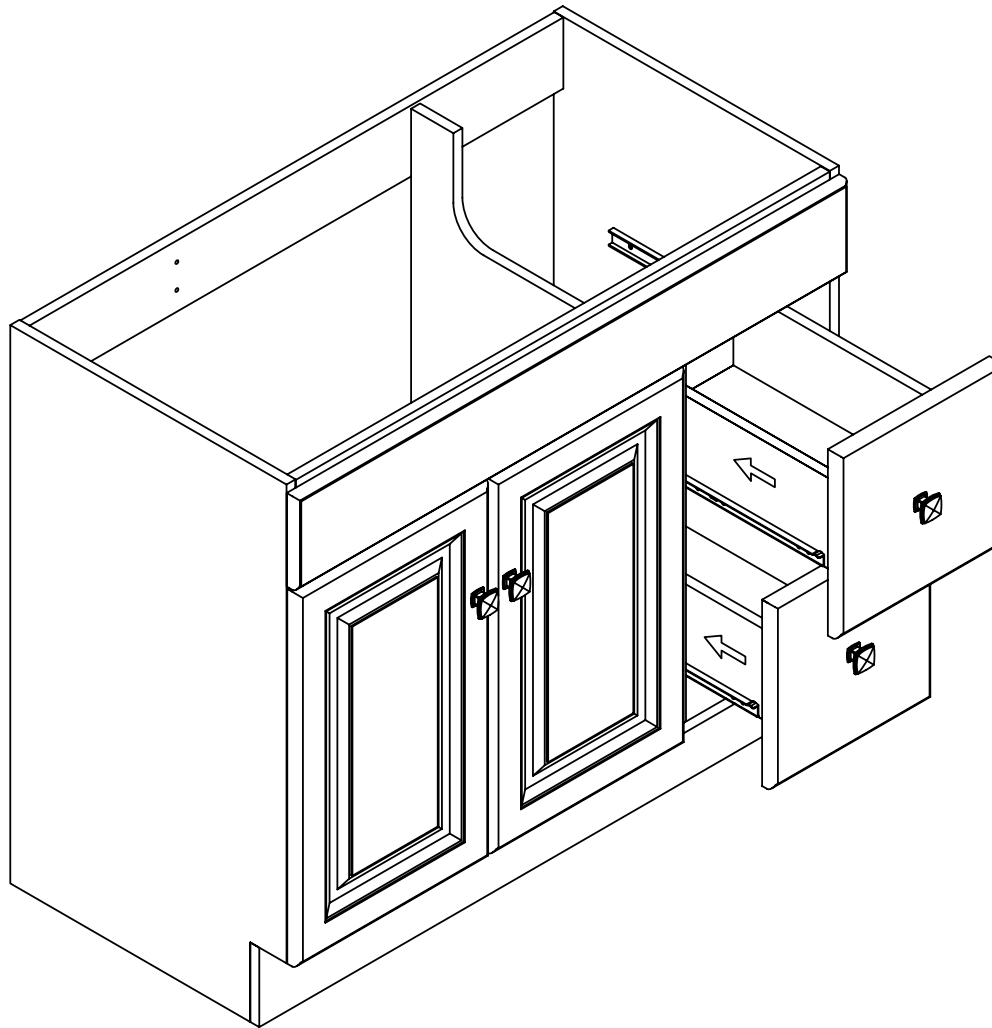

# STEP 11

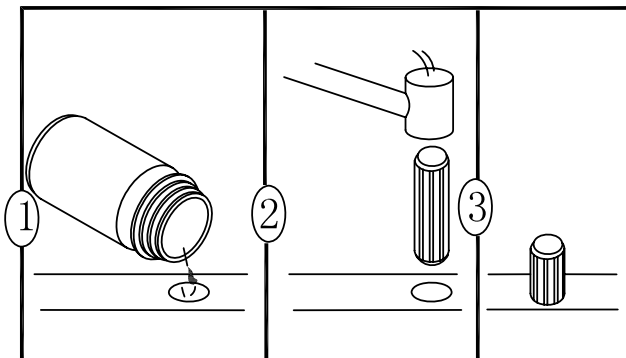
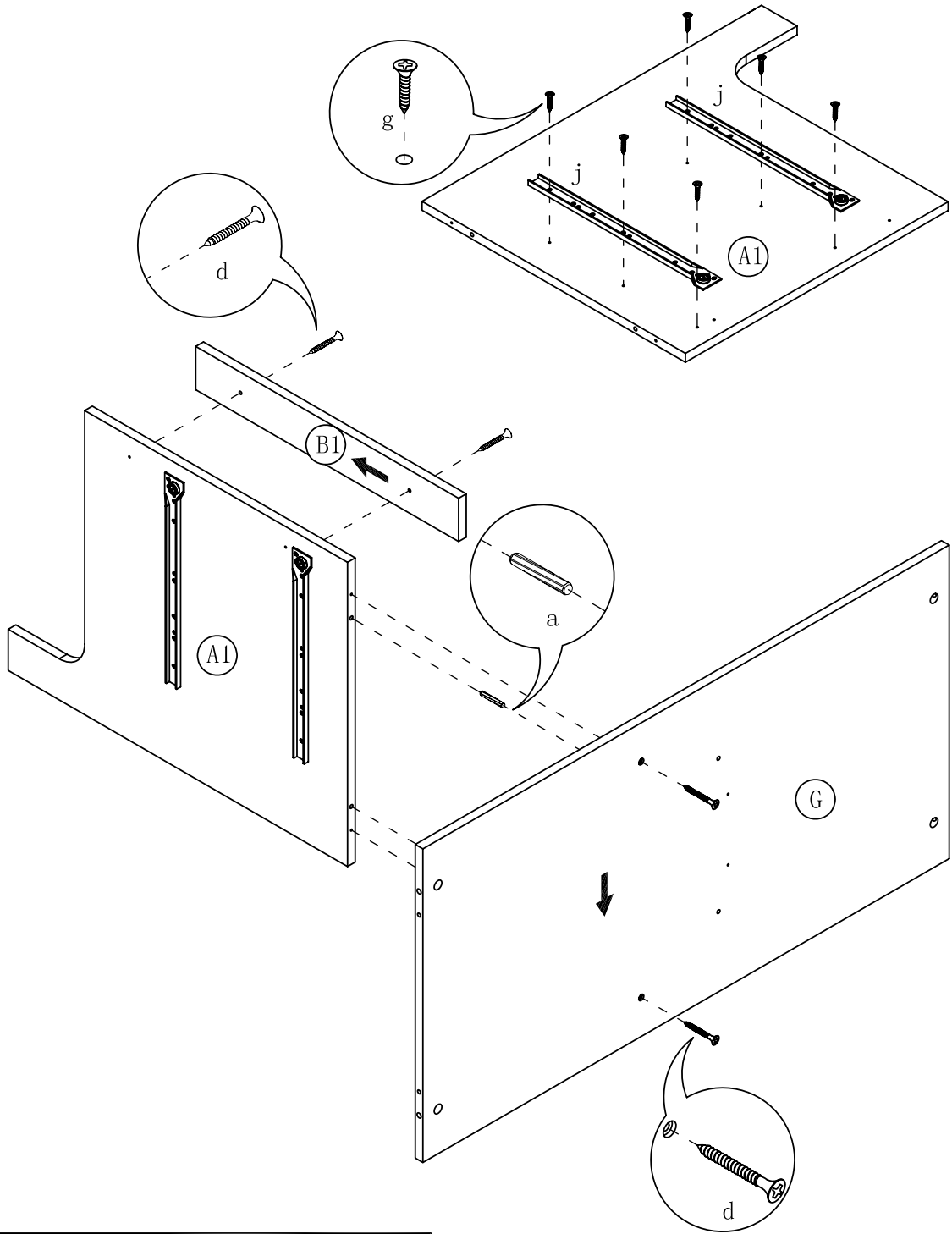



# STEP 12

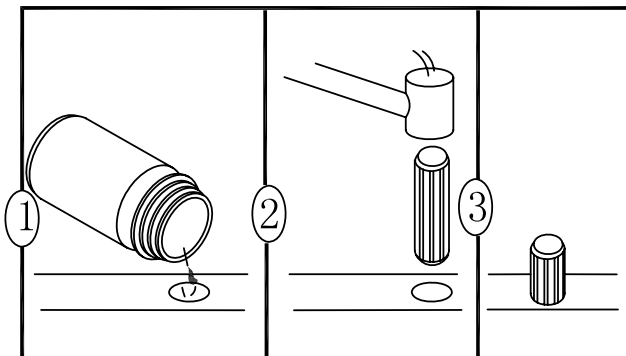
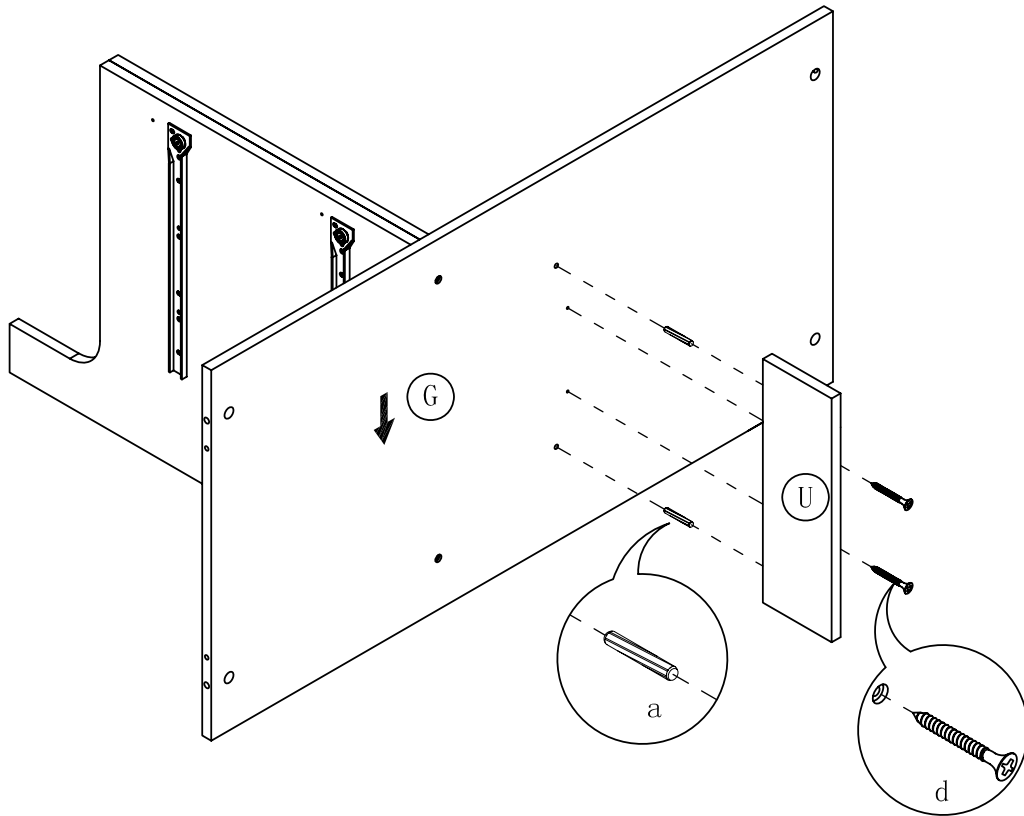

# STEP 13

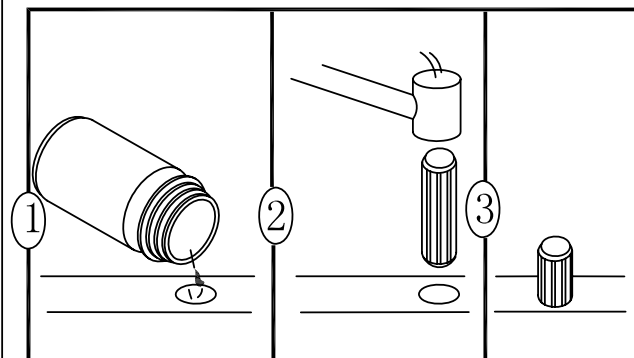
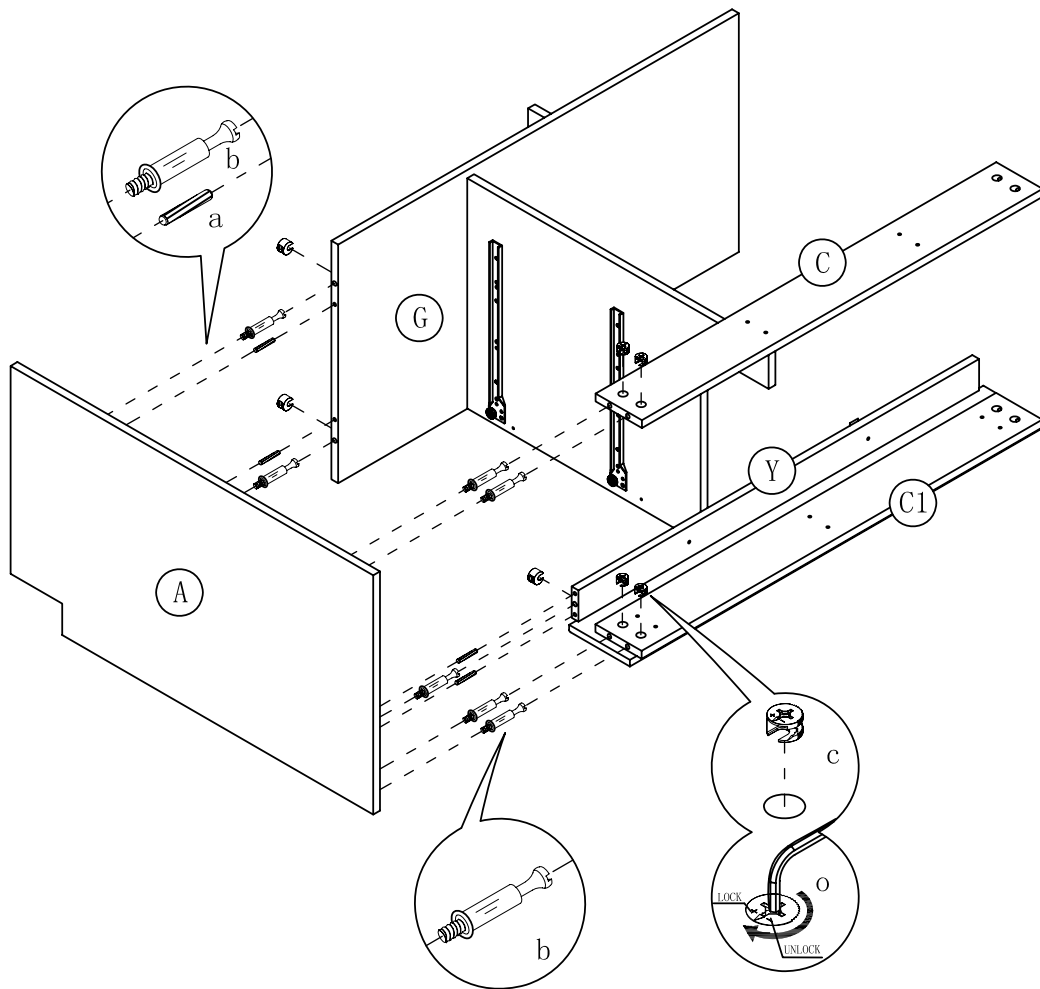
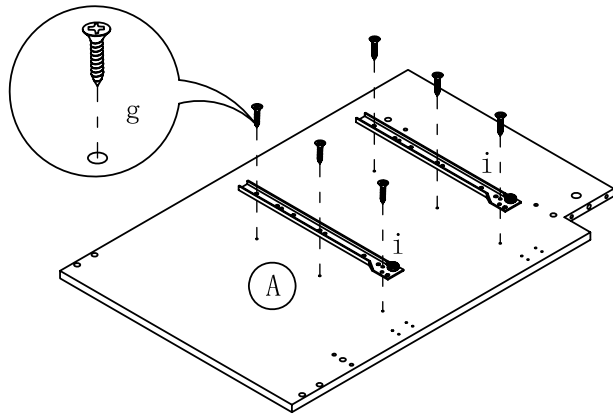

# STEP 14

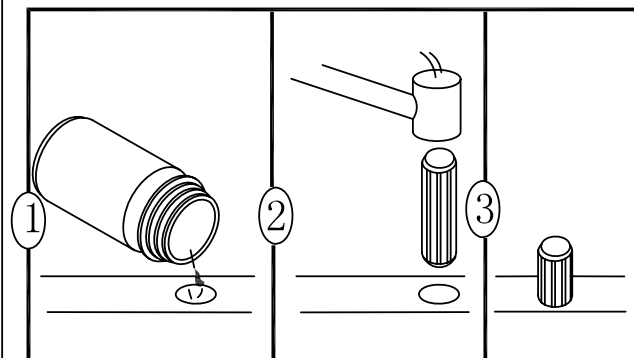
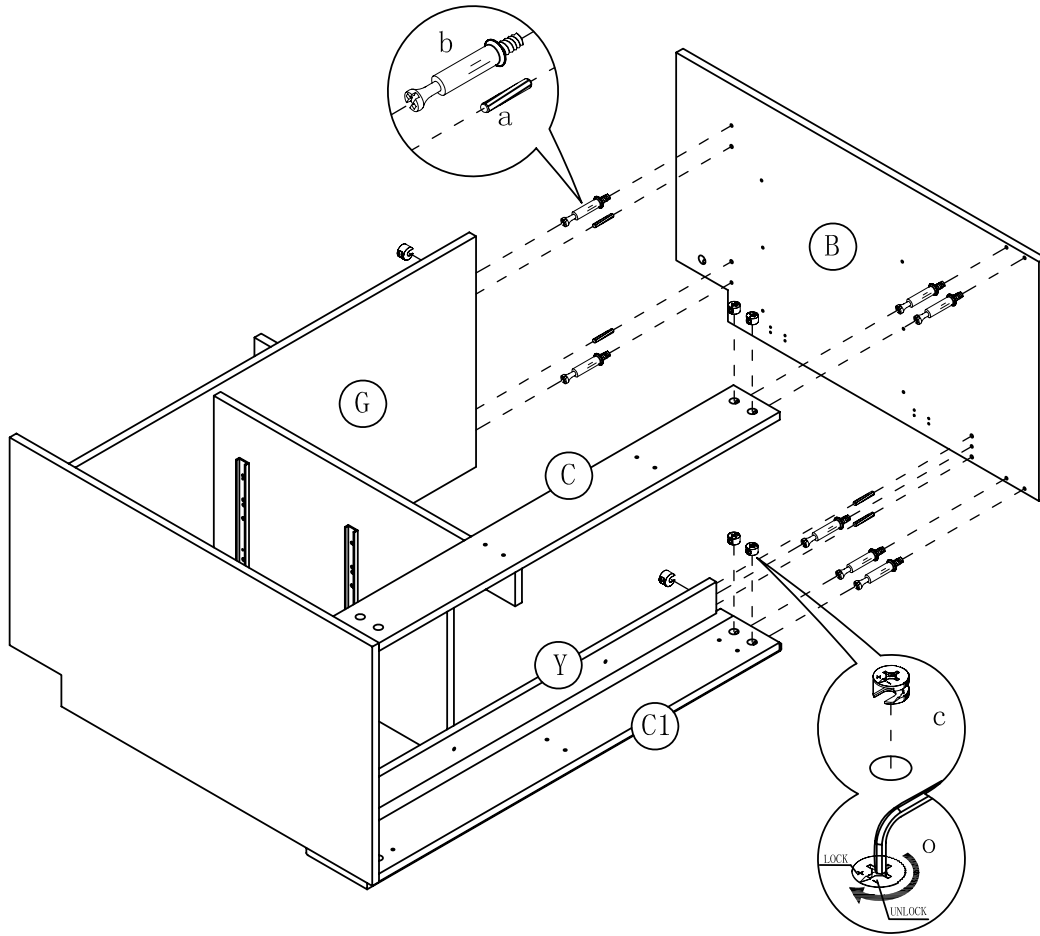

STEP 15

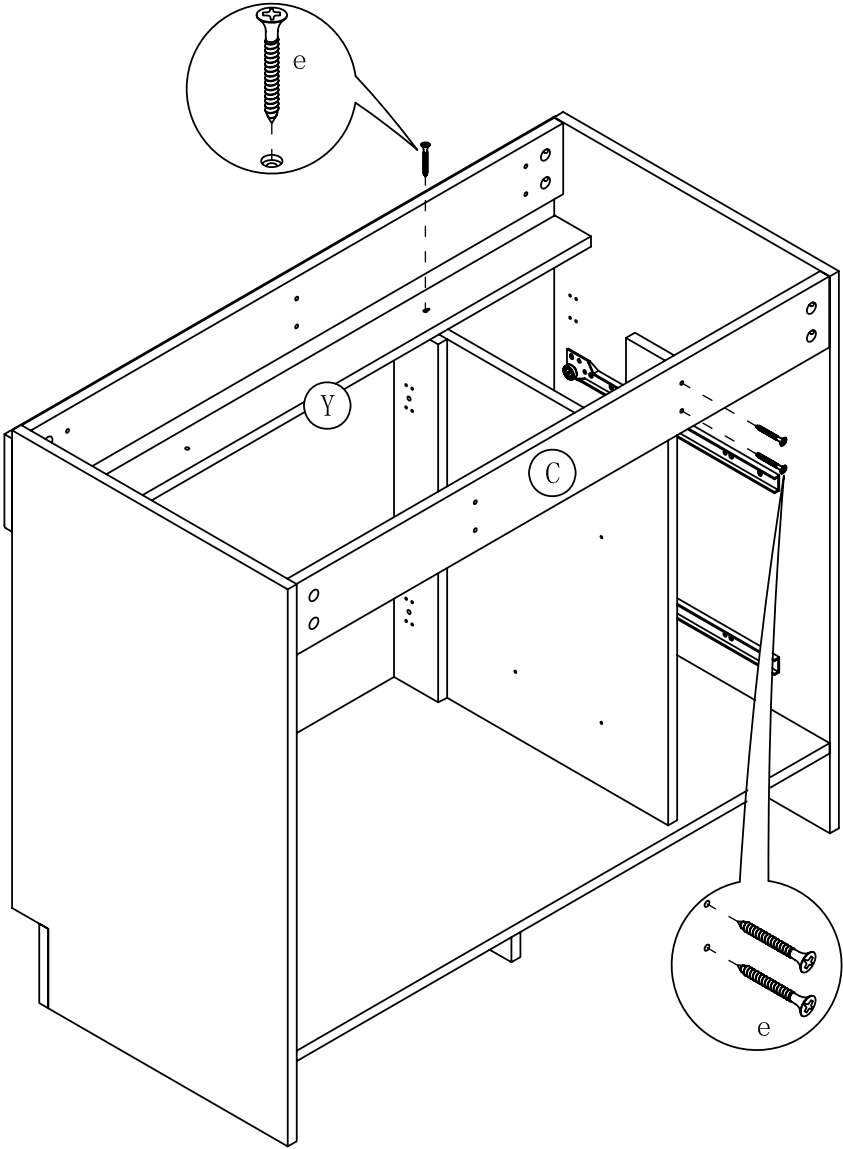

STEP 16

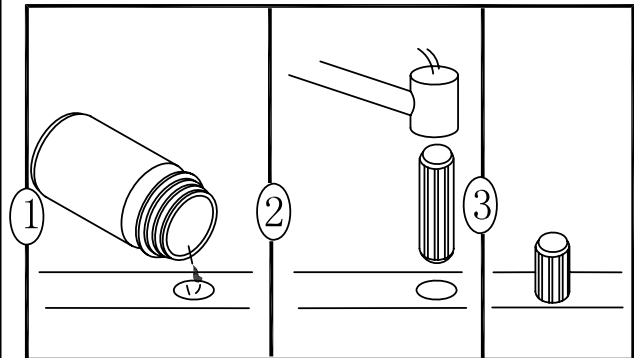
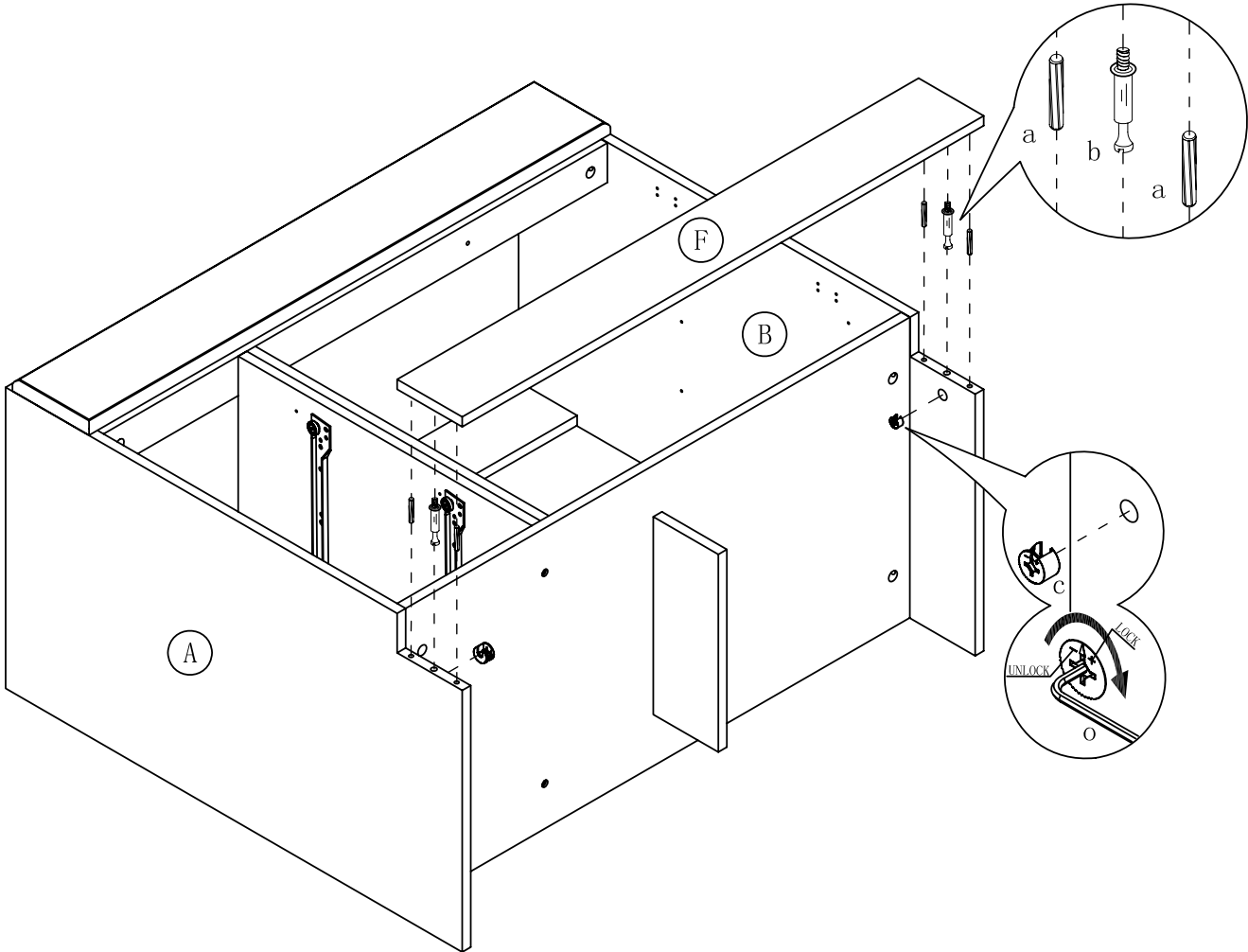

# STEP 17

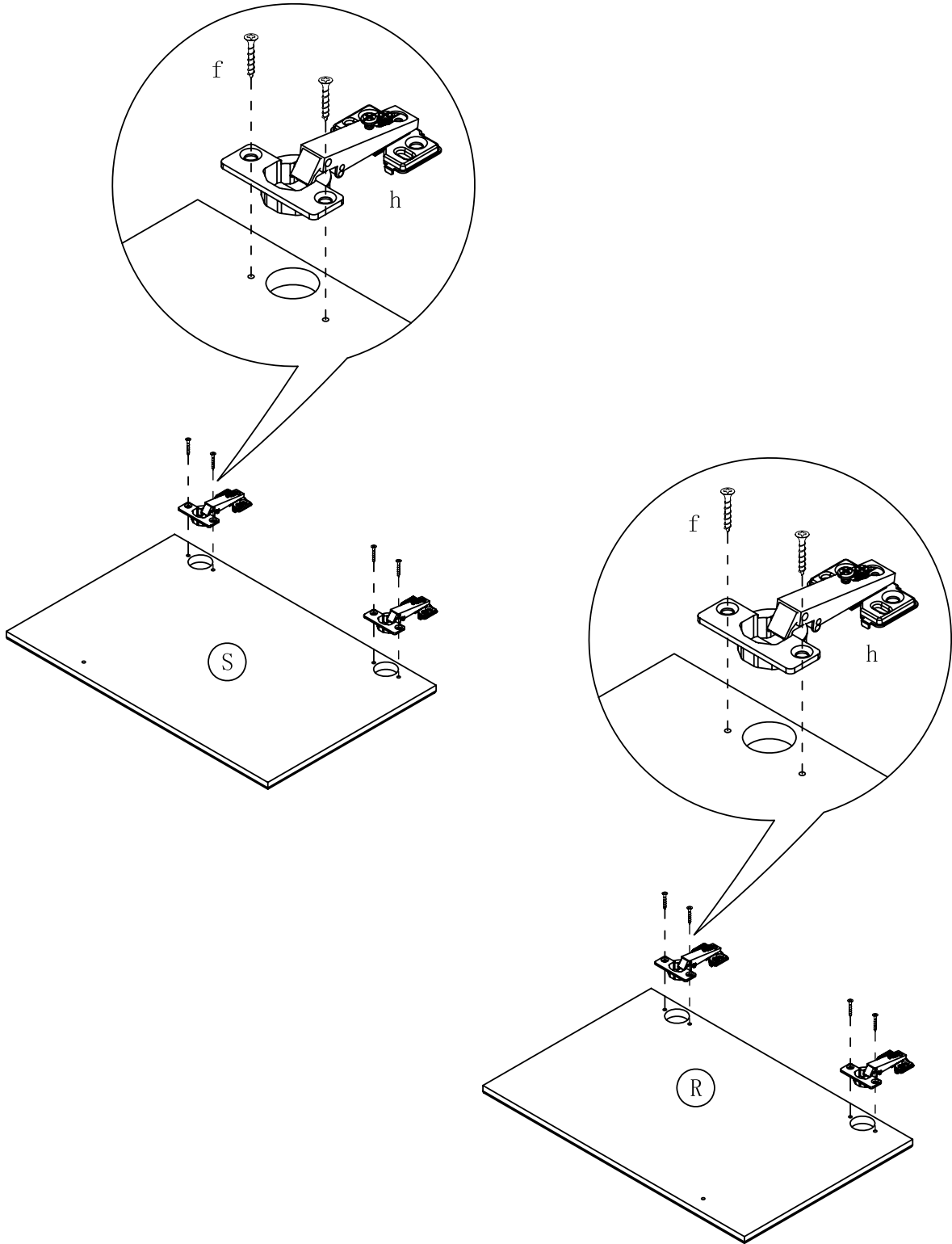

# STEP 18

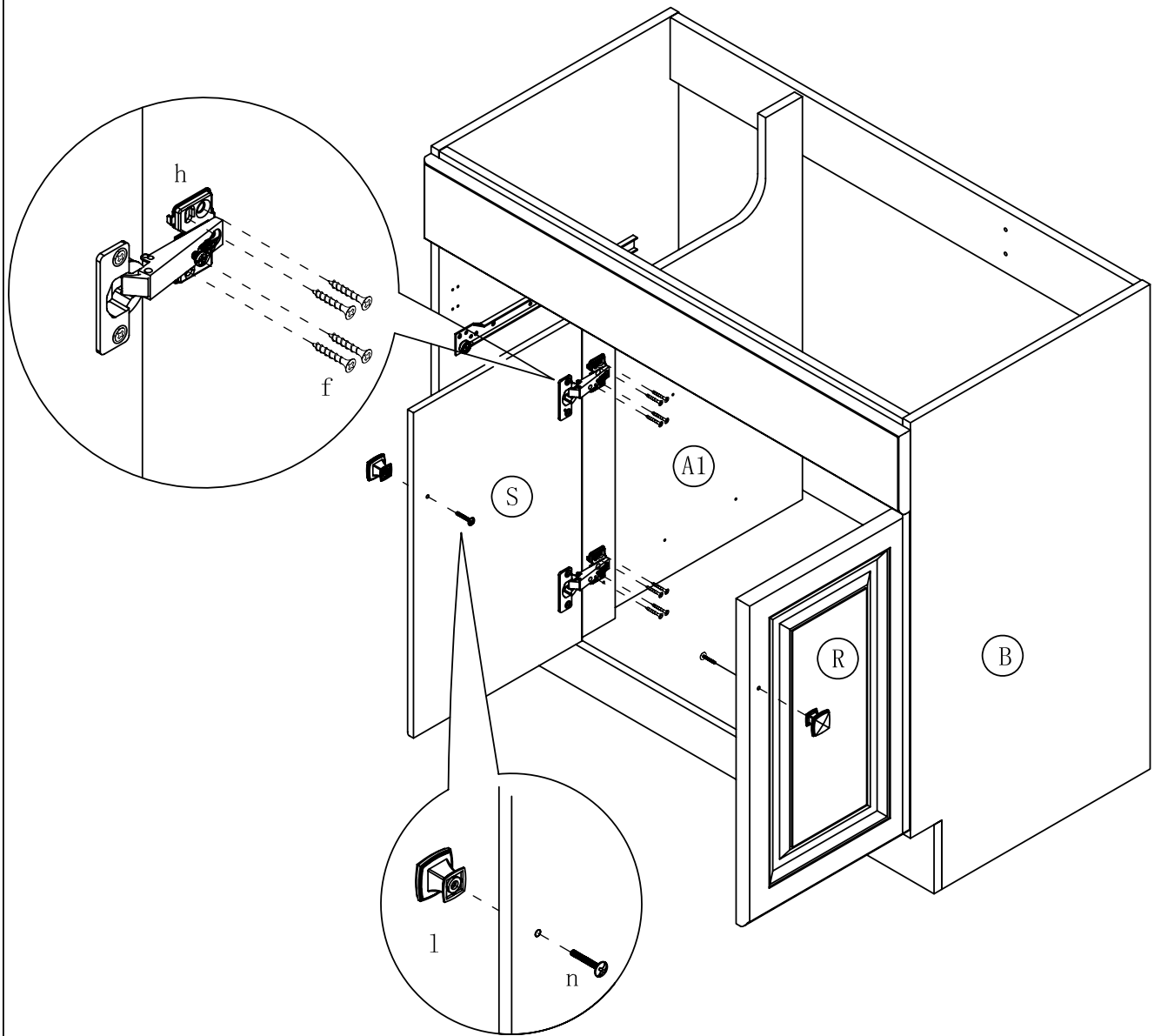

STEP 19

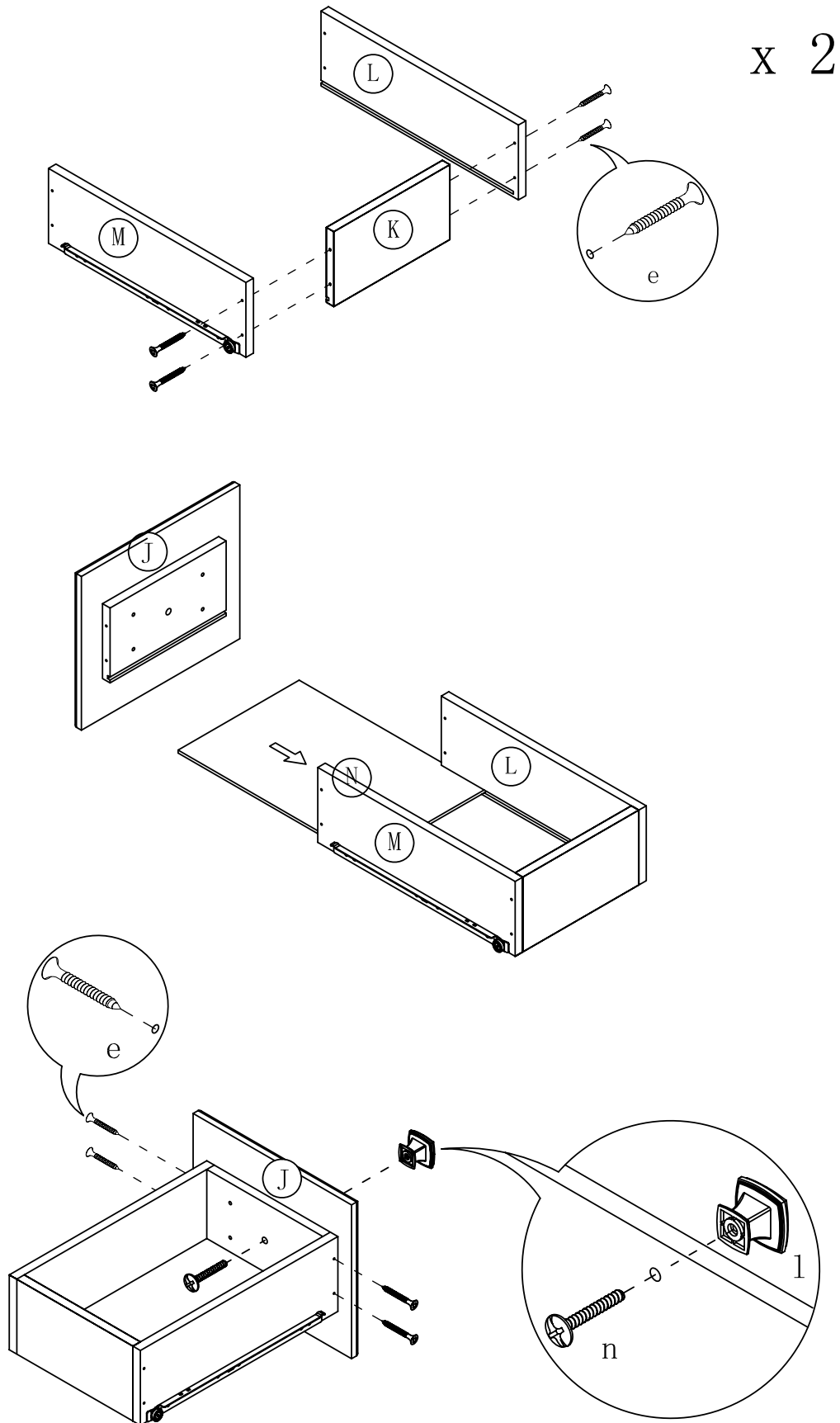



STEP 20

