

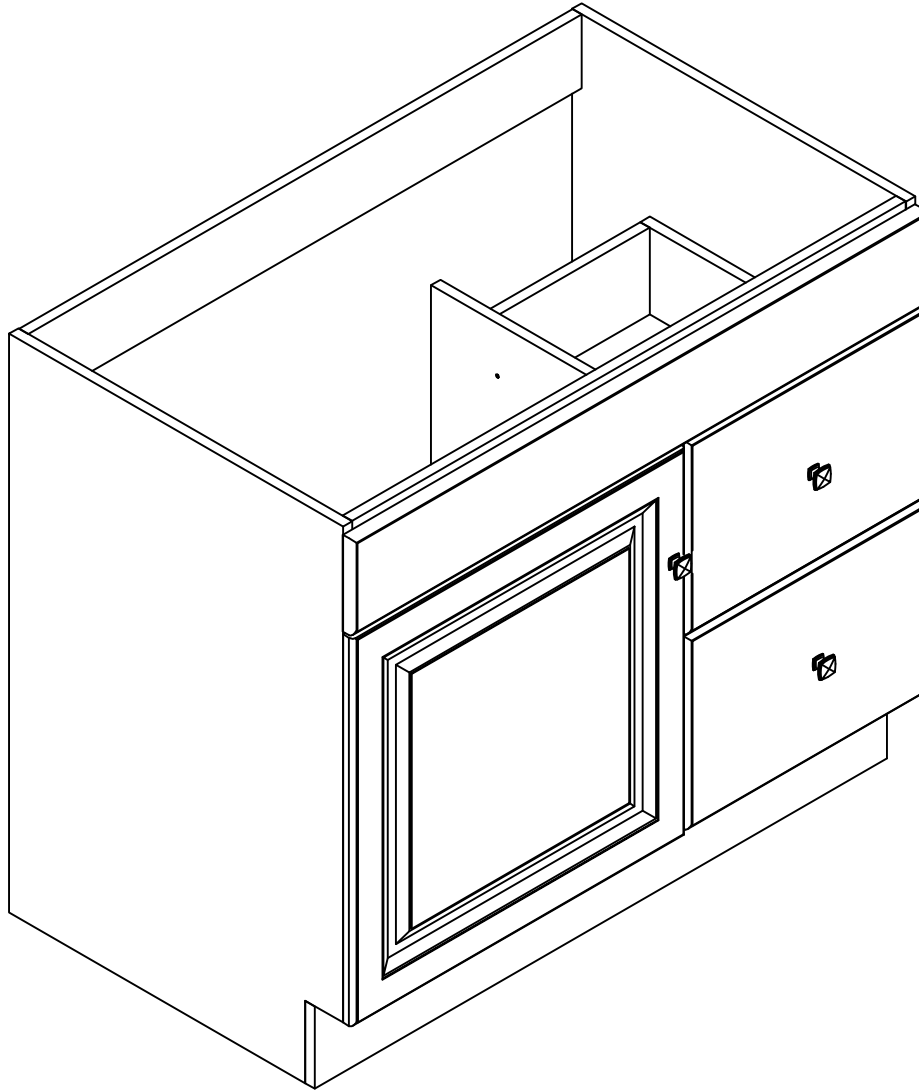

www.todaysdesignhouse.com



584698

ASSEMBLY INSTRUCTIONS

DHI Corp. • 5205 W. Donges Bay Rd. • Mequon, WI 53092 • 800.558.8700

PARTS LIST:

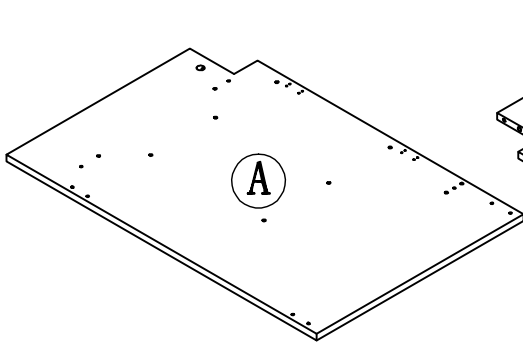

LEFT SIDE PANEL 1PC

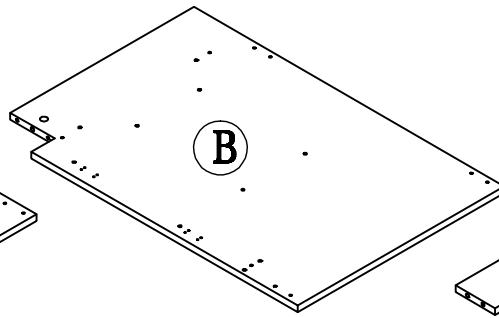

RIGHT SIDE PANEL 1PC

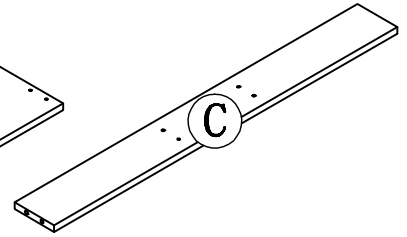

LOWER BACK CROSS BRACE 1PC

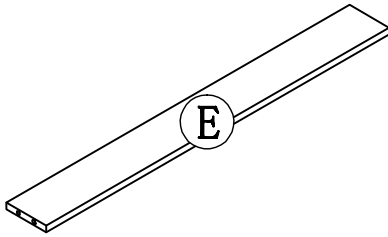

UP BACK CROSS BRACE 1PC

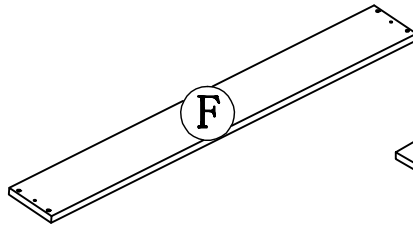

TOE KICK PANEL 1PC

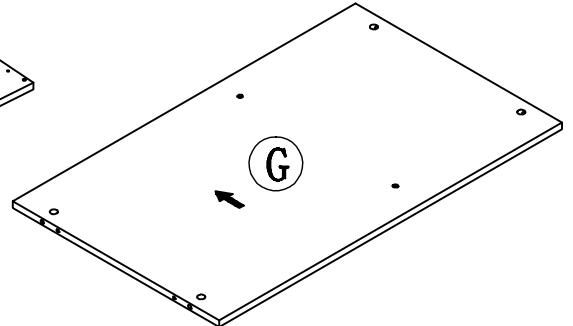

BOTTOM PANEL 1PC

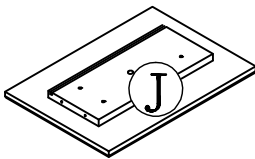

DRAWER FRONT 2PCS

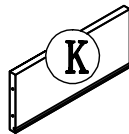

DRAWER BACK PANEL 2PCS

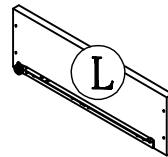

DRAWER LEFT SIDE PANEL 2PCS

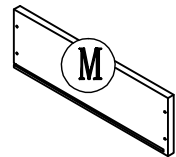

DRAWER RIGHT SIDE PANEL 2PCS

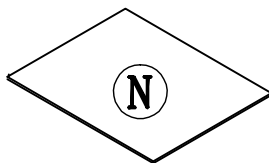

DRAWER BOTTOM PANEL 2PCS

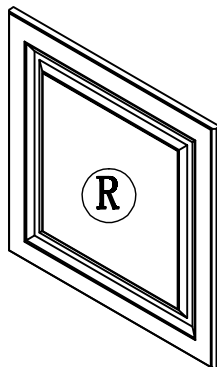

DOOR 1PC

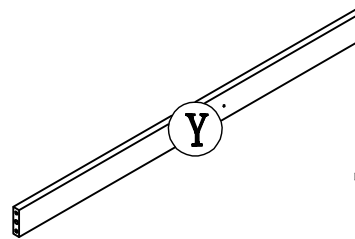

FRONT CROSS BRACE 1PC

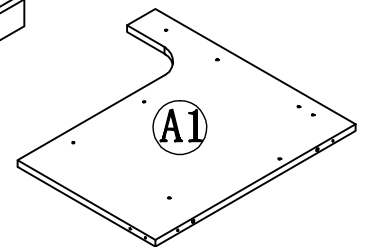

PARTITION 1PC

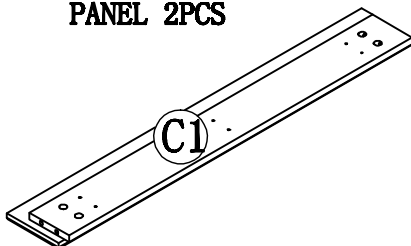

FALSE DRAWER FRONT 1PC

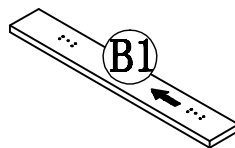

SMALL PARTITION 1PCS

HARDWARE LIST:



a. WOOD DOWEL 14PCS

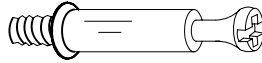

b. CAM LOCK SCREW
20PCS

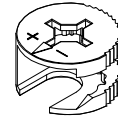

c. CAM LOCK 20PCS



d. 1" L FLAT HEAD
SCREW 4PCS

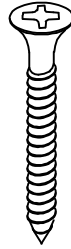

e. 1-1/2" L FLAT HEAD
SCREW 19PCS



f. 5/8" L FLAT HEAD SCREW
12PCS

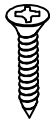

g. 1/2" L FLAT HEAD
SCREW 12PCS

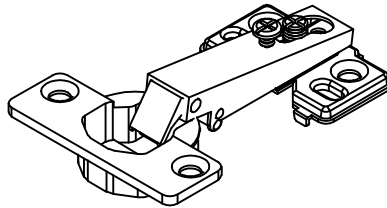

h. HINGE 2PCS

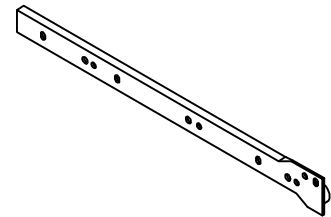

i. LEFT SIDE DRAWER
GUIDE 2PCS

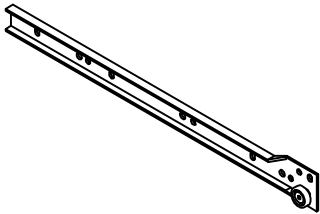

j. RIGHT SIDE DRAWER
GUIDE 2PCS

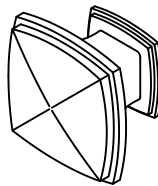

l. KNOB 3PCS

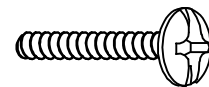

n. KNOB BOLT 3PCS



o. WRENCH 1PC



p. GLUE 1PC

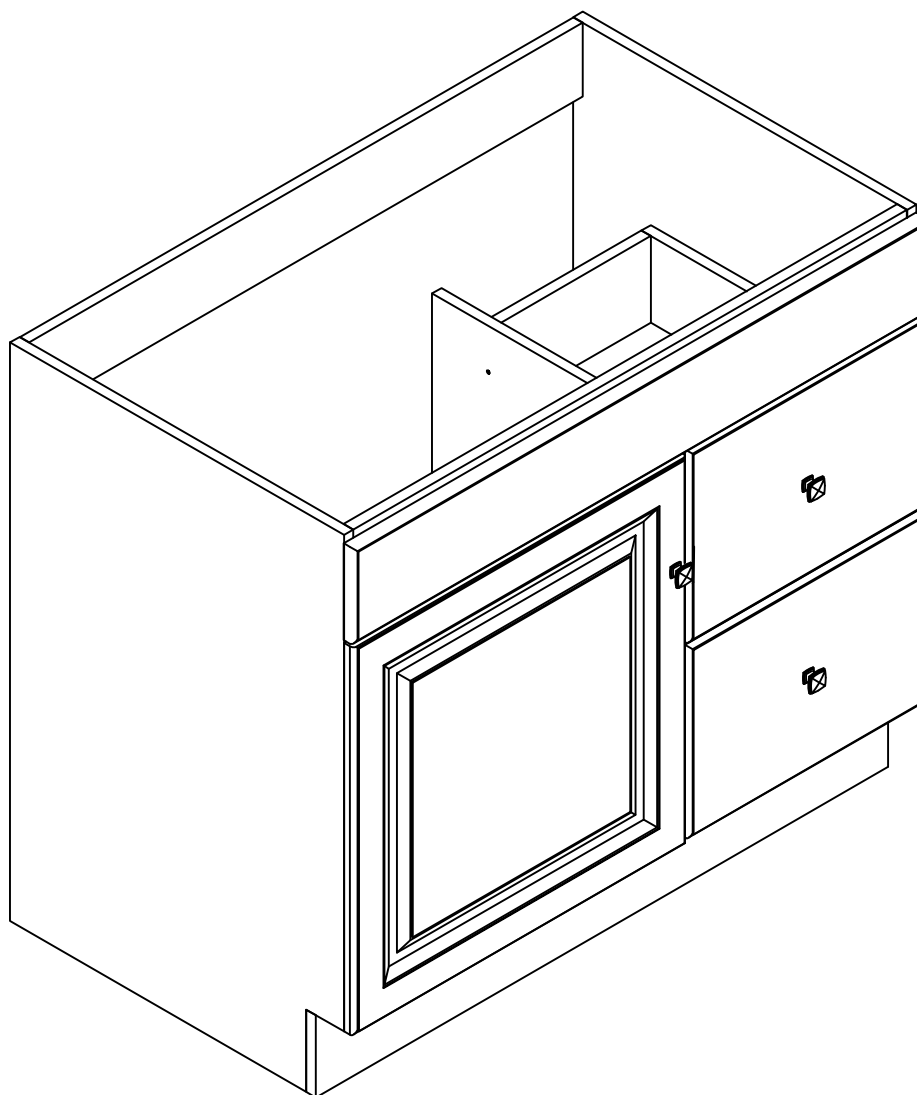

**PLEASE FOLLOW STEP1~STEP 10 IF YOU
WOULD LIKE THE DOOR INSTALL ON THE
LEFT SIDE AND THE DRAWERS INSTALL
ON THE RIGHT SIDE**

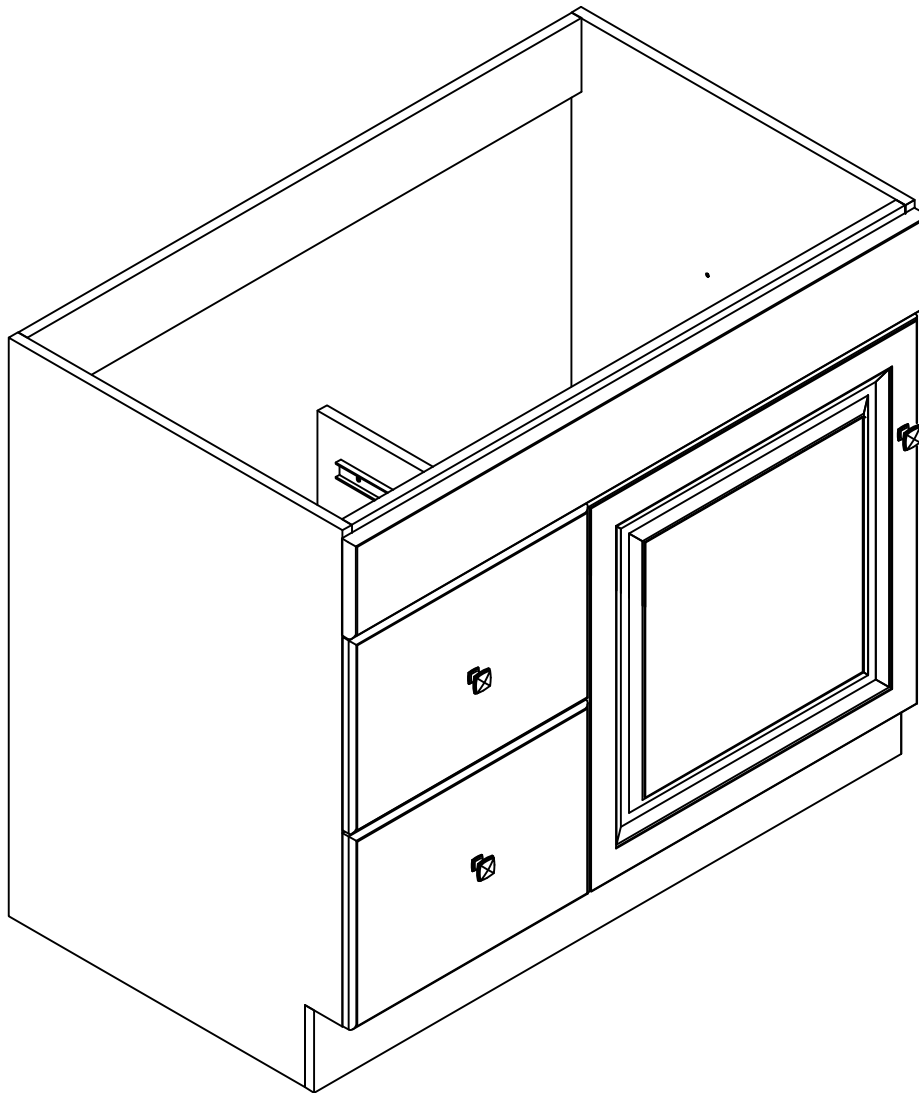

**PLEASE FOLLOW STEP11~STEP 20 IF YOU
WOULD LIKE THE DOOR INSTALL ON THE
RIGHT SIDE AND THE DRAWERS INSTALL
ON THE LEFT SIDE**

STEP 1

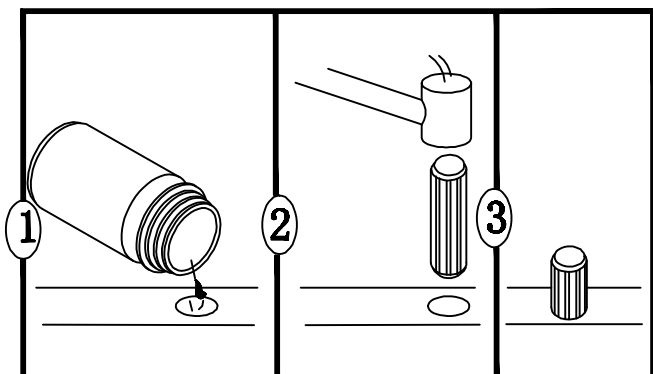
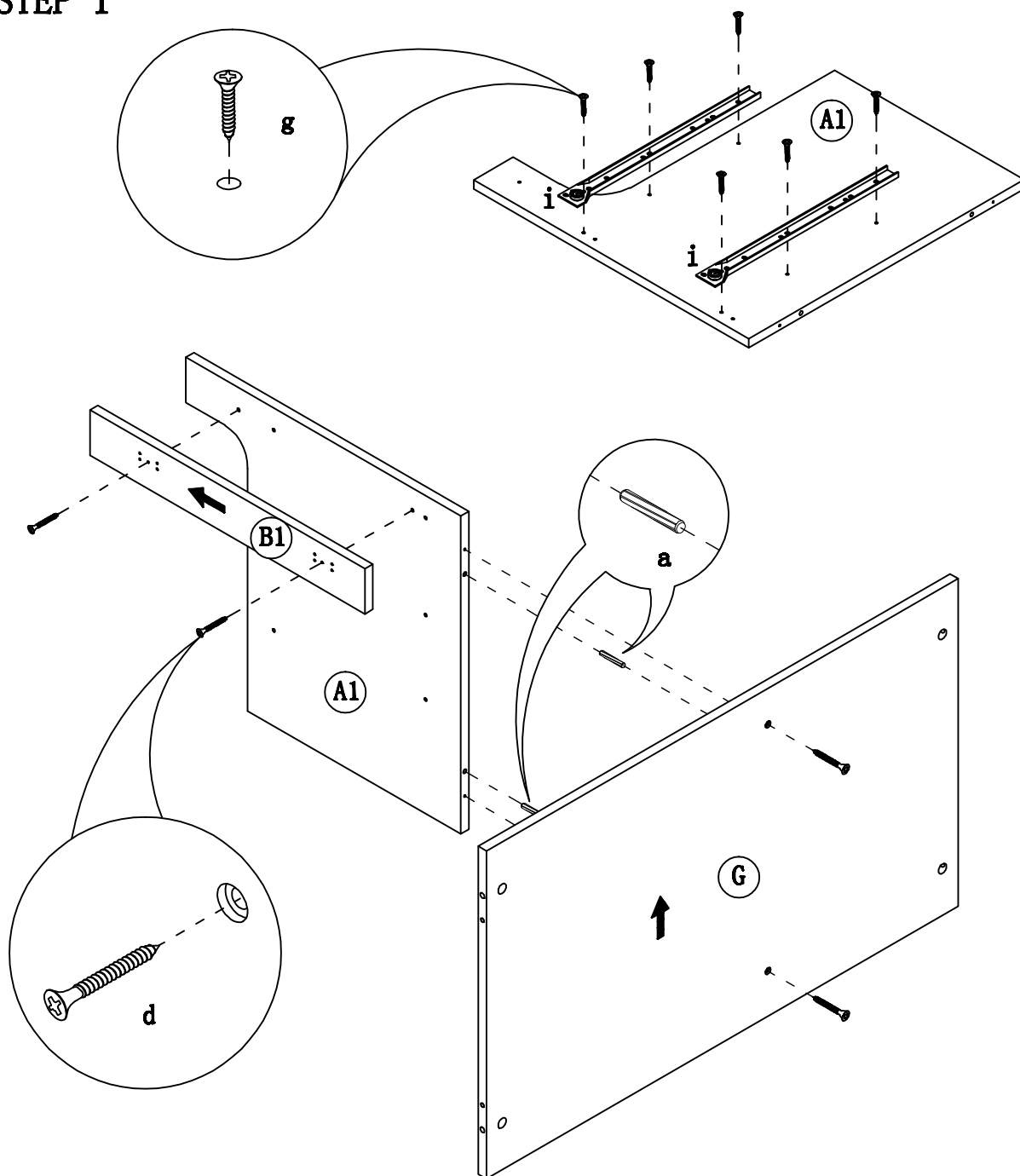

STEP 2

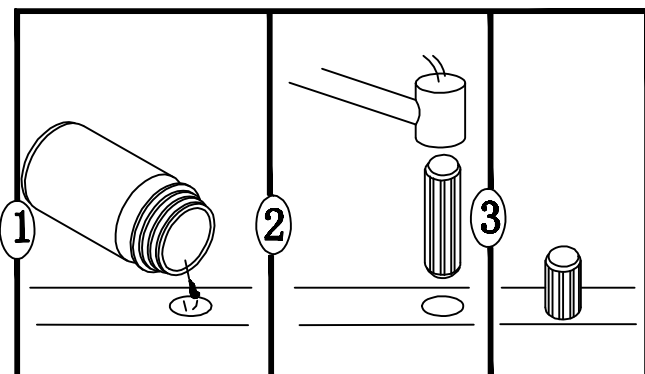
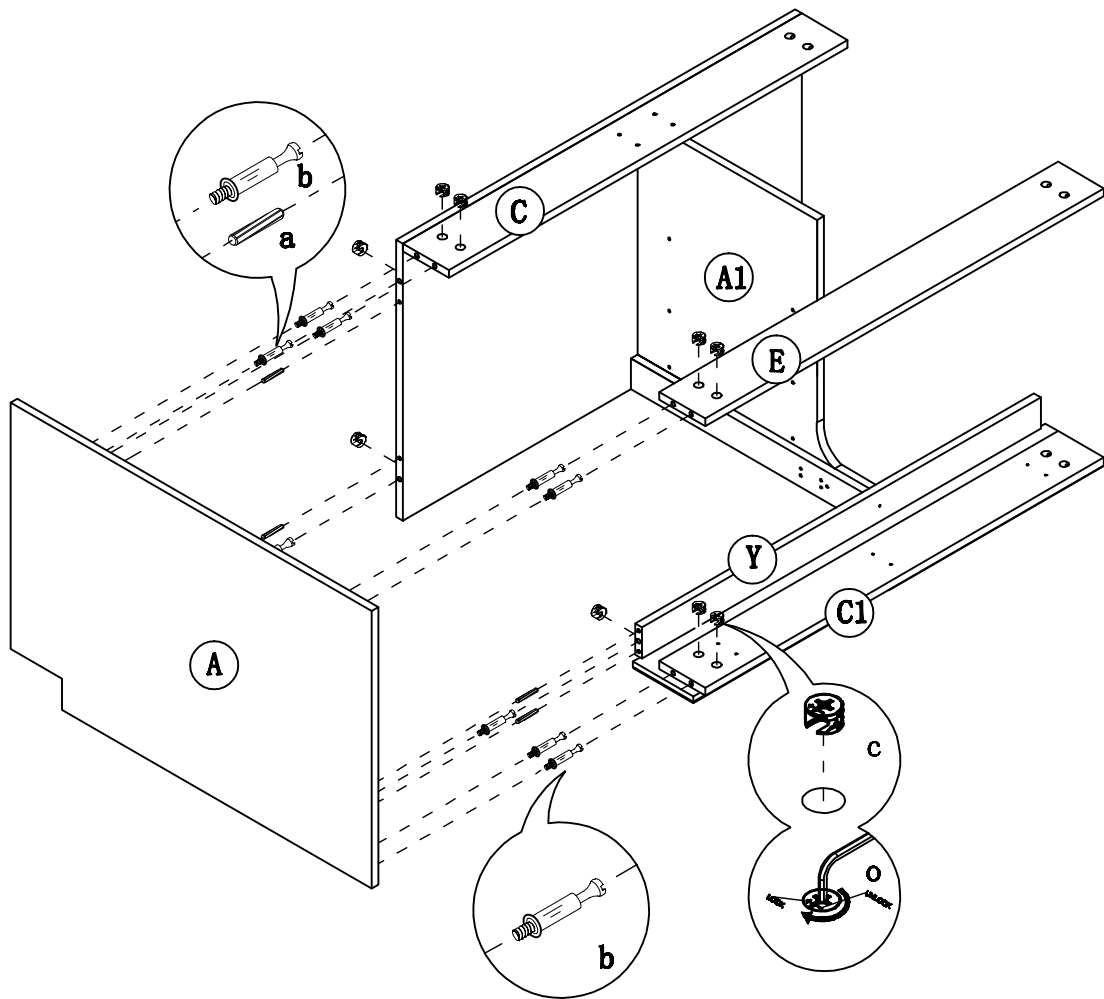

STEP 3

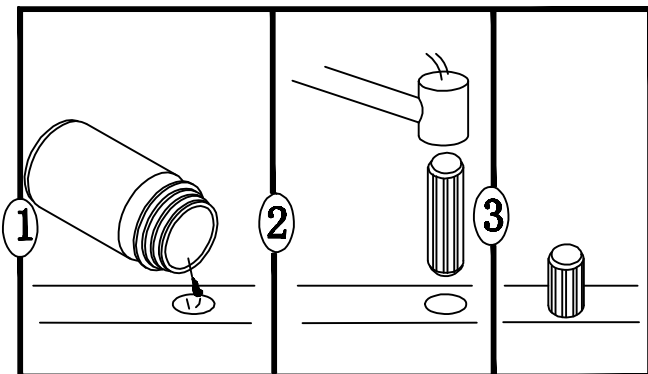
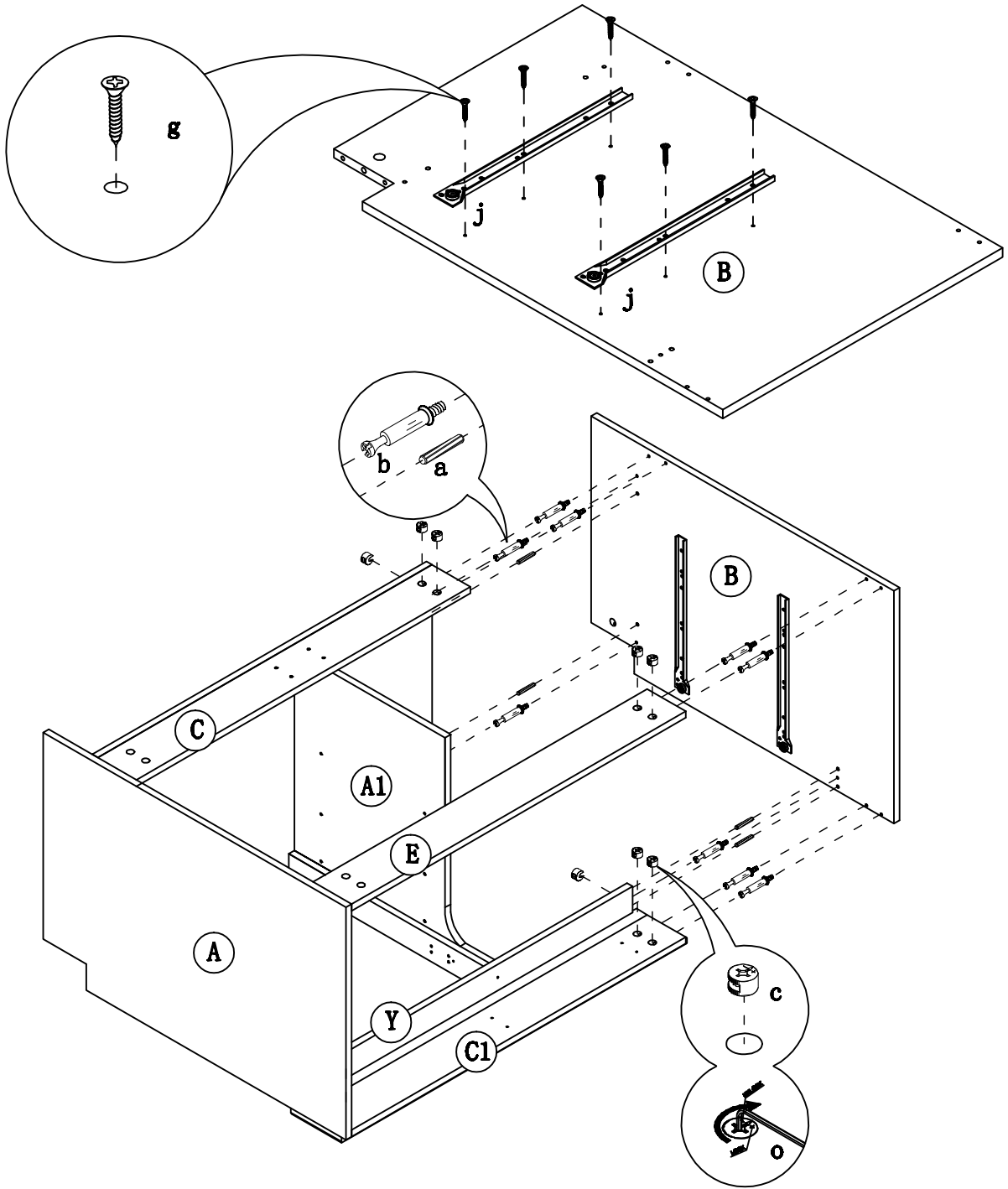

STEP 4

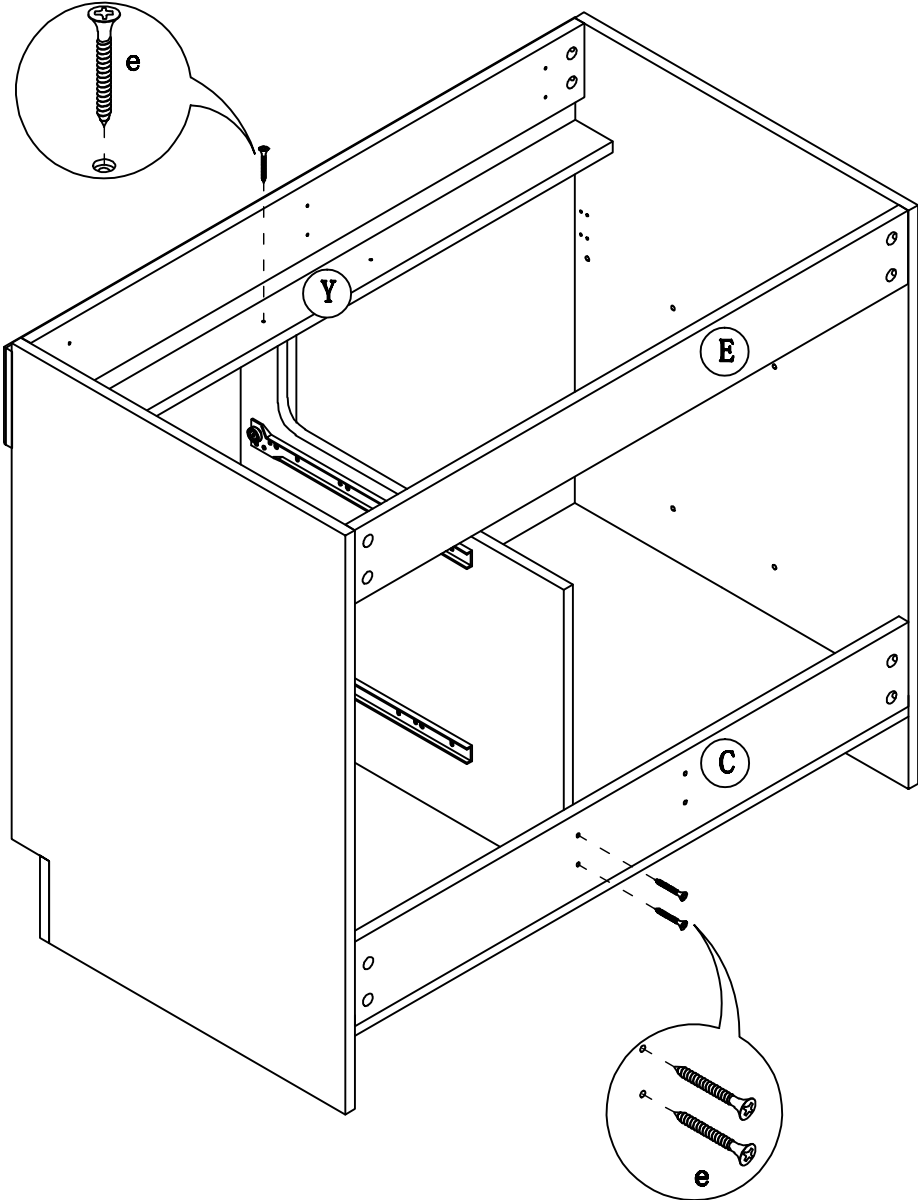

STEP 5

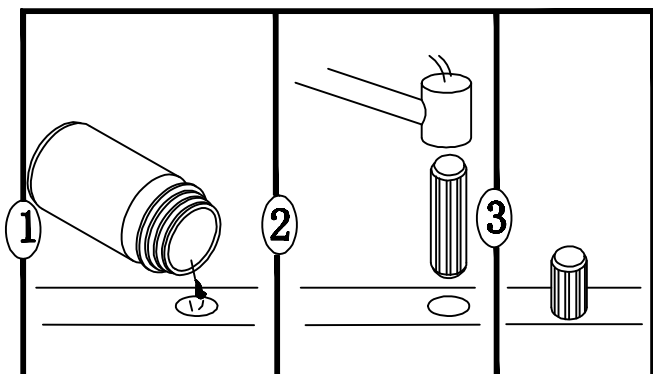
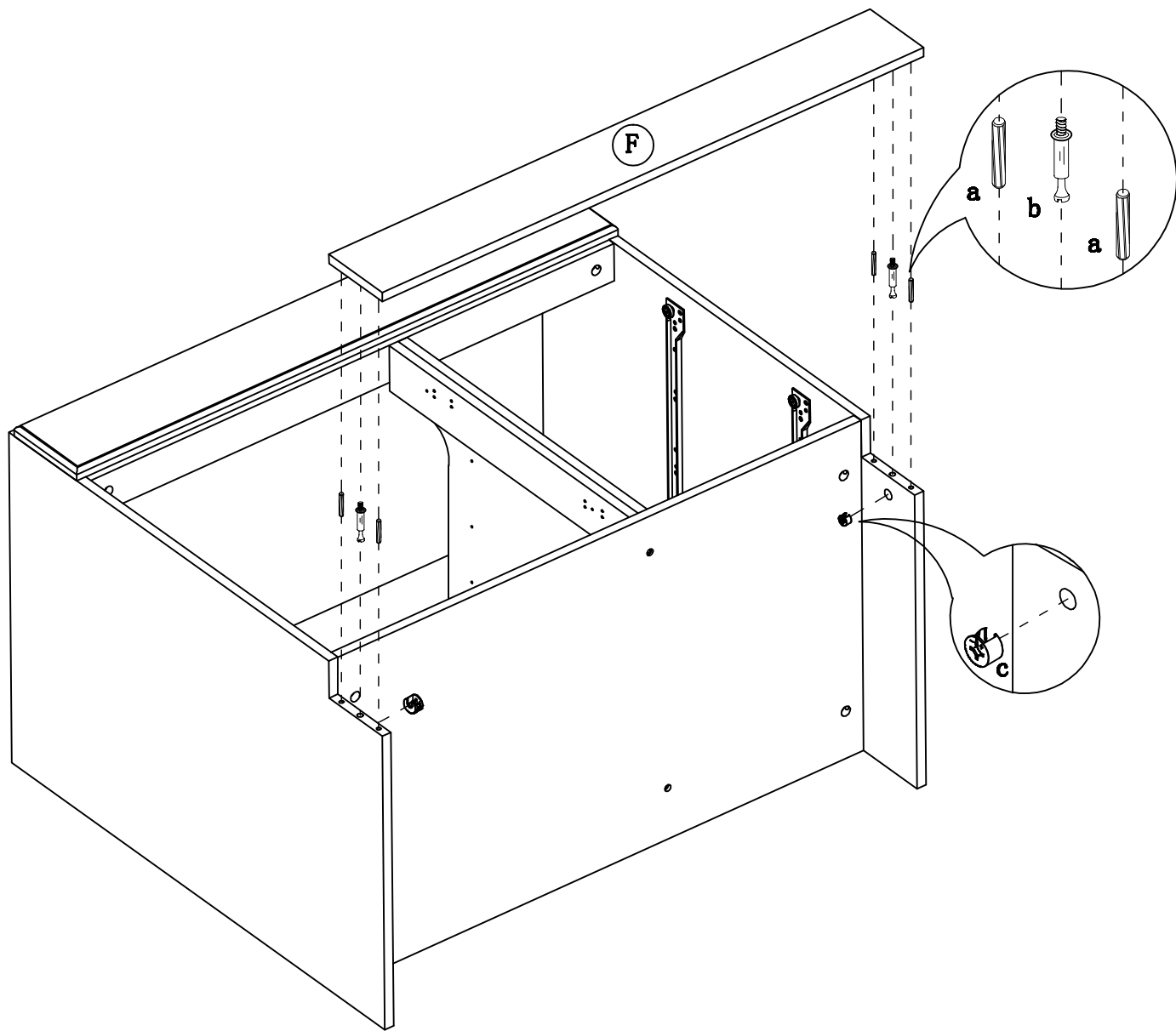

STEP 6

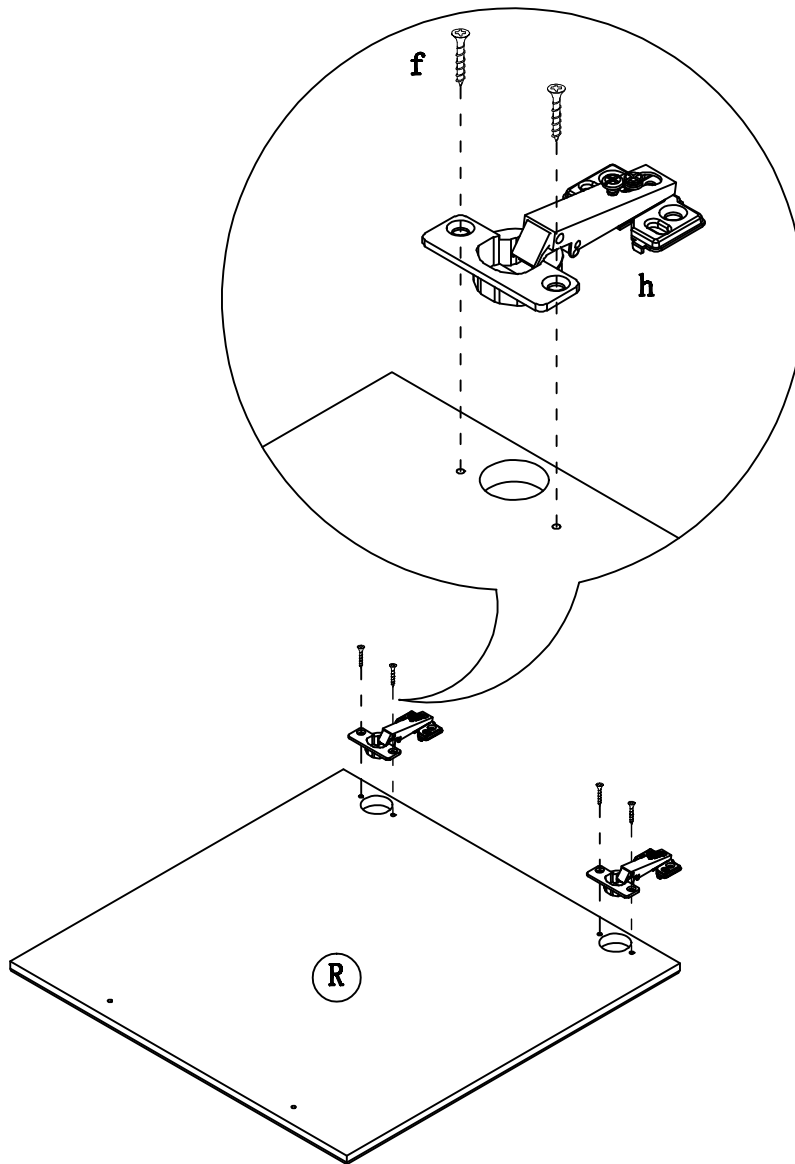

STEP 7

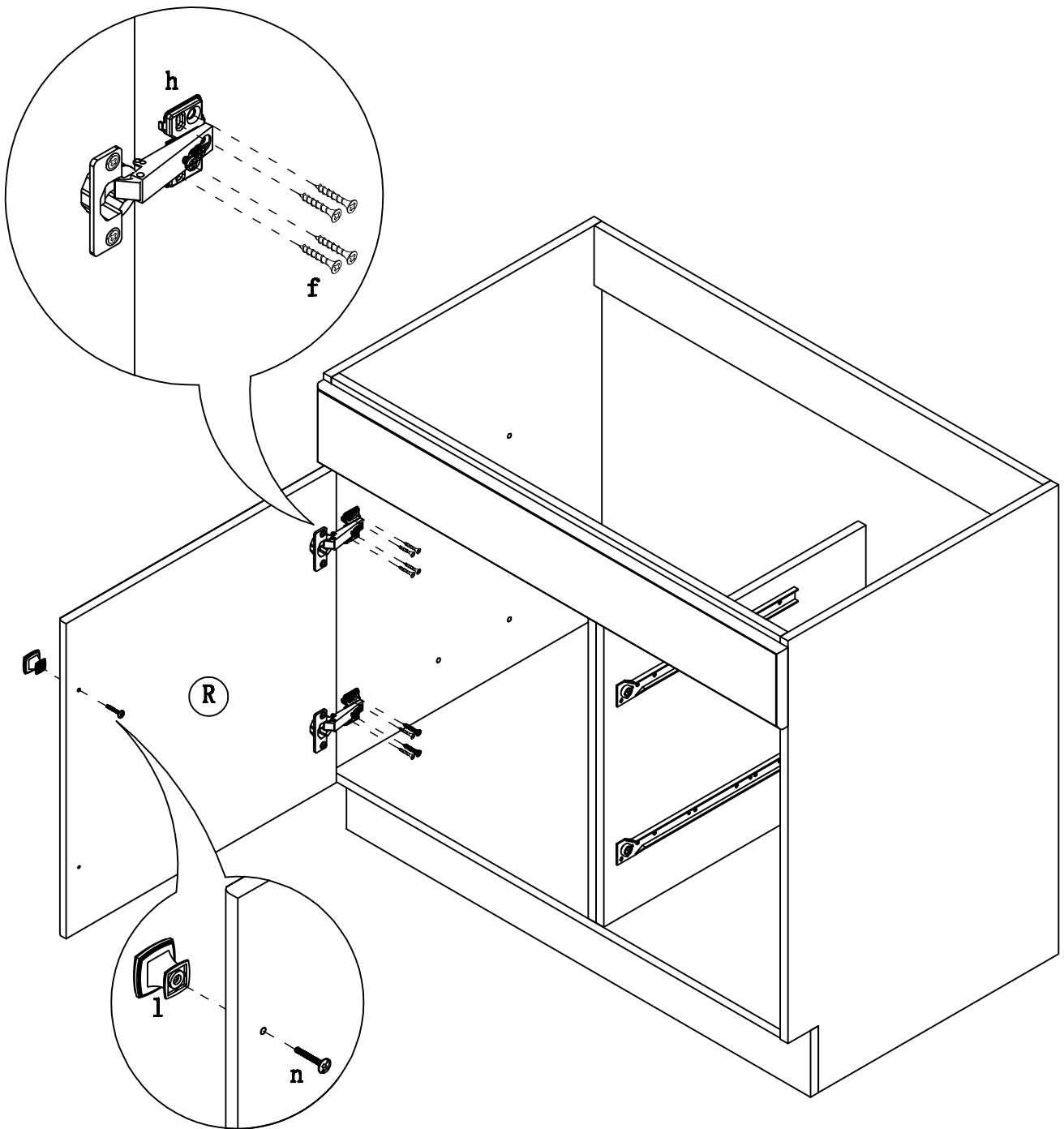

**PLEASE FOLLOW STEP 7 IF
YOU WOULD LIKE THE
DOOR OPEN FROM THE
LEFT**

STEP 8

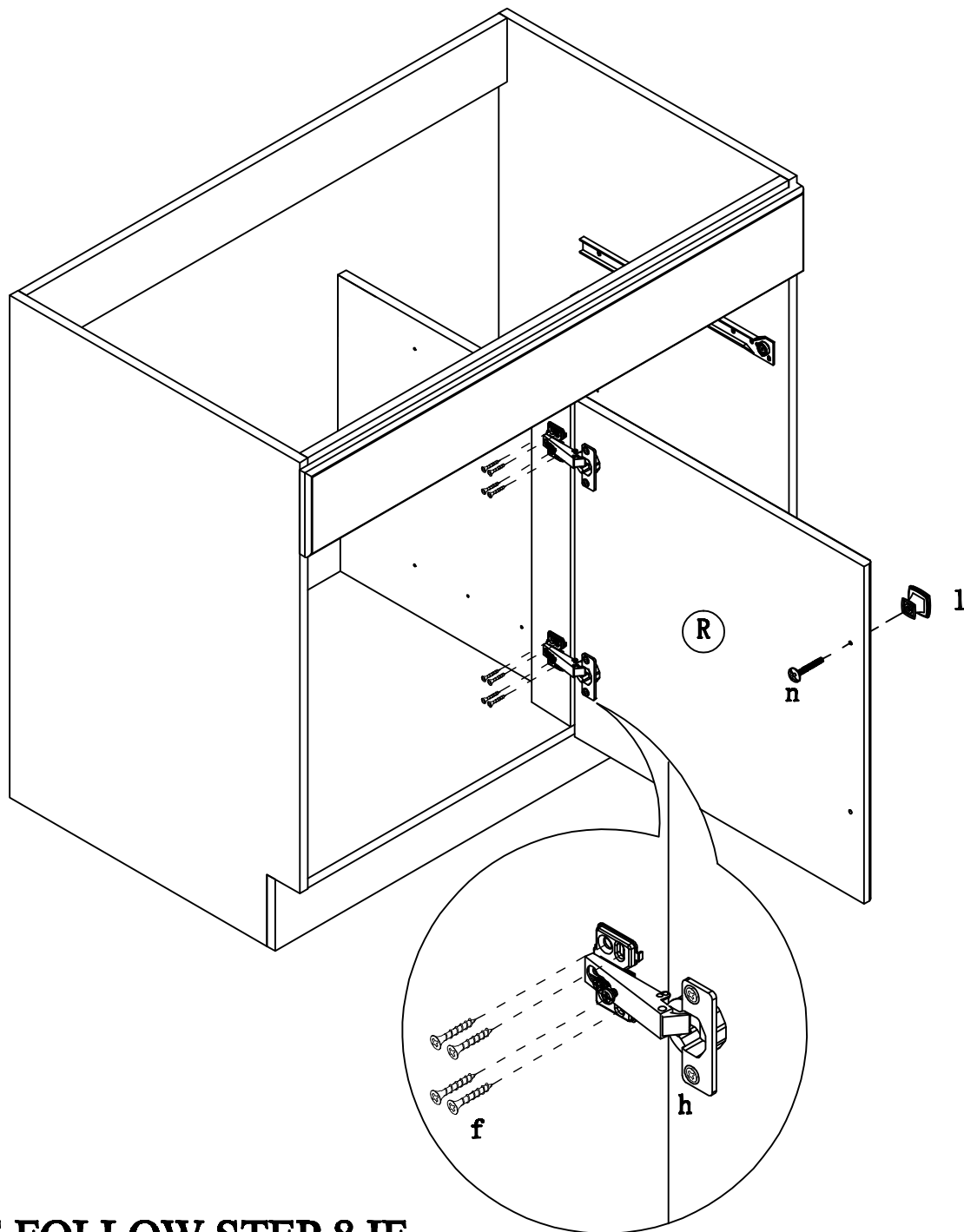

**PLEASE FOLLOW STEP 8 IF
YOU WOULD LIKE THE
DOOR OPEN FROM THE
RIGHT**

STEP 9

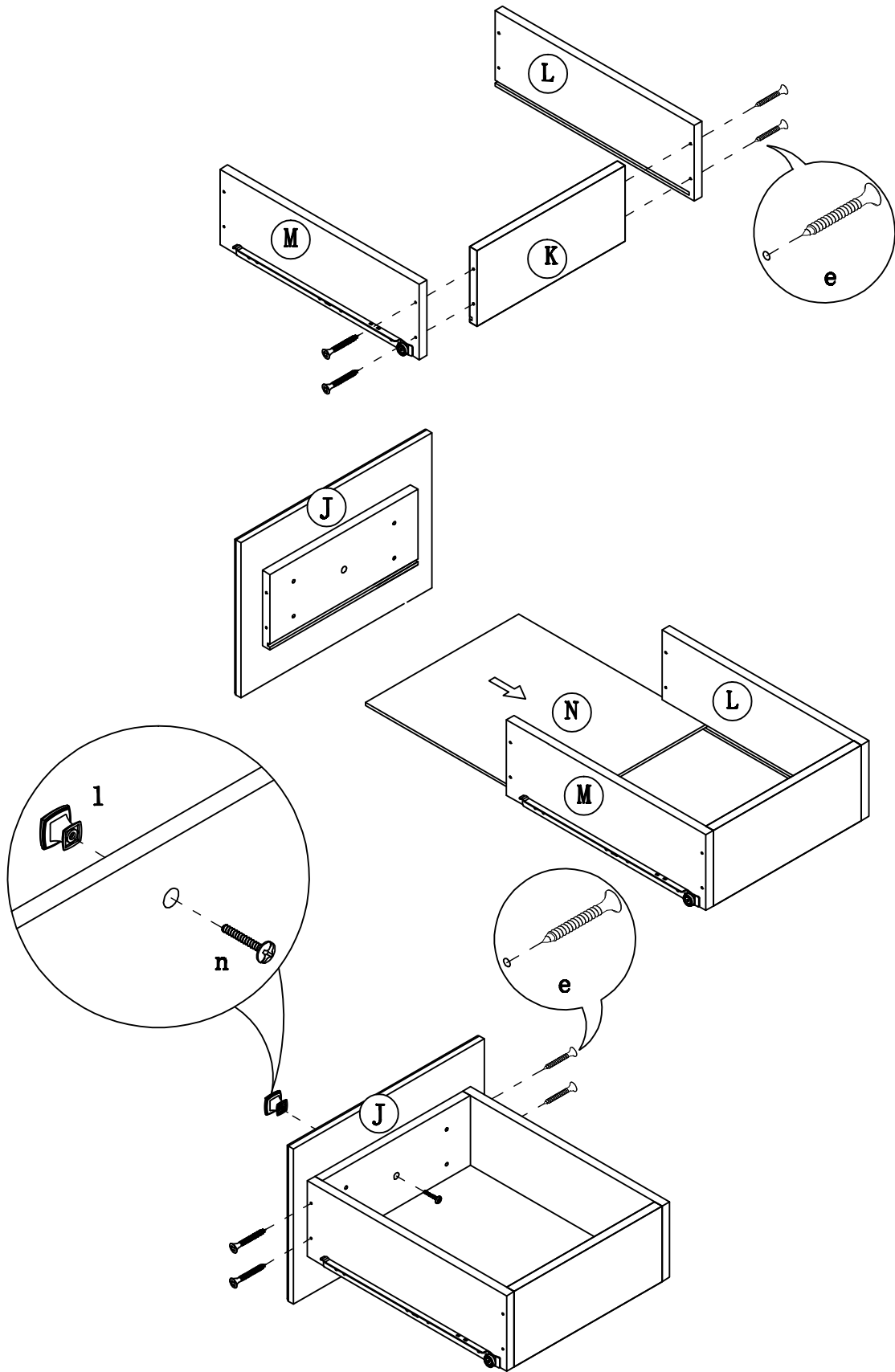

STEP 10

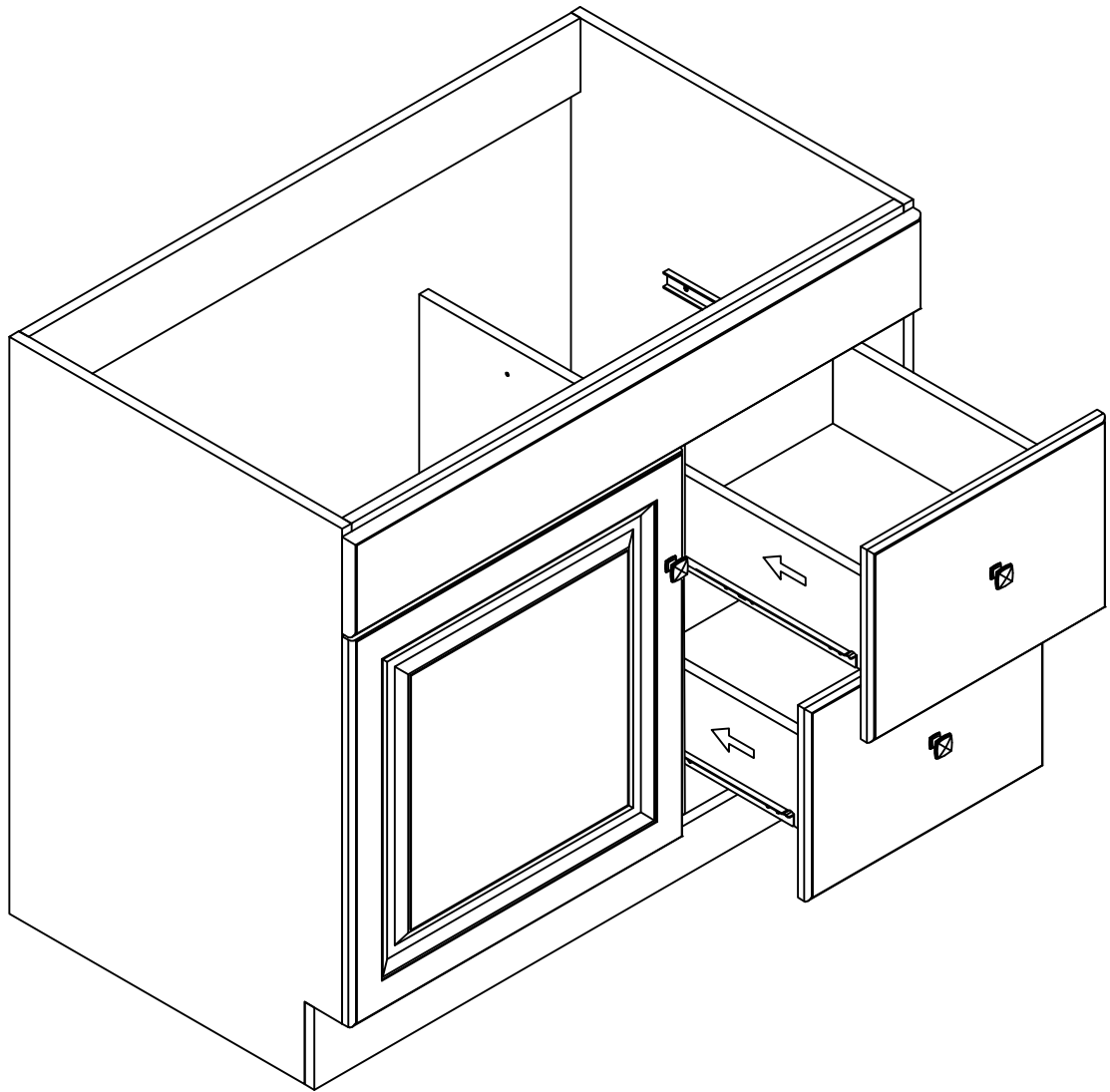

STEP 11

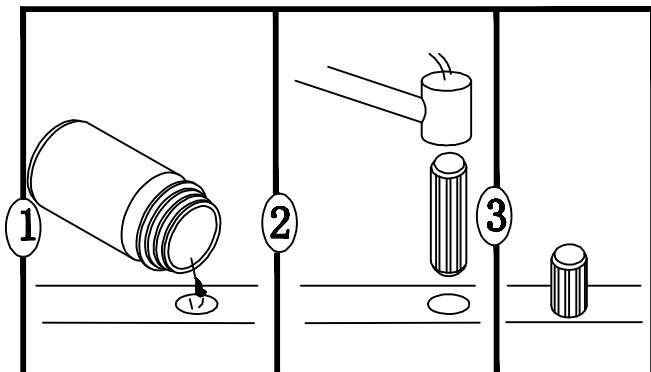
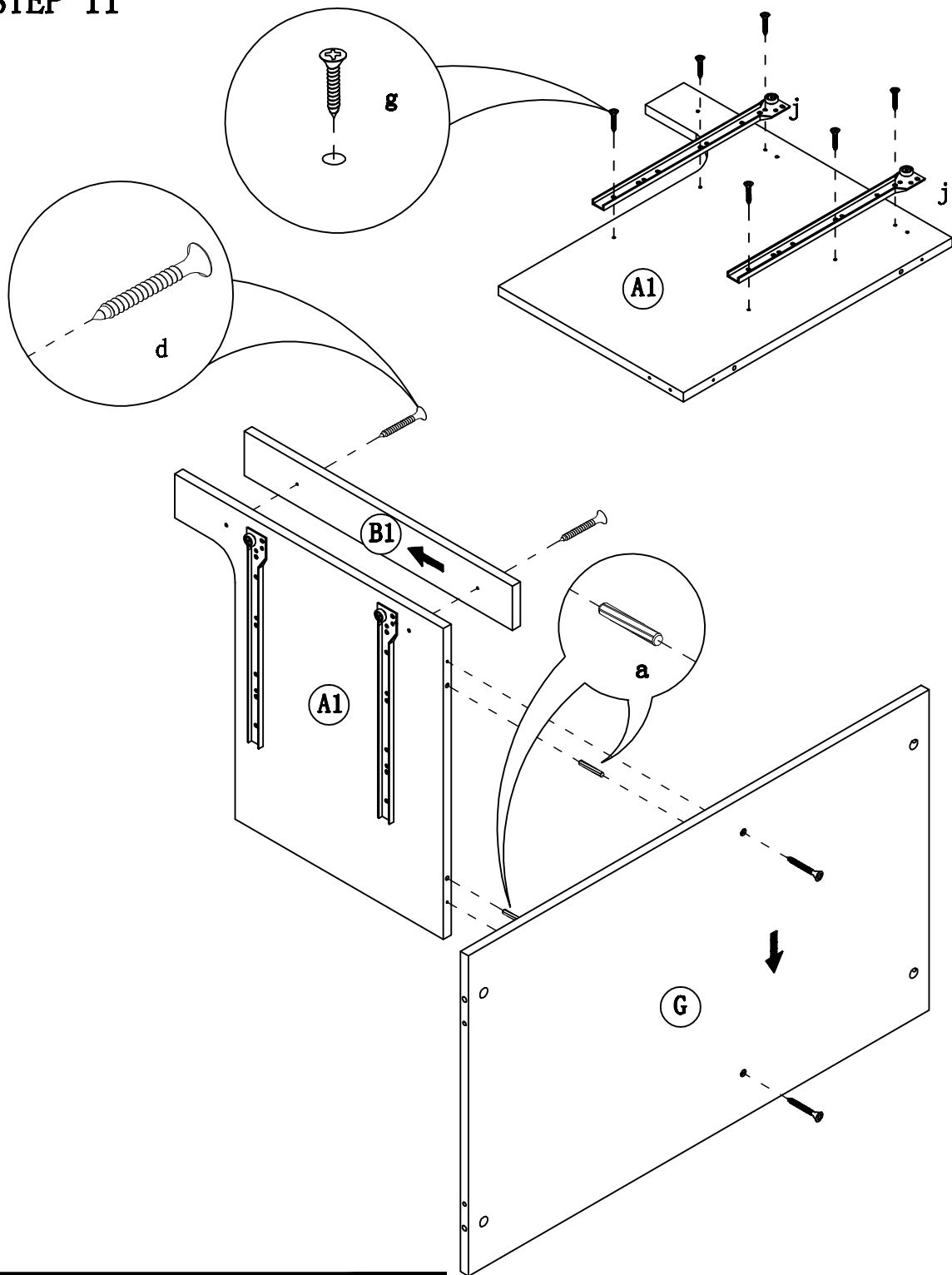

STEP 12

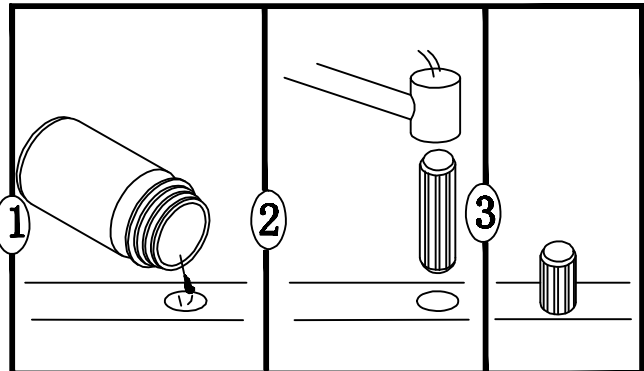
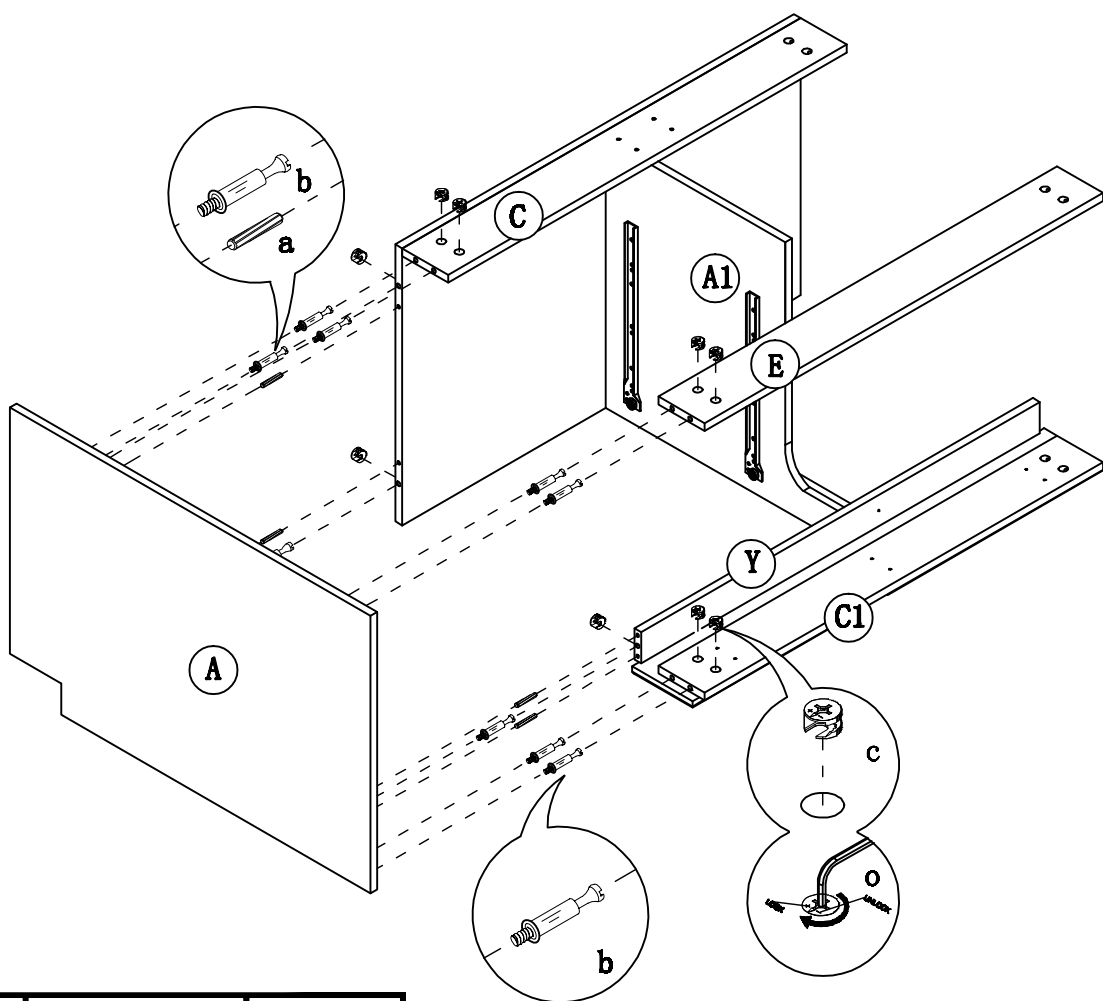
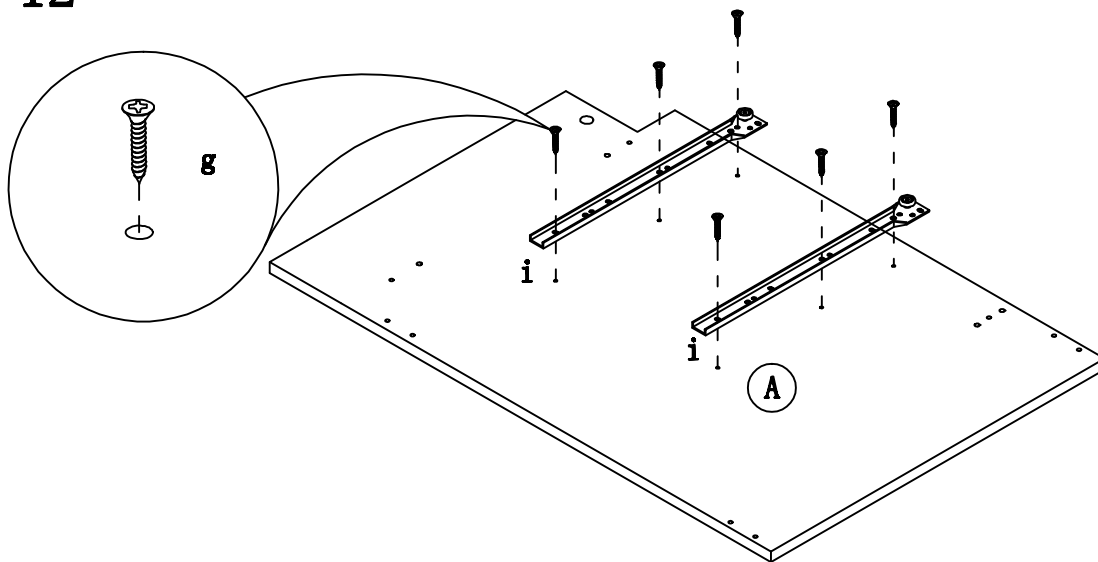

STEP 13

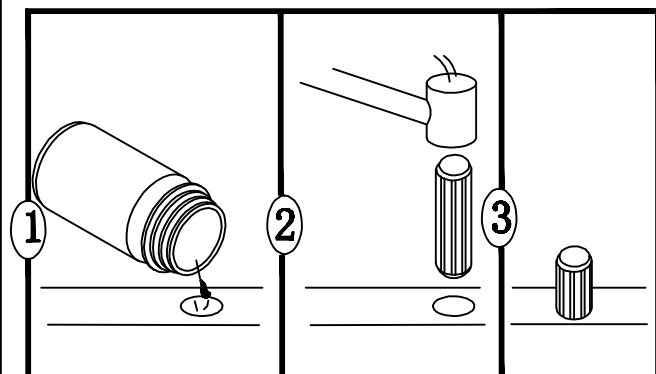
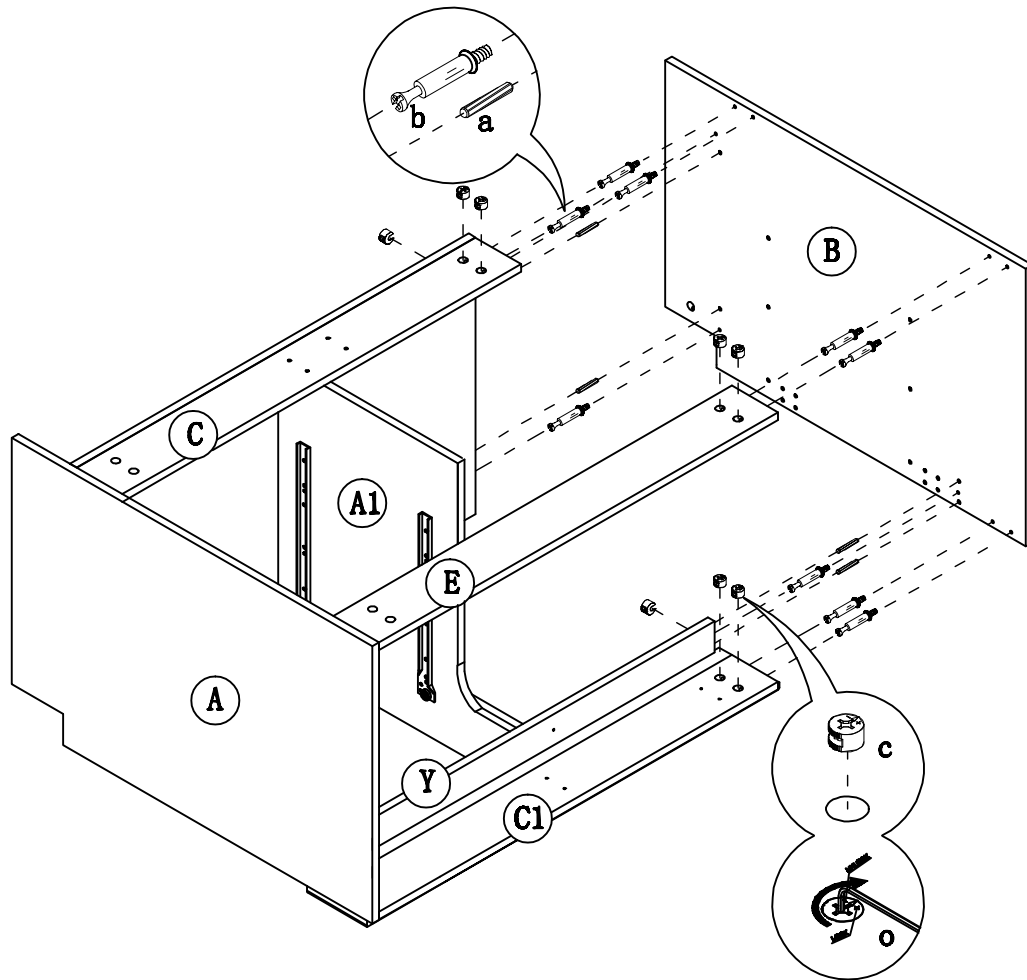

STEP 14

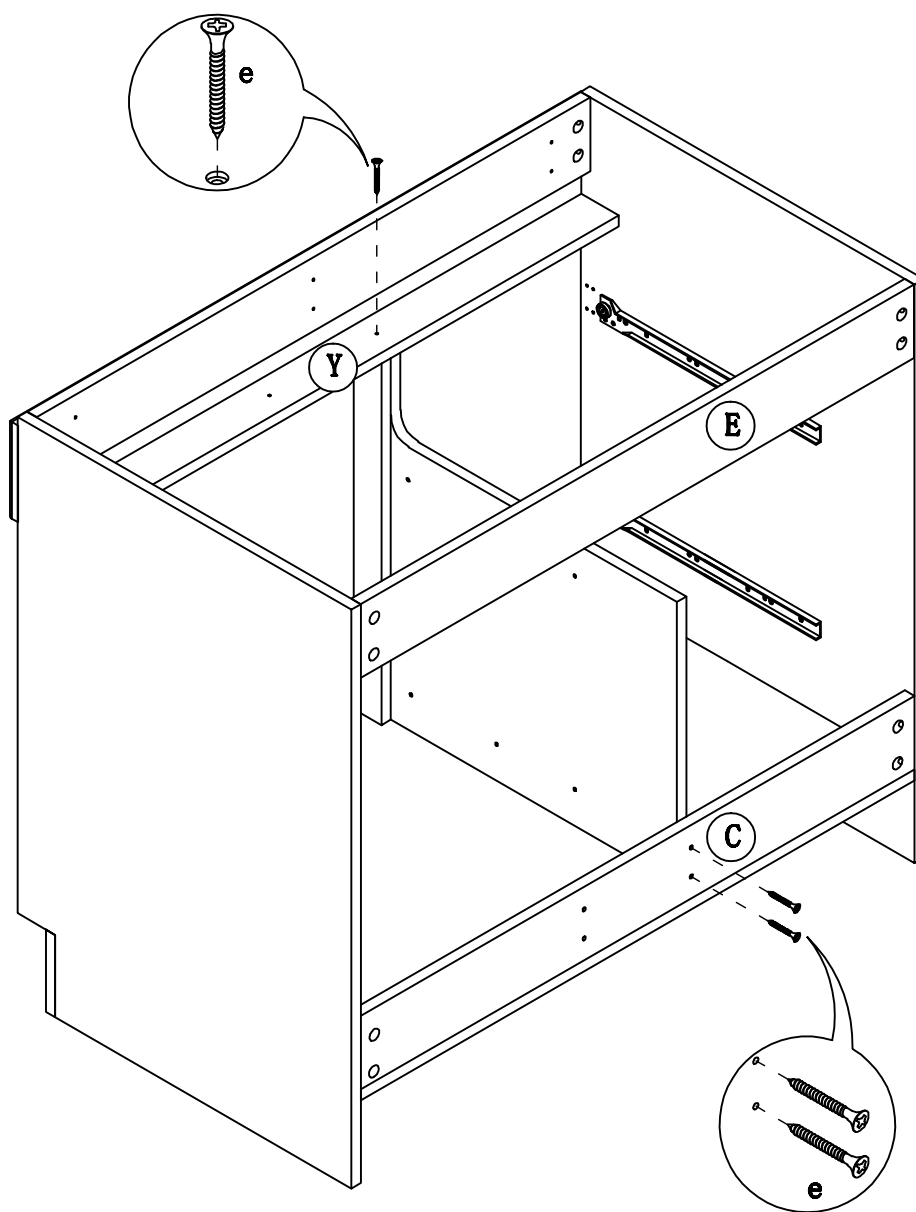

STEP 15

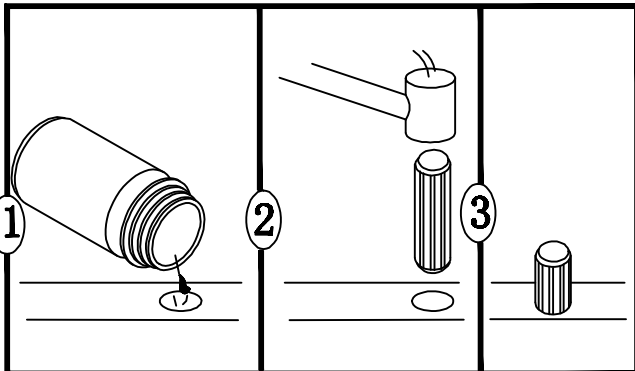
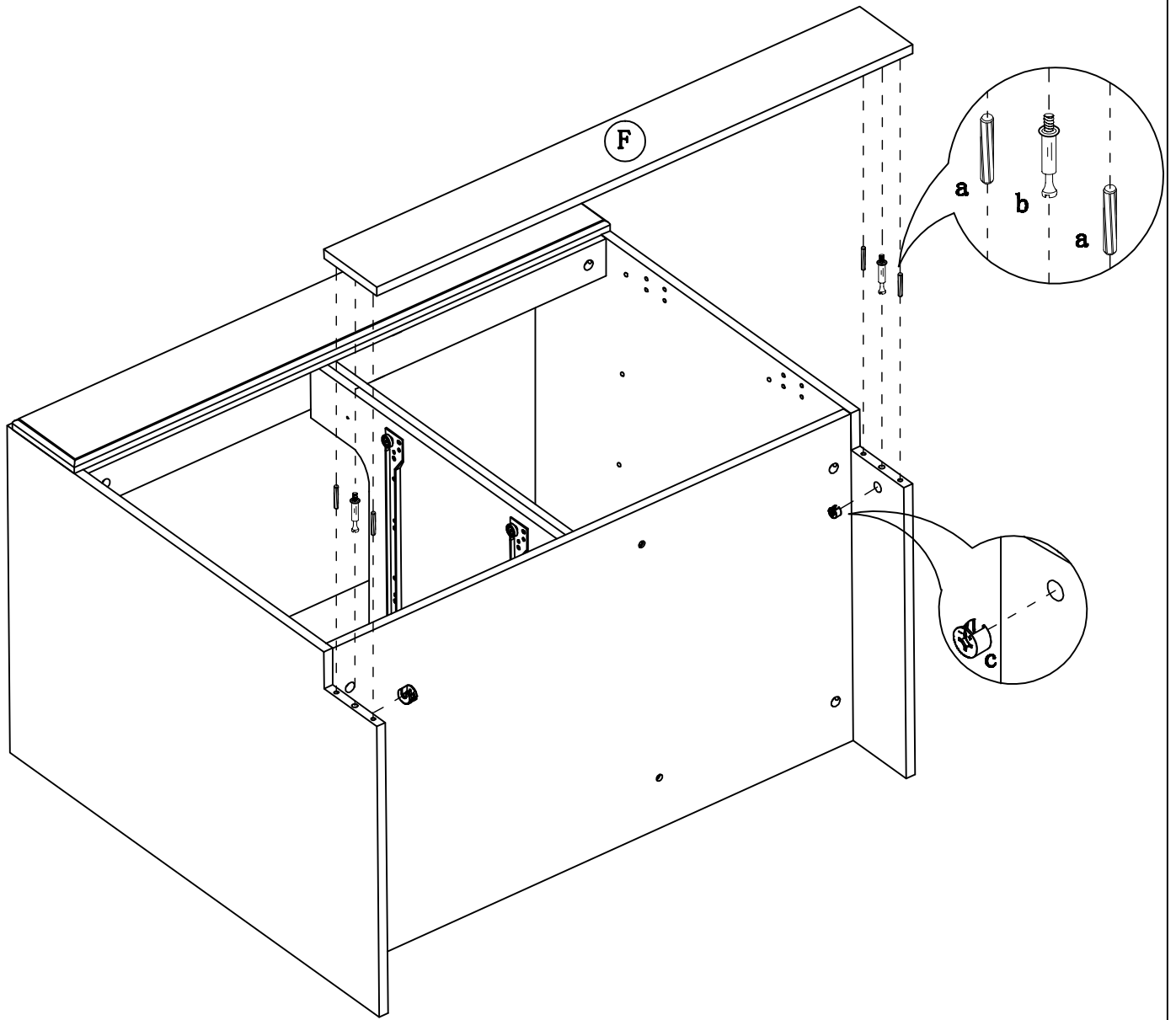

STEP 16

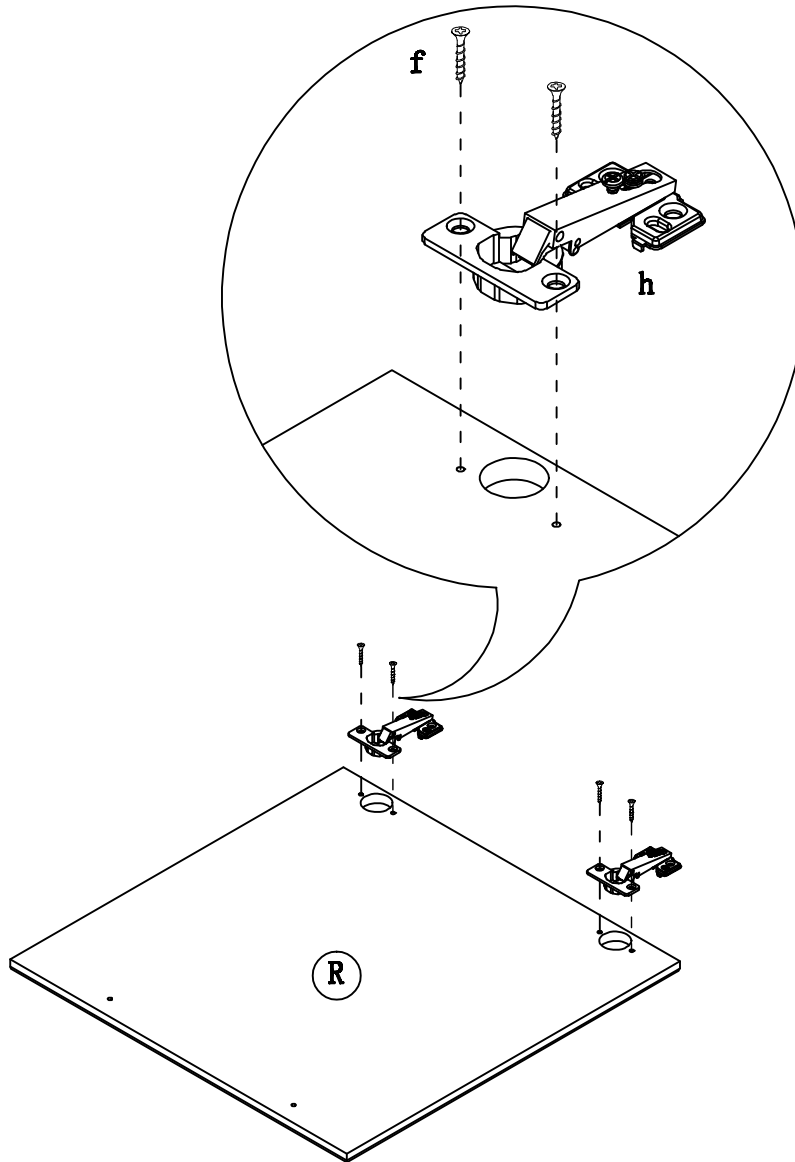

STEP 17

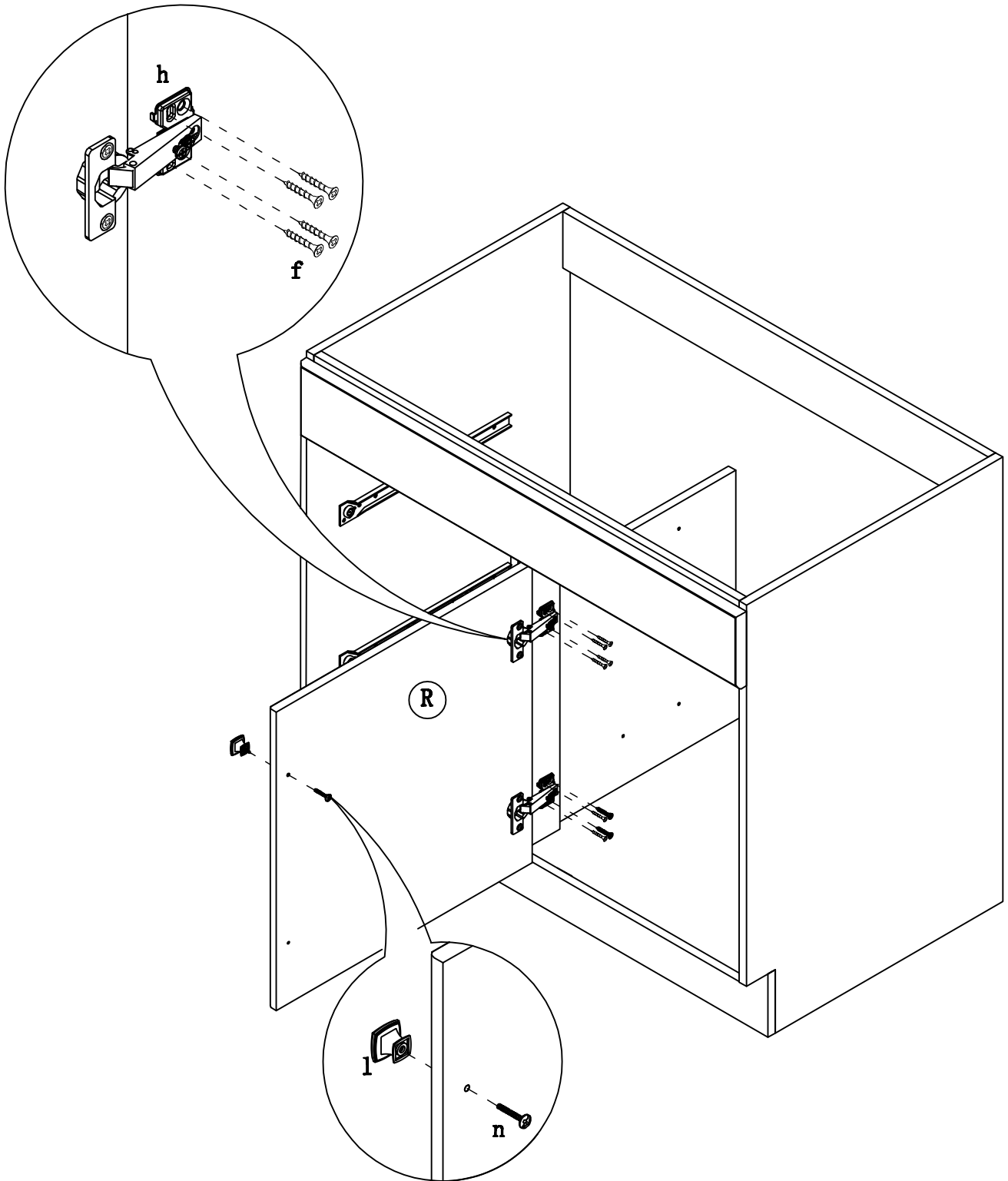

**PLEASE FOLLOW STEP 17 IF
YOU WOULD LIKE THE
DOOR OPEN FROM THE
LEFT**

STEP 18

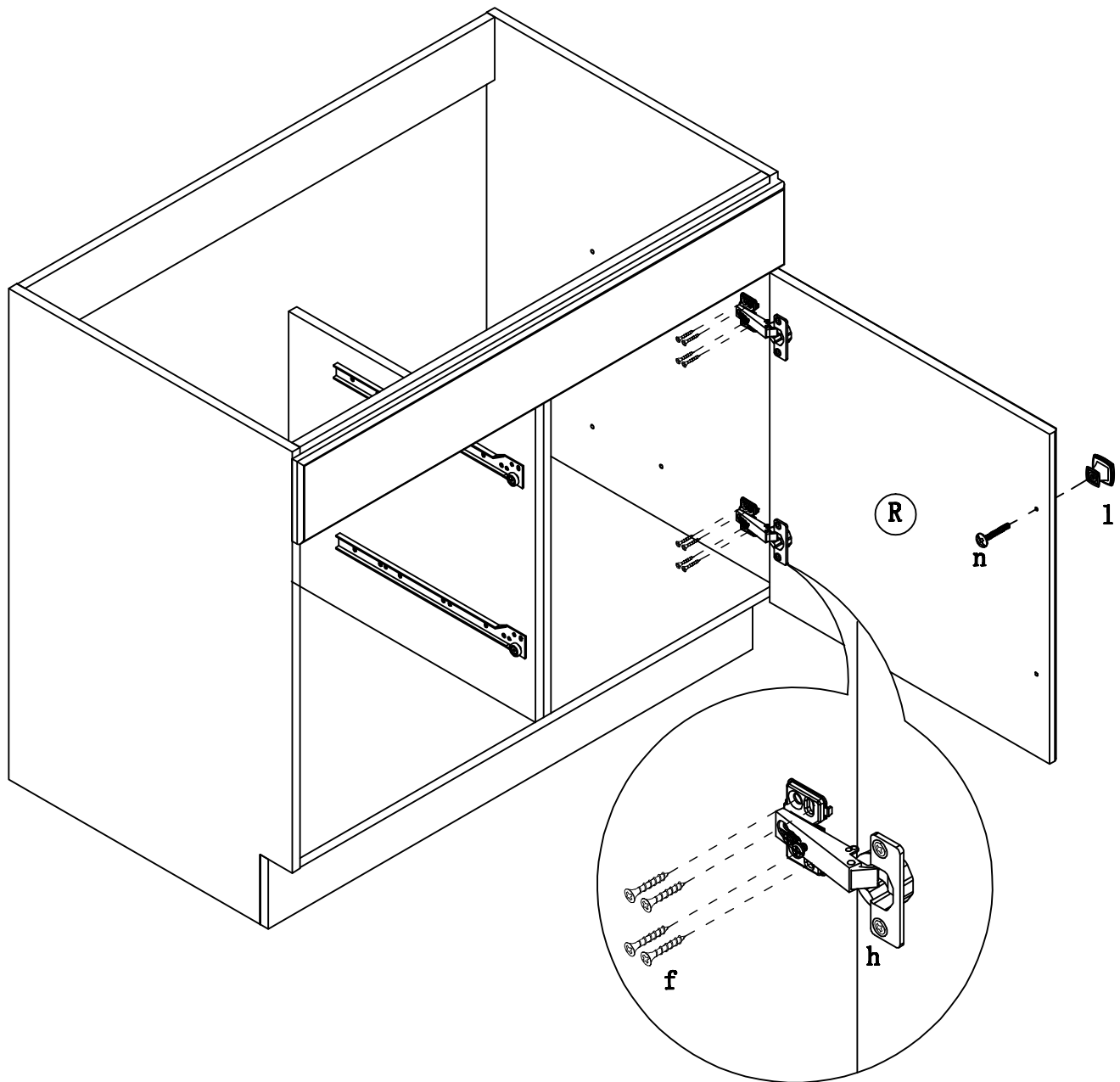

**PLEASE FOLLOW STEP 18 IF
YOU WOULD LIKE THE
DOOR OPEN FROM THE
RIGHT**

STEP 19

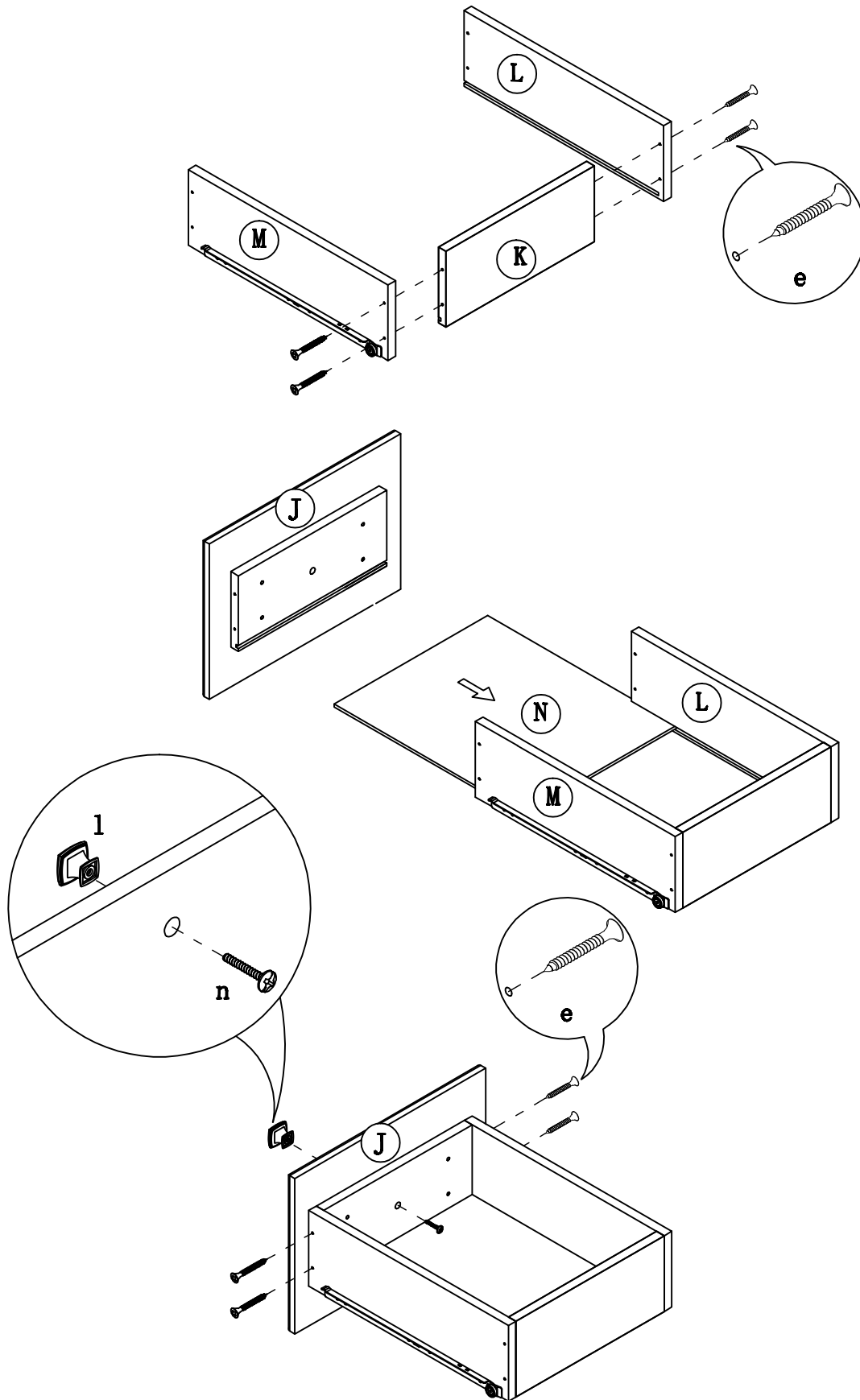

STEP 20

