

Submitted Model No.: \_\_\_\_\_  
 Specific Features: \_\_\_\_\_

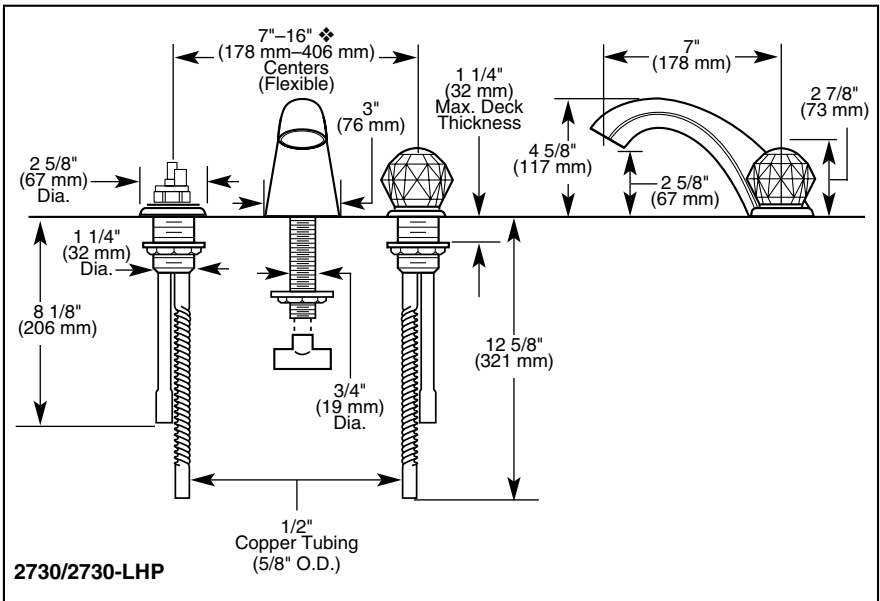

❖ For Lever Handles Use 10"-16" Centers.



# BATH VALVES

- Two Handle Roman Tub Mid-Size Faucet
- Innovations® Series
- Complete Trim and Rough
- Three Hole Installation
- Flexible Widespread Mount on Deck or Ledge
- 7" (178 mm) Long, 4 5/8" High (117 mm) Rigid Slip-On Spout
- Temperature and Volume Controlled with Handles

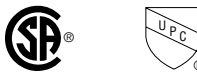

**COMPLIES WITH:**

- ASME A112.18.1
- CSA B125
- ♿ Indicates ADA compliance to CABO/ANSI A117.1
- IAPMO Listed
- CSA Certified

**STANDARD SPECIFICATIONS:**

- Two handle Roman Tub faucet for concealed mounting.
- Clear knob handles with red/blue indicators or LHP—Less Handle Program. See available handle options on back.
- Flexible widespread mount on deck or ledge.
- Solid fabricated brass end valves and spout body.
- 7" (178 mm) long, 4 5/8" (117 mm) high slip-on rigid spout.
- 5/8" O.D. copper inlet supply tubes.
- 5/8" O.D. corrugated copper supply outlet tubes.
- Control mechanism shall be of the rotating cylinder type with stainless steel plate and 180° rotation, with replaceable non-metallic seats operating in stainless steel lined sockets.
- Hot and cold stems are interchangeable.
- Temperature and volume controlled with handles.
- All operating parts shall be replaceable from the top.
- Conventional rough-in adjusts to 1 1/4" maximum deck thickness.

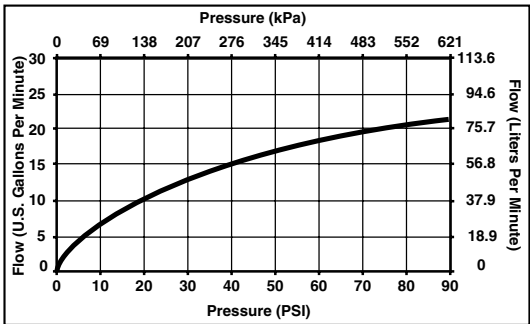

Delta reserves the right (1) to make changes in specifications and materials, and (2) to change or discontinue models, both without notice or obligation. Dimensions are for reference only.

Standard Features	2730	2730-CBLHP	2730-LHP	2730-PB	2730-PBLHP	2730-WHLHP
	Washerless	◆	◆	◆	◆	◆
Three Hole Installation	◆	◆	◆	◆	◆	◆
Flexible Widespread Mount on Deck or Ledge	◆	◆	◆	◆	◆	◆
Conventional Rough-In—Adjusts to 1 1/4" (32 mm) Maximum Deck Thickness	◆	◆	◆	◆	◆	◆
7" (178 mm) Long, 4 5/8" (117 mm) High Slip-On Rigid Spout	◆	◆	◆	◆	◆	◆
Stream Straightener	◆	◆	◆	◆	◆	◆
Clear Knob Handles with Red/Blue Indicators (H61/H61PB)	◆			◆		
Less Handle Program—See Handle Kit Options*		◆	◆		◆	◆
2 5/8" (67 mm) Diameter Decorative Handle Bases	◆	◆	◆	◆	◆	◆
5/8" O.D. Copper Supply Inlet Tubes	◆	◆	◆	◆	◆	◆
5/8" O.D. Corrugated Copper Supply Outlet Tubes	◆	◆	◆	◆	◆	◆
Chrome Finish	◆		◆			
Chrome and <i>Brilliance</i> ® Polished Brass Finish		◆				
<i>Brilliance</i> ® Polished Brass Finish				◆	◆	
White Finish						◆

**Available Options for Field Conversion:**

- NOTE: Standard decorative handle base is 2 5/8" (67 mm) diameter.
- Optional 2 1/2" (64 mm) diameter base with gasket. Cannot be used with RP18235 thick deck rough-in. Order RP18300▲.
- Optional 3" (76 mm) diameter base with gasket. Order RP18543▲.
- Roman Tub hand showers, bath waste assemblies and bath accessories are available separately.



▲ Designate proper finish suffix.

**Installation Aids:**





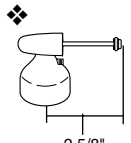

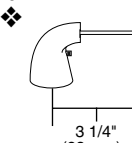
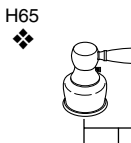
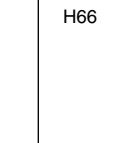
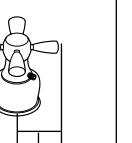
- The Helpful Hand for 4" (102 mm) to 16" (406 mm) centers—aligns widespread handles. Order RP22132.
- Thick tile mounting aid—adds 1" (25 mm) to RP18227 only. Order RP18504 or RP11099 (bulk).
- Thick tile installation aid for RP18227 only. Rigid plastic template installs on deck prior to mud/tile. Order RP27972 or RP28009 (bulk).
- 10" fixed conventional rough-in adjusts to 1 1/4" (32 mm) maximum deck thickness. Order RP23601.
- Thick tile rough-in—mounts to deck prior to mud and tile—adjusts to 3 1/4" (83 mm) maximum deck thickness. Requires RP16867 wrench to adjust. Order RP18235.
- End valve adjustment wrench (for RP18227 and RP18235 rough-in kits). Order RP16867.

**\*Available LHP Handle Options**

❖ For Lever Handles Use 10"-16" Centers.

 H61 1 1/2" (38 mm)	 H62 2 5/8" (67 mm)	 H63 1 1/8" (29 mm)	 H64 3 1/4" (83 mm)
 H65 2 1/2" (64 mm)	 H66 1 7/8" (48 mm)	 H67 1 3/8" (35 mm)	

**\*Available LHP Handle Accent Options**

 A62CL	 A63ST
 A62, A62AB, A62AL, A62PB, A62PR, A62WH	 A64CL
 A62OK	 A64, A64AL, A64PB, A64WH
 A63, A63PB, A63WH	



Indianapolis, Indiana 46280  
 A Division of Masco Corporation of Indiana  
 © 2003 Masco Corporation of Indiana