



Electronic Exposed TECK® II Flush Valves (with H2Optics®)

212385

212385

212385

212385

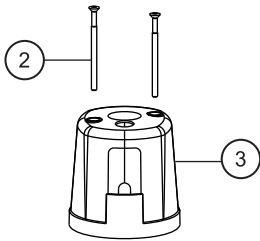

Record model number:

81T2 - **1** - **A** - - -

Valve Type

- 0 = W/C (Water Closet)
- 2 = W/C - 22" outlet tube
- 3 = Urinal

Power Option

- BT = Battery
- HW = Hardwired

Additional Options

- (leave blank if not applicable)
- 30 = w/Sloan®/Zurn® Tail
- 20 = Less Stop Assy
- 1 = V/B Tube w/Tee Assy (W/C only)

Alternate Flush Volumes

- (leave blank if not applicable)
- 6 = 6 L (litre) (1.6 gal) fixed flush (W/C only)
- 13 = 13 L (3.4 gal) flush (W/C Retrofit Kits only)
- 48 = 4.8 L (1.27 gal) fixed flush (W/C only)
- 19 = 1.9 L (0.5 gal) fixed flush (Urinal only)
- 05 = 0.5 L (0.125 gal) fixed flush (Urinal only)

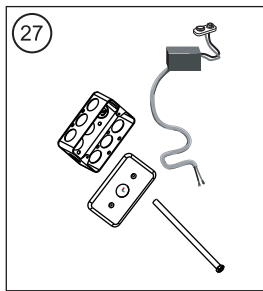
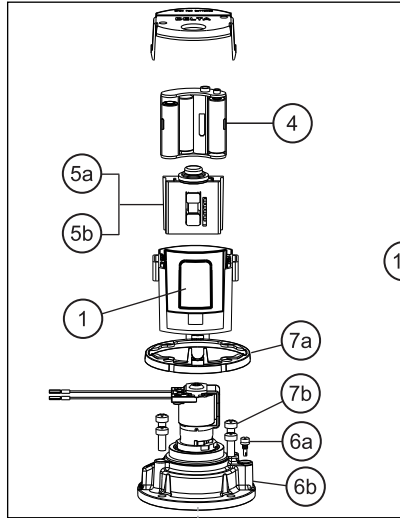

212385

212385

212385

212385

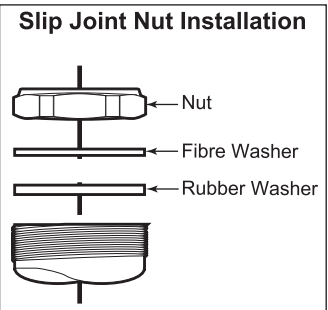
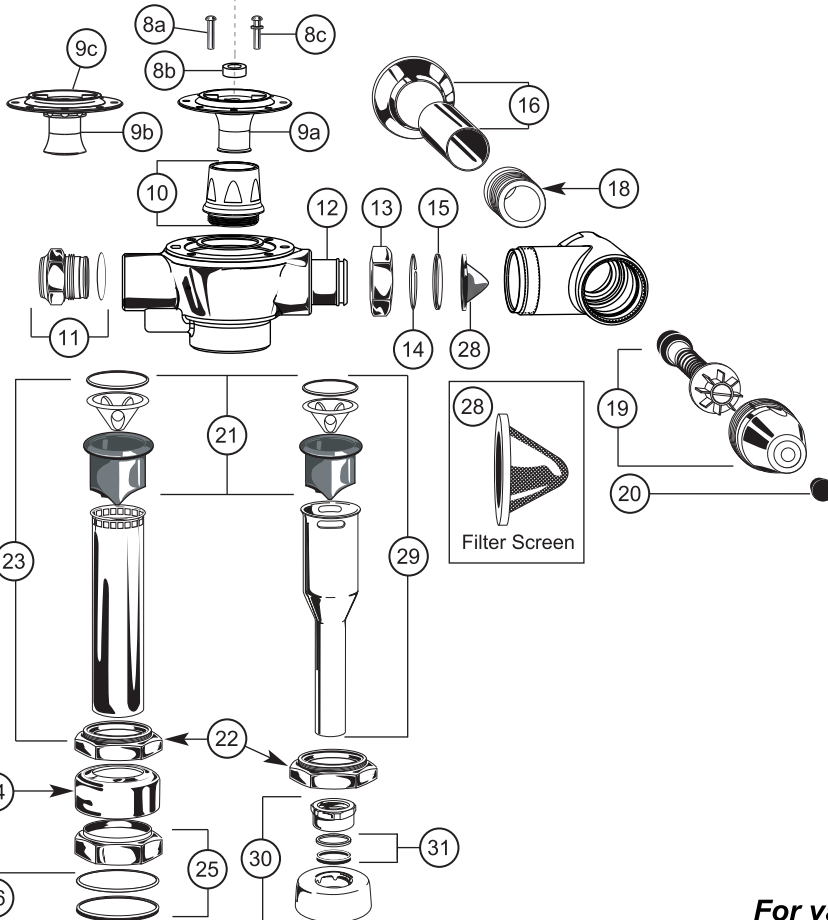

For valves manufactured after January 2013.

PLEASE LEAVE this M&I Sheet with the owner, maintenance plumber, etc. as items relating to ongoing maintenance suggestions and procedures are included.

Item #	Part #	Description
1	061063A	Replaceable Lens for 3rd Generation E-FV
2	061138A *	Cover Screws for 3rd Generation E-FV (2/pkg)
3	061139A	Metal Cover
4	060334A	Battery Holder
5a	061363A	Water Closet Board & Electronic Override Button
5b	061364A	Urinal Board & Electronic Override Button
6a	061024A	Regulating Screw & O-Ring
6b	061341A	Cap/Solenoid & Regulating Screw Assembly for 0.5L (0.125 gal) fixed urinals (see Table 1)
	061342A	Cap/Solenoid & Regulating Screw Assembly for 1.9L (0.5 gal) fixed urinals (see Table 1)
	061344A	Cap/Solenoid & Regulating Screw Assembly for 4.8L (1.27 gal) fixed water closets (see Table 1)
	061345A	Cap/Solenoid & Regulating Screw Assembly for 6.0L (1.6 gal) fixed water closets (see Table 1)
	061352A	Cap/Solenoid & Regulating Screw Assembly for 13.0L (3.4 gal) adjustable water closets (see Table 1)
	061346A	Cap/Solenoid & Regulating Screw Assembly for 1.9L (0.5 gal) adjustable urinals (see Table 1)
6b	061169A	Cap/Solenoid & Regulating Screw Assembly for 6.0L (1.6 gal) adjustable water closets (see Table 1)
7a	061141A *	Cover Gasket (3/pkg)
7b	060078A *	Screws for Cast Cap (4/pkg)
8a	060507A *	Poppet Pin Pack (3/pkg) (see Table 1)
8b	062025A *	Washer (3/pkg) (required for 4.8 & 6.0L Valves only) (see Table 1)
8c	060508A *	Poppet Pin Pack (3/pkg) (0.5L Valves only) (see Table 1)
9a	061323A **	Diaphragm/Guide Assembly Complete - W/C (see Table 1)
9b	061324A **	Diaphragm Guide Assembly for Urinals (See Table 1)
9c	060079A-MMO	Diaphragm only (12/pkg)
10	062007A **	Brass Seat with O-Ring
11	060342A	Plug & O-Ring for Handle End
12	060506A	Standard Adjustable Tail
13	060735A	Union Nut
14	060692A	Retaining Ring
15	060082A *	Adjustable Tail O-Ring Package (20/pkg)
16	060504A	S/S Wall Flange & Cover Tube
17	061142A	Electronic Water Closet Repair Kit for 3rd Generation E-FV
	061143A	Electronic Urinal Repair Kit for 3rd Generation E-FV
18	060697A	1" Copper Sweat Inlet Adaptor
	060694A	¾" Copper Sweat Inlet Adaptor
	060764A	¾" FIP Inlet Adaptor
19	060843A	Retrofit Check Stem Unit, Capnut & Button Complete
	060844A	Seat Washer, Spring, Button & O-Ring Kit
	060859A	Angle Stop with Union Nut & Tail Complete
20	060081A *	Plug Button Package (12/pkg)
21	060785A	Vacuum breaker sleeve complete
22	060094A	Coupling Ring
23	060782A	1-½" x 10" (38 mm x 254 mm) V.B., coupling ring and tube complete
	060783A	1-½" x 22-¾" (38 mm x 578 mm) V.B., coupling ring and tube complete
	060781A	1½" x 10" VB, w/Trap Seal Primer Tee Complete
24	060004A	1½" Spud Flange
25	060778A	1½" Rough Coupling Nut & Washers
26	060083A *	1½" Slip Joint Washers (12/pkg)
27	061069A	Hardwire Converter & Rigid Connection Assembly for 3rd Gen E-FV
28	060344A *	Filter Screen Kit (12/pkg) for Teck tails
29	060784A	¾" x 11½" VB, Ring & Tube Complete (Urinal)
30	060463A	¾" Coupling Nut, ¾" Washers & ¾" Spud Flange
31	060049A *	¾" (19mm) Rubber and fiber washers (12/pkg)
	060704A ***	Transformer (110 to 24 VAC) for 5 sensor modules
	060771A ***	Transformer (110 to 24 VAC) for 10 sensor modules









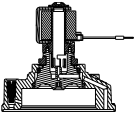

NOTE: Refer to TECK flushometer repair parts and maintenance manual for additional parts and information.

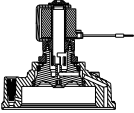
* Package quantities may change. Check the parts section of the latest Delta Commercial Faucet Price List for current quantities.

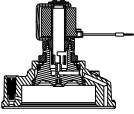
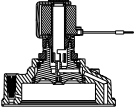
** For valves manufactured before January 2013, you must replace both 061323A / 061324A diaphragm assembly and 062007A brass seat with O-ring. See Table on page 1 to determine appropriate poppet pin & diaphragm repair parts based on the flush volume required.

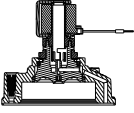
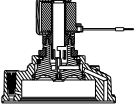
*** Each individual sensor module requires its own 24 VAC to 6 VDC hardwire converter.

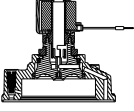
Table 1 - Cap/Pin/Diaphragm Configuration Table

	Flush Volume	Cap/Solenoid & Regulating Screw Assembly (includes Cap, Solenoid, Regulating Screw)	Poppet Pin	Diaphragm Assembly
*UR - Fixed	**0.5L (0.125 gal)	061341A 	060508A 	
	**1.9L (0.5 gal)	061342A 	060507A 	
UR - Adjustable	1.9L (0.5 gal)	061346A 		
W/C - Fixed	**4.8L (1.27 gal)	061344A 	060507A & 062025A 	
	6.0L (1.6 gal)	061345A 		
W/C - Adjustable	***13L (3.4 gal)	061352A 	060507A 	
	6.0L (1.6 gal)	061169A 	060507A & 062025A 	

NOTE: Must use all noted components listed in Table 1 to ensure correct flush volumes.

* Fixed models have epoxy in the adjustment screw.

** WaterSense® compliant when paired with a WaterSense fixture rated for the same flush volume.

*** 13L is only available on the retrofit kits (-20 & -30 models).