

STOP!

If you are unfamiliar with your manufacture date, the label may be located on the Hot inlet tube underneath your sink.

Si no está familiarizado con la fecha de fabricación, es posible que la etiqueta esté ubicada en el tubo de entrada de agua caliente debajo del fregadero.

Si vous n'êtes pas familier avec votre date de fabrication, l'étiquette peut se trouver sur le tube d'arrivée d'eau chaude sous votre évier.

For models produced after 04/10/2022, see page 2 & 3.

For models produced prior to 04/10/2022, see page 4 & 5.

Para los modelos producidos después del 10/04/2022, consulte la página 2 y 3.

Para los modelos fabricados antes del 10/04/2022, consulte la página 4 y 5.

Pour les modèles produits après le 10/04/2022, voir page 2 et 3.

Pour les modèles produits avant le 10/04/2022, voir page 4 et 5.

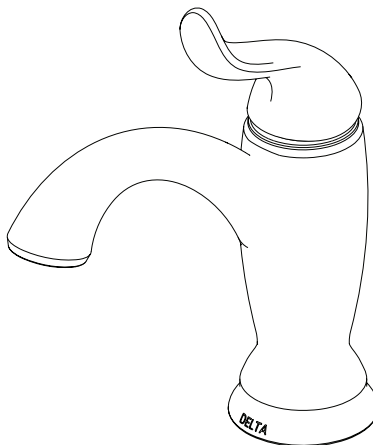

Models/Modelos/Modèles
594-MPU-DST▲ & 794-DST▲
 Series/Series/Seria
Linden™

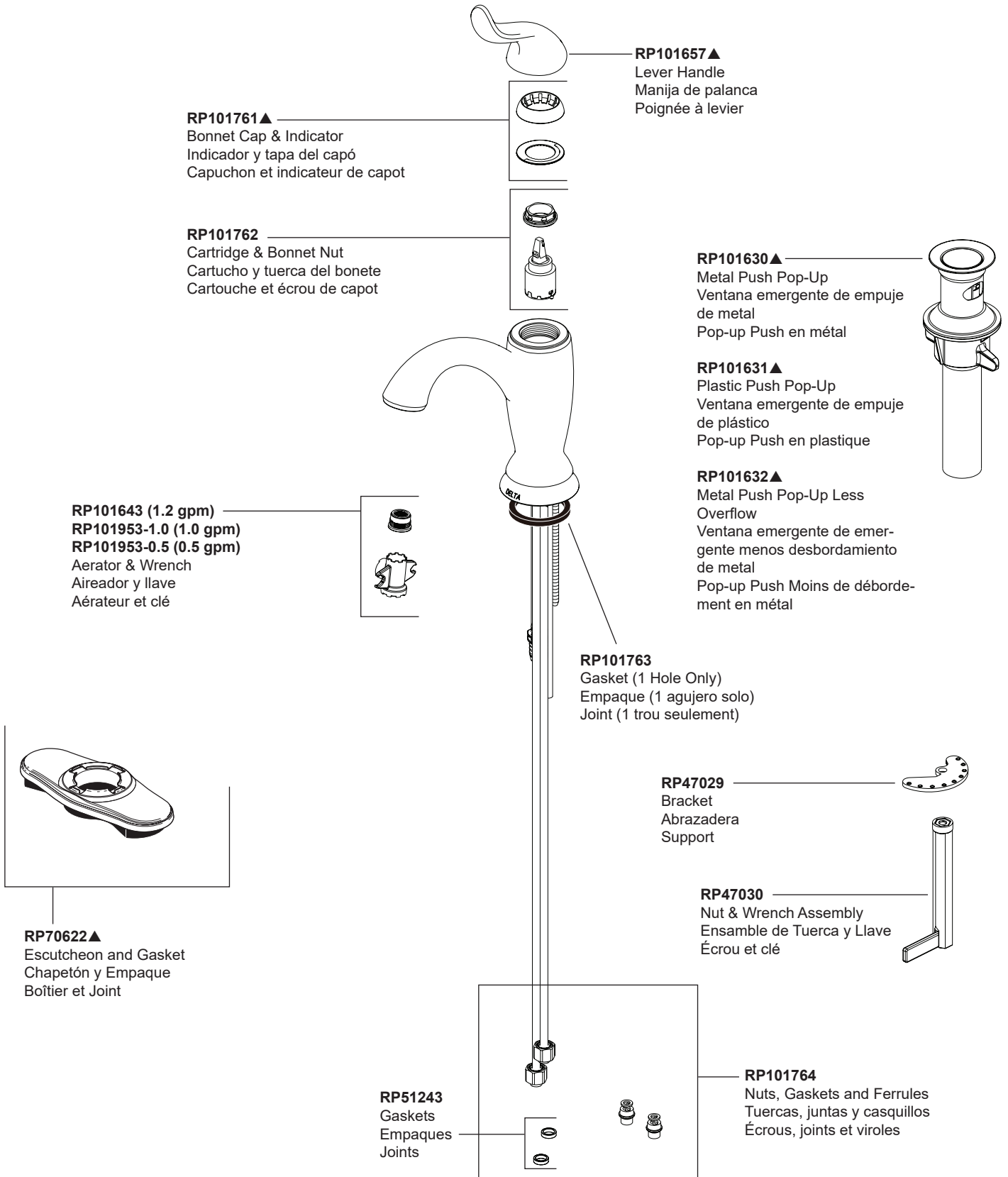

▲Specify Finish / Especificque el Acabado / Précisez le Fini

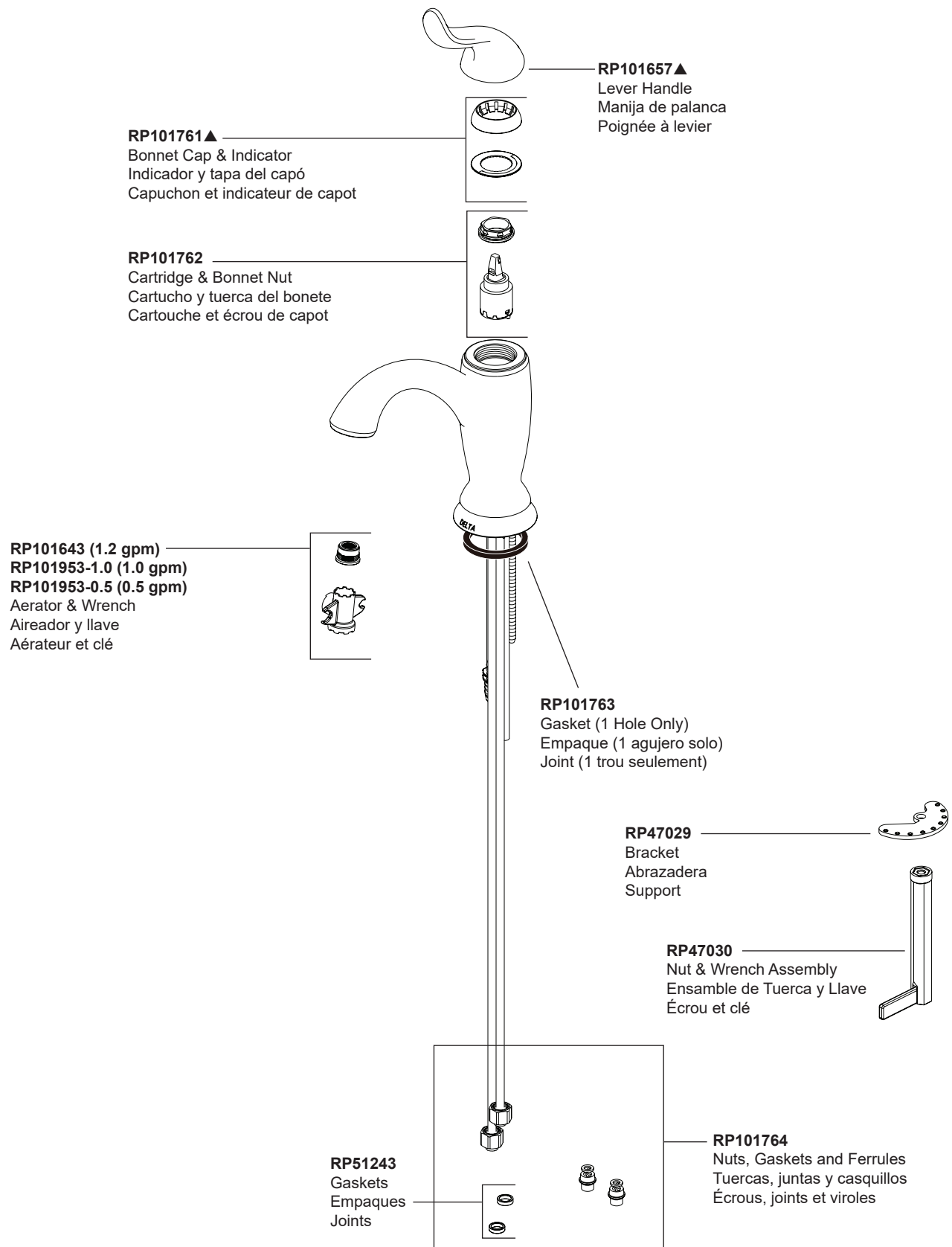

▲Specify Finish / Especificque el Acabado / Précisez le Fini

Models/Modelos/Modèles
594-MPU-DST▲ & 794-DST▲
 Series/Series/Seria
Linden™

RP70622▲
 Escutcheon with
 Gasket (3 Hole)
 Chapetón y
 Empaque (3 agujeros)
 Boîtier et Joint (3 trous)

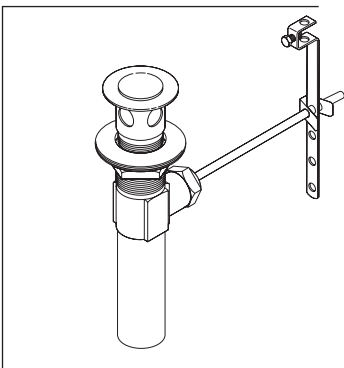
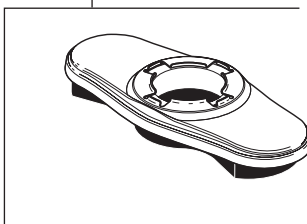

RP26533▲
 Metal Pop-Up Assembly Less Lift Rod
 Ensamble de Metal del Desagüe
 Automático Sin la Barra de Alzar
 Renvoi Mécanique en Métal Sans
 la Tige de Manoeuvre

RP63263
 Adapters
 3/8"-24 UNEF to 1/2"-20 UN &
 3/8"-24 UNEF to 1/2"-14 NPSM
 Adaptadors
 3/8"-24 UNEF a 1/2"-20 UN &
 3/8"-24 UNEF a 1/2"-14 NPSM
 Adapteurs
 3/8 po-24 UNEF à 1/2 po-20 UN et
 3/8 po-24 UNEF à 1/2 po-14 NPSM

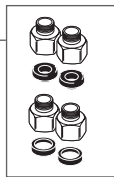

RP63264
 Adapters (10) 3/8"-24 UNEF to 1/2"-20 UN
 Adaptadors (10) 3/8"-24 UNEF a 1/2"-20 UN
 Adapteurs (10) 3/8 po-24 UNEF à 1/2 po-20 UN

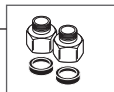

RP63265
 Adapters (10) 3/8"-24 UNEF to 1/2"-14 NPSM
 Adaptadors (10) 3/8"-24 UNEF a 1/2"-14 NPSM
 Adapteurs (10) 3/8 po-24 UNEF à 1/2 po-14 NPSM



RP70623▲
 Handle, Red/Blue Button
 & Set Screw
 Manija, Botón Rojo/Azul
 y Tornillo de Ajuste
 Manette, Bouton Rouge/
 Bleu et Vis de Calage

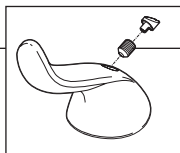

RP37036
 Set Screw
 Tornillo de Ajuste
 Vis de calage

RP54975
 O-Ring
 Anillo O
 Joint torique



RP54972▲
 Cap
 Casquillo
 Embase



RP54976
 Bonnet
 Bonete
 Chapeau

RP50587
 Valve Assembly
 Ensamble de la válvula
 Soupape



RP52216
RP52216-1.2
 Aerator
 Aereador
 Aérateur



RP52217
 Wrench
 Llave
 Clé

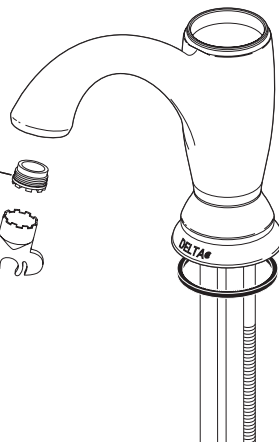

RP47029
 Bracket
 Abrazadera
 Support

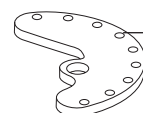

RP47030
 Nut & Wrench Assembly
 Ensamble de Tuerca y Llave
 Écrou et clé

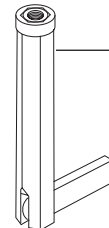

RP50952
 Plastic Sleeves
 Mangas Plásticas
 Manchons en plastique



RP51243
 Gaskets
 Empaques
 Joints



▲ Specify Finish / Especificíque el Acabado / Précisez le Fini

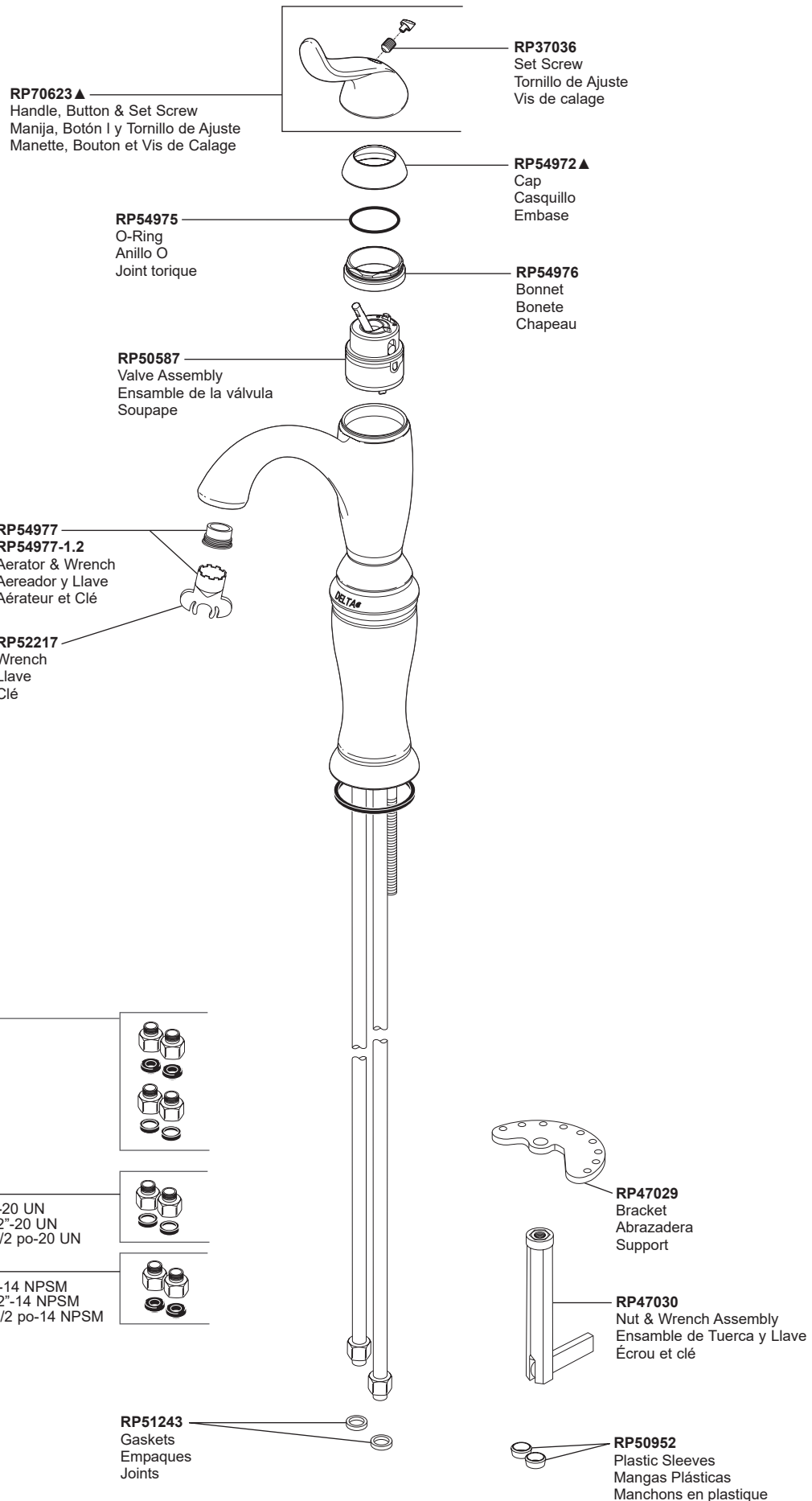

▲Specify Finish / Especificue el Acabado / Précisez le Fini