

RP100523▲
Sprayer & Hose Assembly
Ensamblaje de pulverizador y manguera
Douchette et tuyau souple

RP50815
Aerator & Wrench
Aereador y Llave
Aérateur et Clé

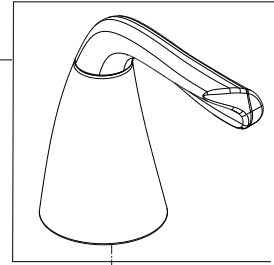

RP103959▲
Handle Assemblies
Conjunto de manija
Montage de la manette

RP101504
Stem Unit Assembly, Seat & Spring,
Bonnet Nut
Ensamble de la Unidad del Vástago,
Asiento, Resorte y Bonete
Obturateur, siège et ressort et écrou à
chapeau

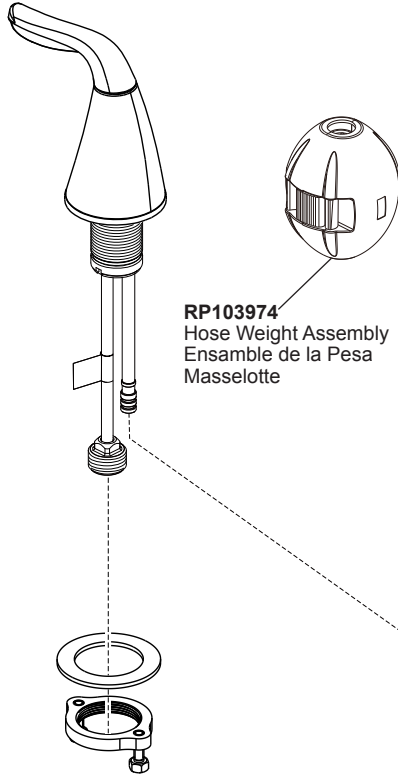

RP103974
Hose Weight Assembly
Ensamble de la Pesa
Masselotte

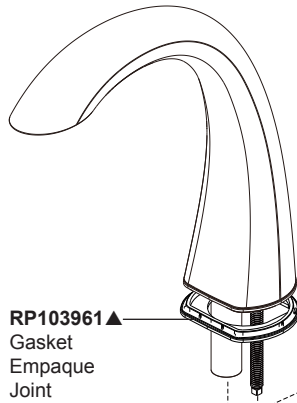

RP103961▲
Gasket
Empaque
Joint

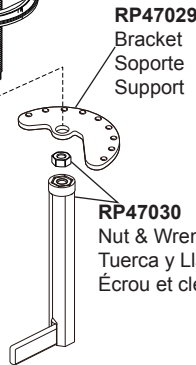

RP47029
Bracket
Soporte
Support

RP47030
Nut & Wrench
Tuerca y Llave
Écrou et clé

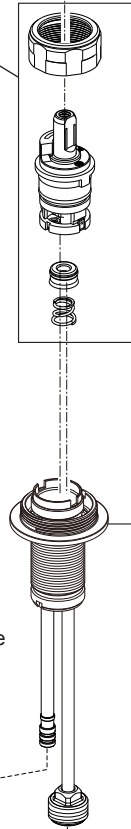

RP103960
Gasket Base Plate &
O-ring
Placa base de junta y
Anillo "O"
Plaque de base du joint
et joints torique

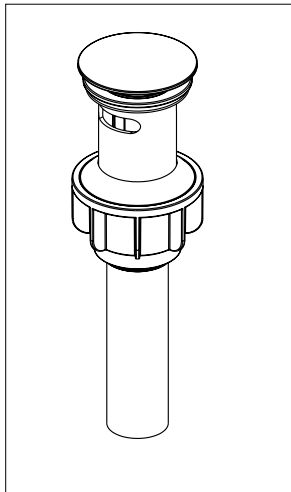

RP100137▲
Push Pop-UP with Overflow
Control de rebose para
desagües manuales
Mécanique à poussoir avec trop-plein

RP103819
Y Connector and
Check Valve
Conexión "Y" con
Válvulas Checadoras
Raccord en Y avec
Clapets de non-retour

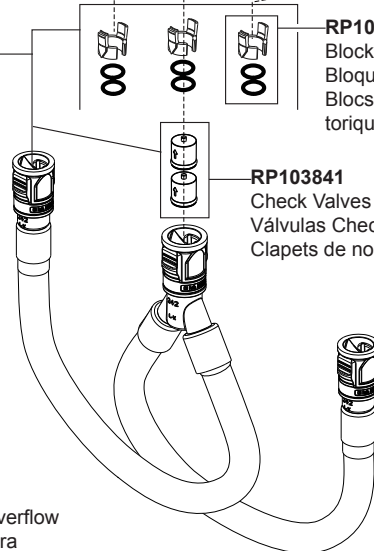

RP103672
Block & O-Rings
Bloque y Anillos "O"
Blocs de fixation et joints
toriques

RP103841
Check Valves
Válvulas Checadoras
Clapets de non-retour

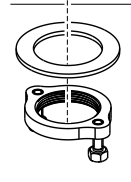

RP101297
Washers (2), Nuts (2)
& Screws (4)
Arandelas (2), Tuercas (2)
y Tornillos (4)
Rondelles (2), Écrous(2)
et Vis (4)

▲ Specify Finish
Especifique el Acabado
Précisez le Fini