



COMPLIES WITH:

- ASME A112.18.1/CSA B125.1
- ICC/ANSI A117.1
- Verified compliant with 0.25% weighted average Pb content regulations

WARRANTY:

- 5 year limited warranty on parts (other than batteries) and finishes of this Delta® commercial product from the date of purchase. No warranty is provided on batteries.
- Please see the warranty for all terms, conditions and limitations. Copies of the warranty are available from DeltaCommercialFaucets.com.

MODEL: 830DPA58TR-CZ

SERIES: 830DPA FAUCET

Electronic Hardwire Operated Deckmount Faucet TRIM

FEATURES:

- Proximity® Sensing Technology
- Champagne Bronze® (CZ) Finish
- Vandal Resistant Laminar, Aerated, and Mikado Spray Outlets included at 0.5 gpm (1.9 L/min) flow rate
- Designed for routine 180°F (82°C) disinfection cycles up to 30 mins

SPECIFICATIONS:

- Electronic hardwire operated deckmount faucet
- Adjustable sensing range and timeout
- Solenoid and Controller included
- Serviceable filter screen upstream of the solenoid valve
- Single tempered water supply
- ELAVT0001ARI or ELAVT0008ARI rough-in required (order separately)
- Mixing valve required for models used with ELAVT0001ARI (order separately)
- AC Filter and Transformer required
- 063267A – AC Filter & Transformer for up to 5 valves (order separately)
- Optional 4" Cover plate - 061269CZ (order separately)

OPERATION:

- Hands free (touchless) operation
- No visible sensor, the spout is the sensor
- Adjustable sensing distance factory set to 3" (76 mm)
- Adjustable auto shut off feature. Factory set to 45 seconds
- Periodic rinse feature, time adjustable in 6 hour increments up to 2 days. Selectable rinsing lengths from 10 to 180 seconds. Factory set off.
- Metering mode with selectable flow times of 7 seconds to 4 minutes, factory set off.



Delta reserves the right (1) to make changes to specifications and materials, and (2) to change or discontinue models, both without notice or obligation. Dimensions are for reference. Measurement may vary plus or minus 6mm(0.25"). Mounting locations are suggested only. Check with local codes for requirements in your area.

DELTA FAUCET COMPANY 55 East 111th St. Indianapolis, IN, USA 46280 - 317.848.1812
MASCO CANADA LIMITED 350 South Edgeware Rd, St. Thomas, ON, Canada N5P 4L1 - 905.712.3030

MODEL: 830DPA58TR-CZ

REQUIRED ACCESSORIES:

- [AC Filter & Transformer](#)

OPTIONAL ACCESSORIES:

- [4" Cover Plate](#)
- [36" Sensor Extension Cable](#)
- [Battery Back-up](#)
- [AC Filter](#)
- [Transformer \(20 VA\)](#)
- [Transformer \(40 VA\)](#)

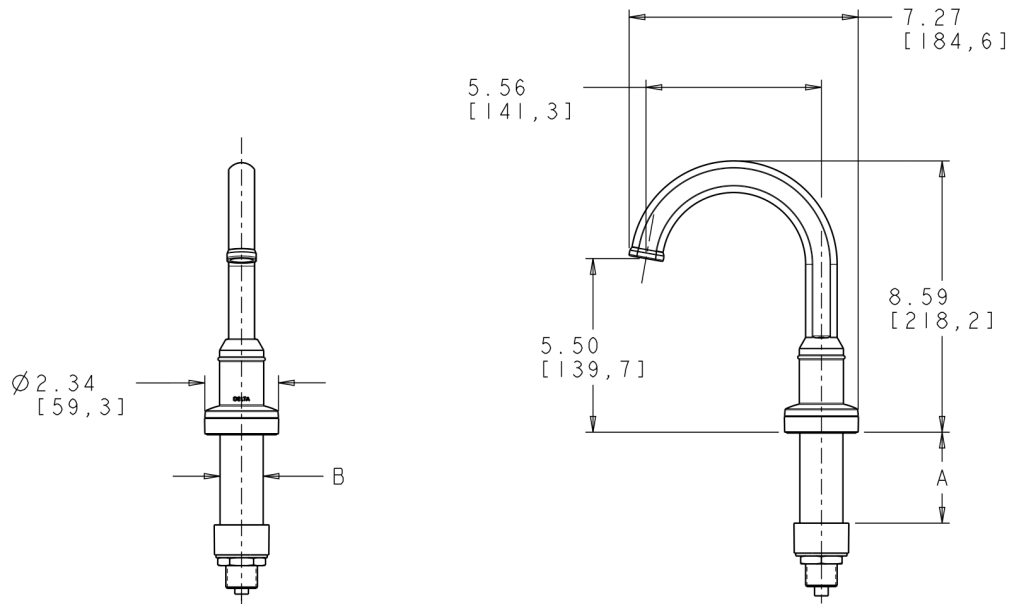

Dimension Units: INCH[MM]
 Measurements may vary ± 0.25 " [6 mm]

A - 2.5" [64 mm] Maximum Deck Thickness

B - 1.25" [32 mm] Hole Diameter

Notes:

HELPFUL LINKS: