



see what Delta can do™

KITCHEN SINKS

- Wallis® Collection
- Top Mount Farmhouse

FEATURES:

- Top Mount Apron Front Single Bowl Sink
- Rear Center Set Drain
- NoiseDefend Undercoating and Sound Dampening Pads

STANDARD SPECIFICATIONS:

- 16 Gauge Stainless Steel Construction
- Required Minimum Cabinet Size: 39" Left to Right, 24" Front to Back
- 3 7/8" Drain Opening
- Strainer ADU25-SS (included)
- Bottom Grid AFU34-AT36-DG (included)
- Rolling Mat ACU25-SRMC-DG (included)
- Cut-Out Template (included)
- Top Mount Hardware (included)

WARRANTY:

- Lifetime Limited Warranty

COMPLIES WITH:

- cUPC (ASME A112.19.3/CSA B45.4)

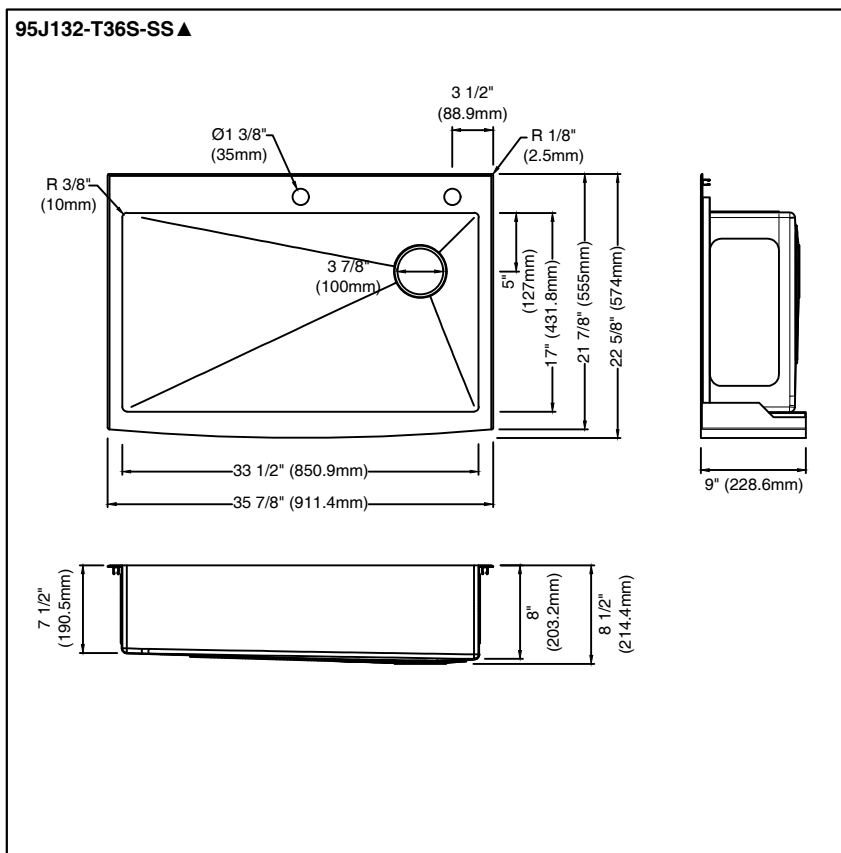
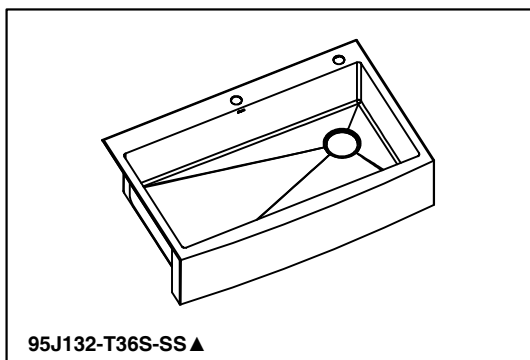

▲ Designate proper finish suffix

Delta reserves the right (1) to make changes in specifications and materials, and (2) to change or discontinue models, both without notice or obligation. Dimensions are for reference only. See current full-line price book or www.deltafaucet.com for finish options and product availability.

Delta Faucet Company

55 E. 111th Street, Indianapolis, IN 46280
350 South Edgeware Road, St. Thomas, ON N5P 4L1
Sinksupport@deltafaucet.com
© 2021 Delta Faucet Company



see what Delta can do™

KITCHEN ACCESSORY

- Kitchen Roll-Up Dish Drying Rack

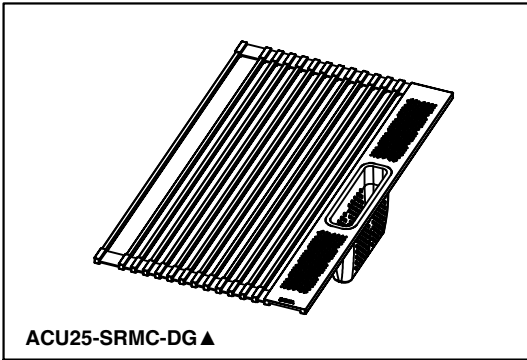

ACU25-SRMC-DG ▲

Submitted Model No.: _____

Specific Features: _____

FEATURES:

- Roll-up over-the-sink drying rack
- Stainless steel construction with non-slip silicone coating
- Rolls up for storage
- Dishwasher safe
- Heat-safe up to 400° F
- Included with the 95J132-T30S-SS, 95J132-T33S-SS and 95J132-T36S-SS Kitchen Sinks

STANDARD SPECIFICATIONS:

- Product Height: 1/4"
- Product Length: 16 7/8"
- Product Width: 12"

WARRANTY:

- 1 Year Limited Warranty

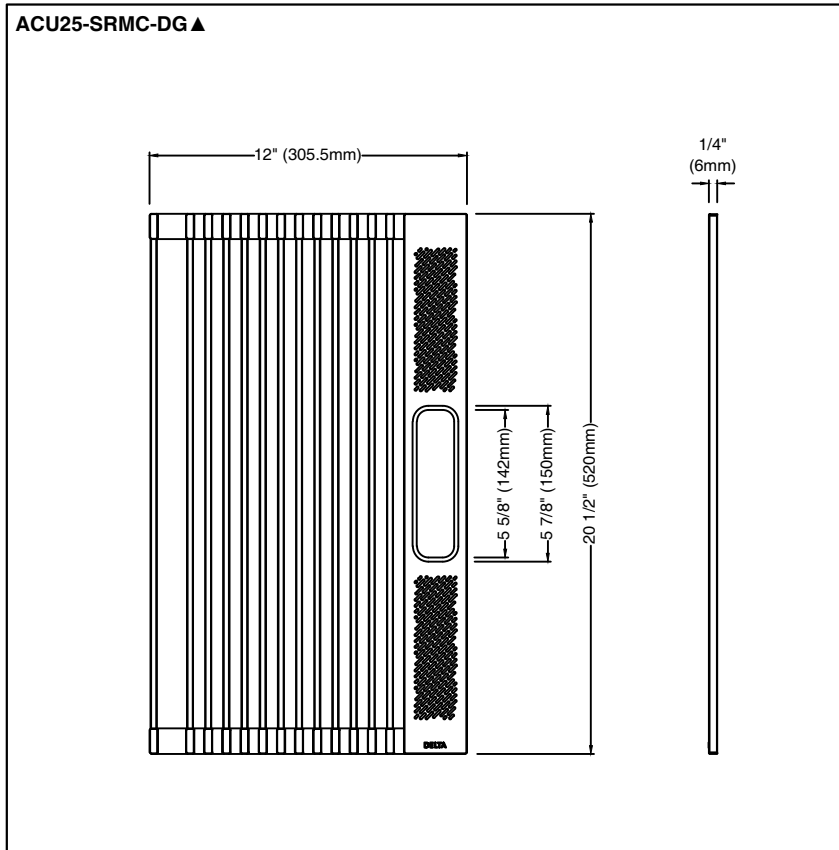

▲ Designate proper finish suffix

Delta reserves the right (1) to make changes in specifications and materials, and (2) to change or discontinue models, both without notice or obligation. Dimensions are for reference only. See current full-line price book or www.deltafaucet.com for finish options and product availability.

Delta Faucet Company

55 E. 111th Street, Indianapolis, IN 46280
350 South Edgeware Road, St. Thomas, ON N5P 4L1
Sinksupport@deltafaucet.com
© 2021 Delta Faucet Company



see what Delta can do™

KITCHEN ACCESSORY

■ Kitchen Strainer

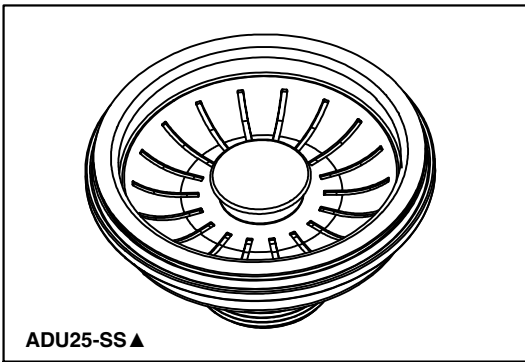

ADU25-SS ▲

Submitted Model No.: _____

Specific Features: _____

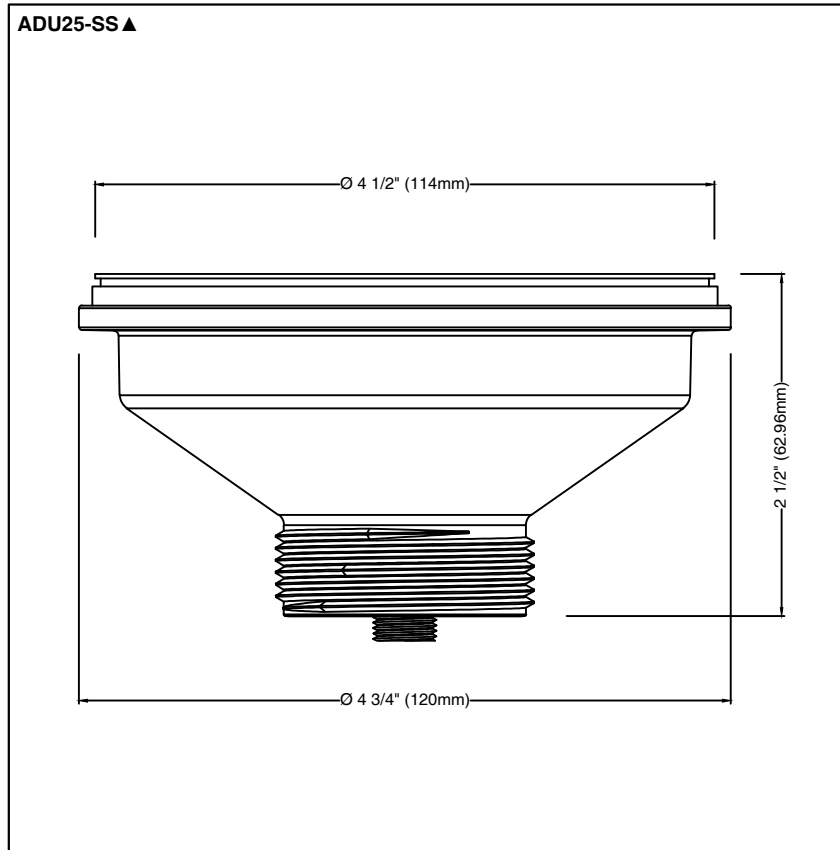

FEATURES:

- Strainer traps food particles and debris to keep drain clear
- Maximizes your sinks functionality and complements the look of your kitchen
- The open/close stopper creates a tight seal that prevents food and debris from clogging the drainpipe
- Durable Stainless Steel Construction
- Compatible with 95A931-25S-SS, 95A931-30S-SS, 95A931-33D-SS, 95A931-33S-SS, 95A932-25S-SS, 95A932-30S-SS, 95A932-33S-SS, 95B931-27S-SS, 95B931-30S-SS, 95B931-32S-SS, 95B931-33D-SS, 95B932-27S-SS, 95B932-30S-SS and 95B932-32S-SS kitchen sinks

STANDARD SPECIFICATIONS:

- Stainless Steel Construction
- Product Height: 2 1/2"
- Product Length: 4 1/2"
- Product Width: 4 1/2"

WARRANTY:

- 1 Year Limited Warranty

▲ Designate proper finish suffix

Delta reserves the right (1) to make changes in specifications and materials, and (2) to change or discontinue models, both without notice or obligation. Dimensions are for reference only. See current full-line price book or www.deltafaucet.com for finish options and product availability.

Delta Faucet Company

55 E. 111th Street, Indianapolis, IN 46280
350 South Edgeware Road, St. Thomas, ON N5P 4L1
Sinksupport@deltafaucet.com
© 2021 Delta Faucet Company



see what Delta can do™

KITCHEN ACCESSORY

- Kitchen Sink Grid

FEATURES:

- For use with the 95J132-T36S-SS kitchen sink
- Protects bottom of the sink from daily wear and tear
- Silicone feet provide additional protection

STANDARD SPECIFICATIONS:

- Silicone Construction
- Product Height: 1/2"
- Product Length: 33 1/4"
- Product Width: 16 3/4"

WARRANTY:

- 1 Year Limited Warranty

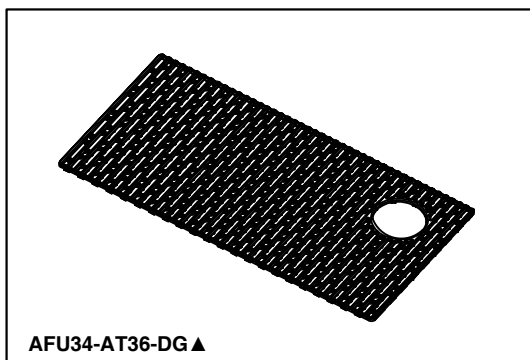

AFU34-AT36-DG ▲

Submitted Model No.: _____

Specific Features: _____

AFU34-AT36-DG ▲

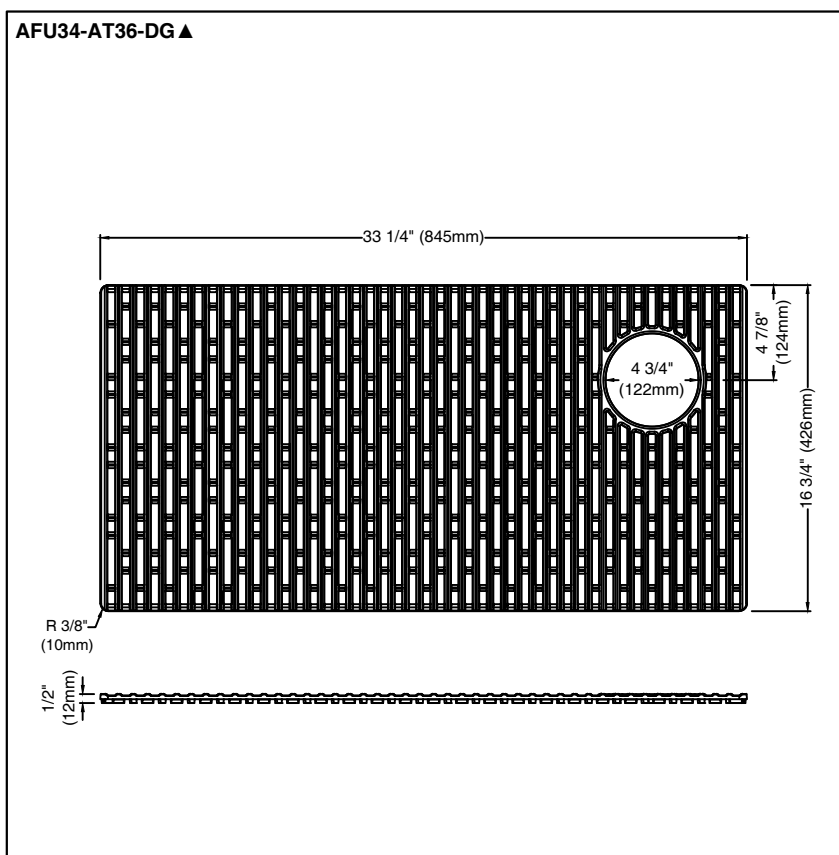

▲ Designate proper finish suffix

Delta reserves the right (1) to make changes in specifications and materials, and (2) to change or discontinue models, both without notice or obligation. Dimensions are for reference only. See current full-line price book or www.deltafaucet.com for finish options and product availability.

Delta Faucet Company

55 E. 111th Street, Indianapolis, IN 46280
350 South Edgeware Road, St. Thomas, ON N5P 4L1
© 2021 Delta Faucet Company