



Lavatory Faucets

4" deck LESS pop-up - CER-TECK® ceramic structures

Model No: 27C4353

COMPLIES WITH:

- Verified compliant with 0.25% weighted average Pb content regulations
- CSA certified.
- Complies to ASME A112.18.1/CSA B125.1
- (Contact Delta Representative for State and/or Local Approvals)



NOTES:

27T4 - 4" deck LESS pop-up -TUF-TECK® compression structures

SPECIFICATION:

- HEAVY DUTY CAST BRASS sink faucet
- 102mm (4") centers, two handle
- Polished chrome plated finish
- CER-TECK® ceramic structures
- Metal hold-down package
- Spout#: 3 - 152mm (6") Tubular Swing Spout(S3)
- Outlet#: 5 - Vandal Resistant 0.5gpm (1.9 L/min) Non-Aerating Spray Outlet
- Handle#: 3 - 76 mm (3") Lever Blade Handles-ADA Compliant-Metal-Color indexed-Vandal Resistant screws

OPERATION:

- Not Available

(Dimensional drawing on following page)

Delta reserves the right (1) to make changes to specifications and materials, and (2) to change or discontinue models, both without notice or obligation. Dimensions are for reference. Measurement may vary plus or minus 6mm(0.25"). Mounting locations are suggested only. Check with local codes for requirements in your area. This spec was produced July 13, 2021.

Delta Faucet Company - 55 East 111th St. - Indianapolis, Indiana, USA 46280 - (317) 848-1812
Delta Faucet Canada - 395 Matheson Blvd E - Mississauga, Ontario, Canada L4Z 2H2 - (905) 712-3030

Model No: 27C4353

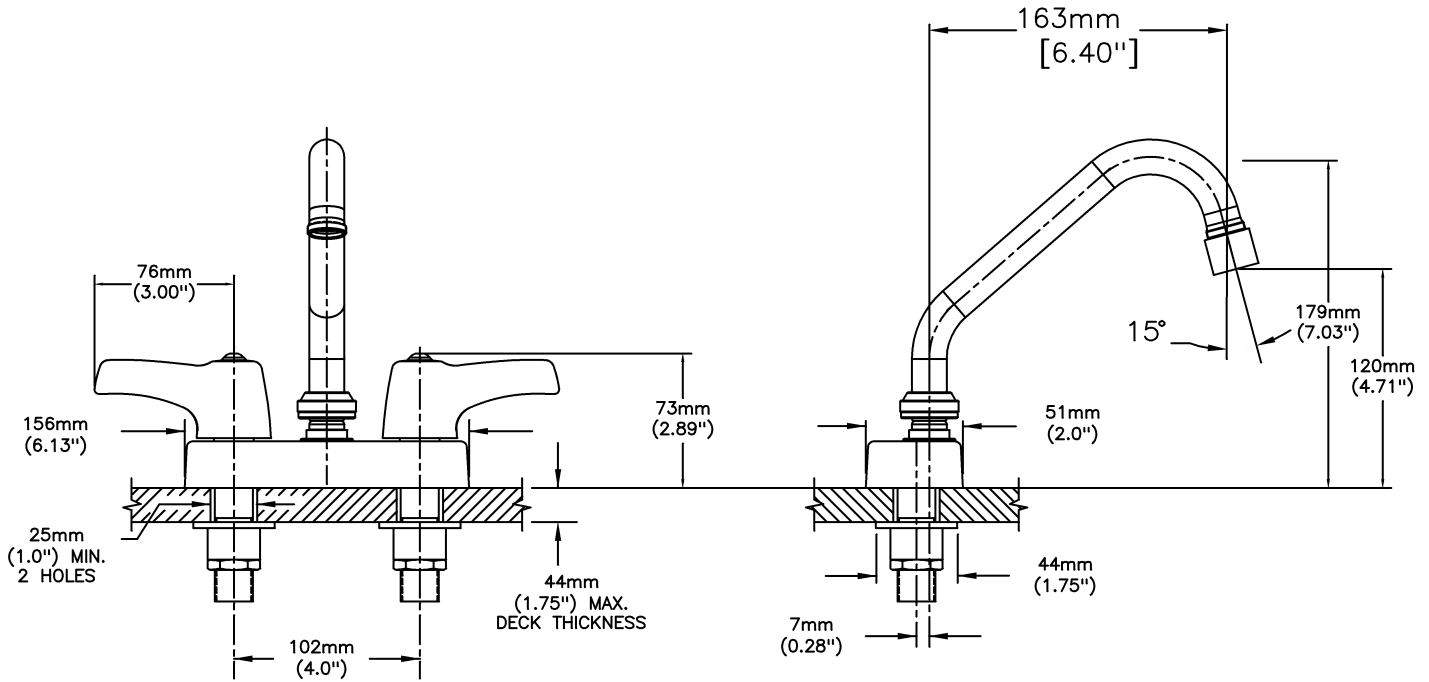

INLET FOR 3/8" OR 1/2" FLEXIBLE RISER
OR 1/2-14 NPSM COUPLING NUT (NOT SUPPLIED)

Delta reserves the right (1) to make changes to specifications and materials, and (2) to change or discontinue models, both without notice or obligation. Dimensions are for reference. Measurement may vary plus or minus 6mm(0.25"). Mounting locations are suggested only. Check with local codes for requirements in your area. This spec was produced July 13, 2021.

Delta Faucet Company - 55 East 111th St. - Indianapolis, Indiana, USA 46280 - (317) 848-1812
Delta Faucet Canada - 395 Matheson Blvd E - Mississauga, Ontario, Canada L4Z 2H2 - (905) 712-3030