

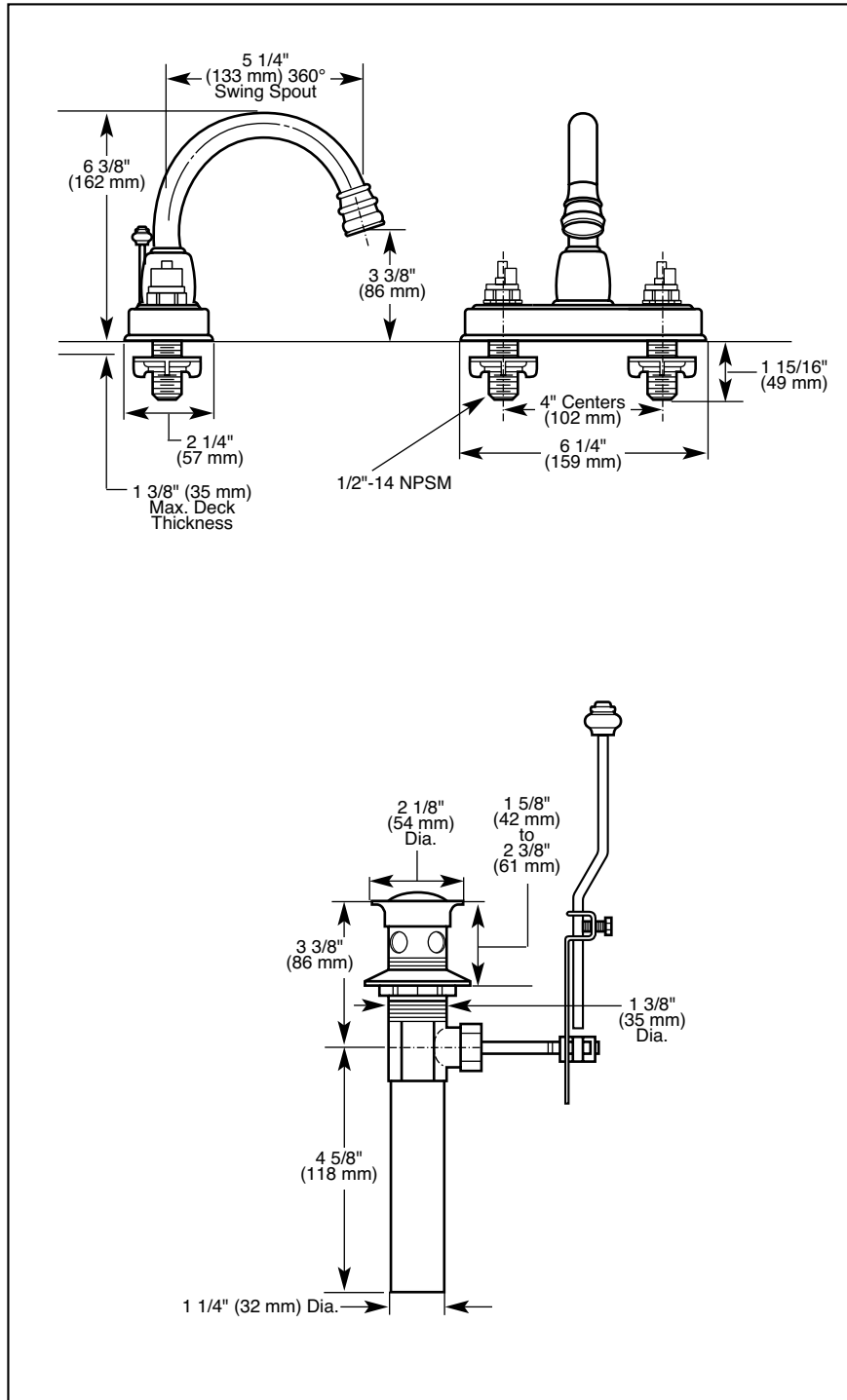

Submitted Model No.: _____

Specific Features: _____



DELTA[®]

LAVATORY FAUCETS

- Two Handle
- NEO STYLE[®] Series
- LHP-Less Handle Program
- 3 Hole Sink Applications
- 4" Centerset



LISTED
UL Listed to US and Canadian
Safety Standards and Classified
in accordance with
ANSI/NSF 61-97b
21PL



COMPLIES WITH:

- ASME A112.18.1M-1996
- CSA B125-93
- Indicates ADA compliance to CABO/ANSI A117.1-1992
- IAPMO Listed
- CSA Certified

STANDARD SPECIFICATIONS:



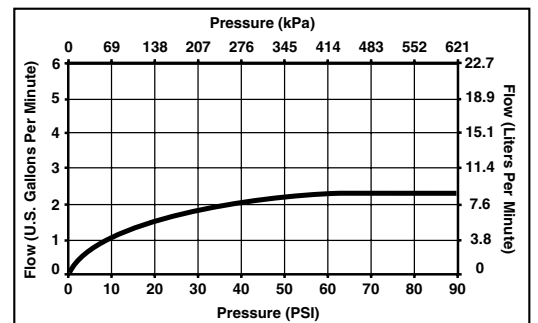

- Two handle lavatory deck faucets for exposed mounting on three hole sinks.
- 4" (102 mm) centerset.
- Solid brass fabricated body.
- 5 1/4" (133 mm) long, 6 3/8" (162 mm) high spout swings 360°.
- LHP-Less Handle Program. See handle kit options on back.
- Hot and cold stems are interchangeable.
- Control mechanism shall be of the rotating cylinder type with stainless steel plate and 180° rotation, with replaceable non-metallic seats operating in stainless steel lined sockets.
- 1/2"-14 NPSM threaded male inlet shanks.
- Models have metal drain with pop-up type fitting with plated flange and stopper.





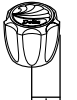
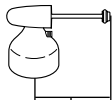
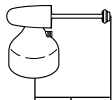

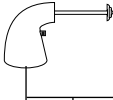
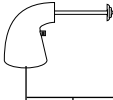
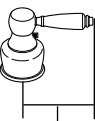
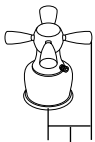
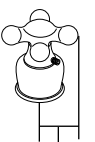













Delta reserves the right (1) to make changes in specifications and materials, and (2) to change or discontinue models, both without notice or obligation. Dimensions are for reference only.

Standard Features	2567-LHP	2567-CBLHP	2567-PBLHP	2567-WCLHP	2567-WPLHP
Washerless	◆	◆	◆	◆	◆
Three Hole Installation	◆	◆	◆	◆	◆
4" (102 mm) Centerset	◆	◆	◆	◆	◆
5 1/4" (133 mm) Long, 6 3/8" (162 mm) High Spout Swings 360°	◆	◆	◆	◆	◆
Less Handle Program See Handle Kit Options*	◆	◆	◆	◆	◆
1/2"-14 NPSM Threaded Male Inlet Shanks	◆	◆	◆	◆	◆
Metal Pop-Up Drain	◆	◆	◆	◆	◆
Chrome Finish	◆				
Chrome and <i>Brilliance</i> ™ Polished Brass Finish		◆			
<i>Brilliance</i> ™ Polished Brass Finish			◆		
White and Chrome Finish				◆	
White and <i>Brilliance</i> ™ Polished Brass Finish					◆

***Available LHP Handle Options**

H21  1" (25 mm)	H22  2 1/2" (64 mm)	A22  2 1/2" (64 mm)	H23  1" (25 mm)	A23  1" (25 mm)	H24  3 1/4" (83 mm)	A24  3 1/4" (83 mm)
H25  2 1/2" (64 mm)	H26  1 1/4" (32 mm)	H27  1 1/4" (32 mm)	H28  1 7/16" (37 mm)			

***Available LHP Handle Accent Options with Matching Lift Knobs**

 A22CL		 A24CL	
 A22, A22AL, A22PB, A22WH		 A24, A24AL, A24PB, A24WH	
 A22PR		 A23ST	
 A22OK, A22RS, A22WW		 A23OK	
 A23, A23AL, A23PB, A23WH			



Indianapolis, Indiana 46280
A Division of Masco Corporation of Indiana
© 2001 Masco Corporation of Indiana