

INSTALLATION INSTRUCTIONS FOR LEVERSET

BEFORE PROCEEDING:

1. Make sure backset of lock is same as backset of your door. If not, adjust the backset to fit your door as shown in step 1.
2. Please read this instructions completely before attempting to install lock.

TOOLS REQUIRED:

1. Electric drill
2. 2" and 1" drill bits
3. Screwdriver
4. 1" chisel
5. Soft faced hammer

1. ADJUSTABLE LATCH FOR 2-3/8" (60mm) AND 2-3/4" (70mm) BACKSET

Some models are supplied with adjustable latch which can fit 2-3/8" or 2-3/4" (60mm or 70mm) backset. Adjustable latch was preset at factory for a 2-3/4" (70mm) backset. If a 2-3/8" (60mm) backset is required, please adjust as shown below.

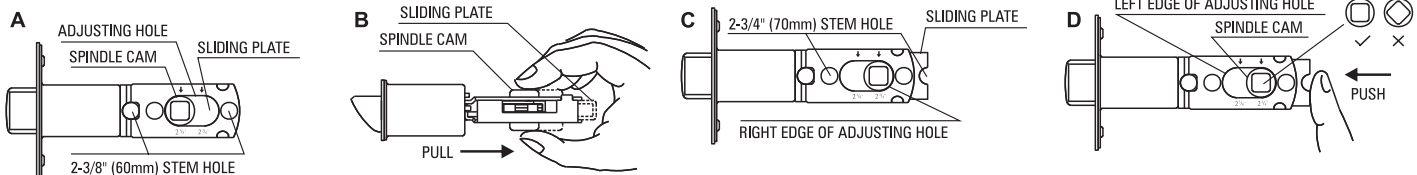

- This latch is for 2-3/8" (60mm) backset.
- Pull spindle cam all the way to right edge of adjusting hole.
- Be sure the 2-3/4" (70mm) stem hole is properly aligned.
- Your latch is now set for a 2-3/4" (70mm) backset.
- To re-set 2-3/8" (60mm) backset just push spindle cam to left edge of adjusting hole.

Note : Be sure to keep spindle cam square in correct position as illustrated before pushing spindle cam to left. Otherwise you will have difficulty in pushing spindle cam to left.

2. DETERMINE HANDING OF YOUR DOOR

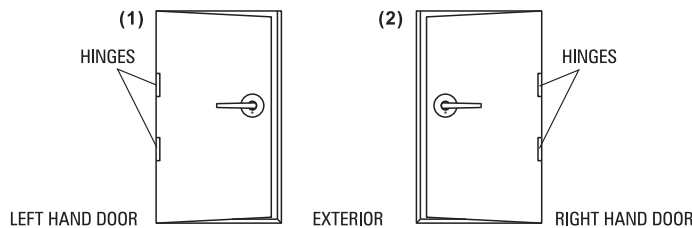

- Stand at exterior side and face to your door.
- (1) Your door is left hand door if hinges were installed at your left hand.
 - (2) Your door is right hand door if hinges were installed at your right hand.

3. MARK DOOR

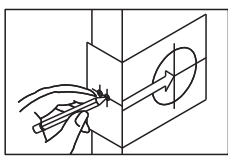

- Start 36" (914mm) from floor, fold and apply template on door edge and mark center of door edge.
- Select 2-3/8" or 2-3/4" (60mm or 70mm) backset as desired and mark center of hole on door face.

NOTE: Backset on door face must be same as backset of your lock.

4. DRILL HOLES

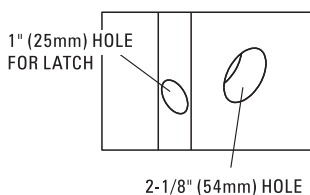

Drill holes as marked.
NOTE: Drill 2" (51mm) or 2-1/8" (54mm) hole from both side of door to avoid splitting wood.

5. INSTALL LATCH

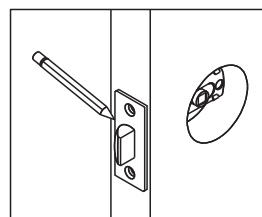

- Insert latch in hole and keep it parallel to door face. Mark outline of face plate and remove latch.

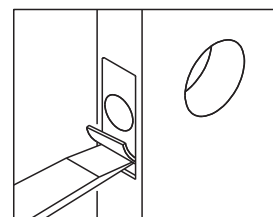

- Chisel 1/8" (3mm) deep or until face plate flush with door edge.

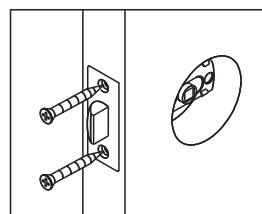

- Insert latch and tighten screws.

6. INSTALL STRIKE

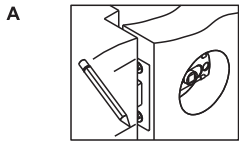

Close door until latchbolt touches jamb to locate strike in jamb and center line of strike. Open door and extend line from mark to door stop. Measure one half of door thickness from door stop and vertically mark drill point center for strike.

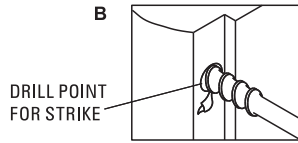

Drill 1" (25.4mm) hole 1/2" (13mm) deep in door jamb on drill point for strike.
CAUTION: To assure proper lockset function hole in jamb must be drilled a full 1/2" (13mm) deep.

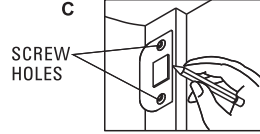

Match screw holes on strike with center line on jamb. Outline outside edge of strike. Chisel 1/16" (1.6mm) deep for strike.

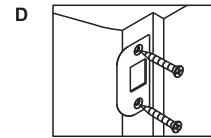

Adjustable tang on strike permits bending in or out to eliminate too loose fit between door and door stop.

INSTALL STRIKE AND TIGHTEN SCREWS.

7. INSTALL LEVER - PRIVACY

INSTALL PRIVACY LEVERSET

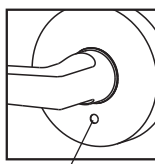

EMERGENCY UNLOCKING HOLE

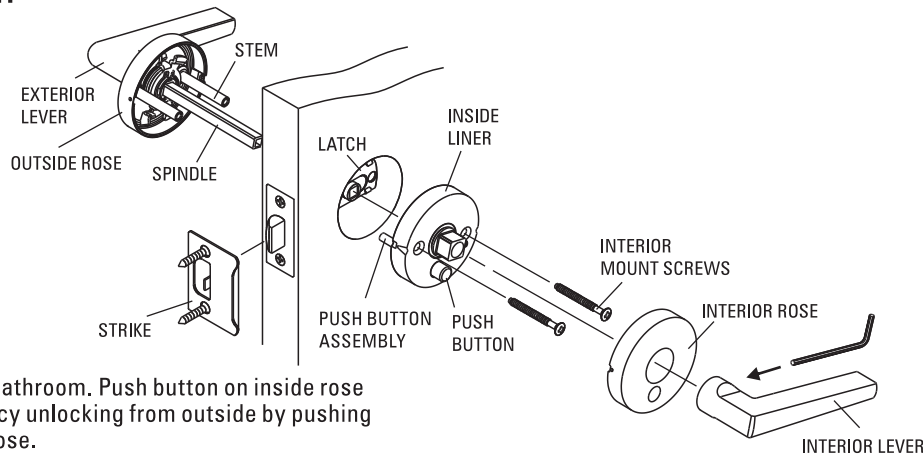

Privacy lever set is for bed / bathroom. Push button on inside rose to lock both levers. Emergency unlocking from outside by pushing button thru hole on outside rose.

8. INSTALL LEVER - PASSAGE

INSTALL PASSAGE LEVERSET

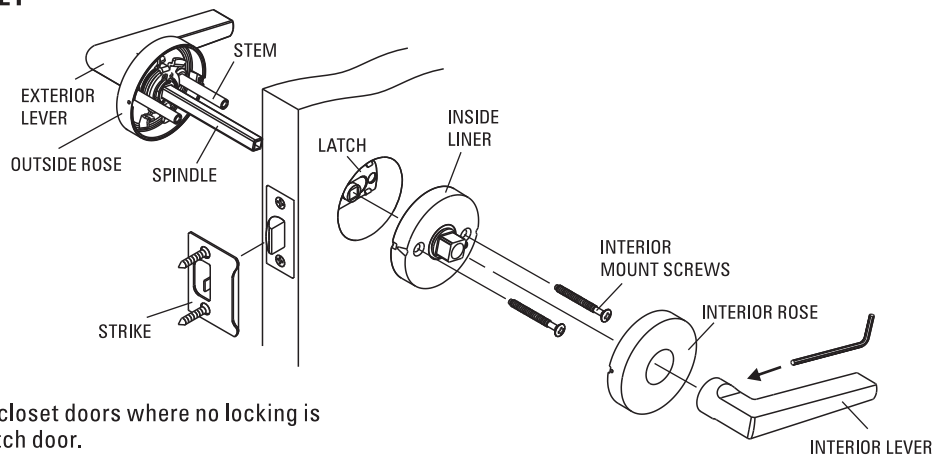

Passage lever set is for hall / closet doors where no locking is required. Depress lever to latch door.

TEMPLATE



Fit here on door edge

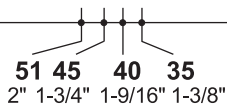

Mark 1" (25.4mm) hole at center of door edge.

BACKSET 70mm (2-3/4")

BACKSET 60mm (2-3/8")

54mm (2-1/8")

