

**ASSEMBLY INSTRUCTIONS
CONSIGNES D'ASSEMBLAGE
INSTRUCCIONES DE ENSAMBLAJE
DS-D206-291-984**

Thank you for purchasing this quality product. Be sure to check all packing material carefully for small hardware which may have come loose inside the carton during shipment. Identify and count all hardware listed on this sheet.

Merci d'avoir acheté ce produit de qualité. Assurez-vous de vérifier dans tous les matériaux d'emballage si de petites pièces de quincaillerie se sont libérées dans la boîte en cours de transport. Identifiez et comptez toute la quincaillerie de la liste.

Gracias por comprar este producto de calidad. Asegúrese de revisar con cuidado todo el material de embalaje, es posible que elementos pequeños de ferretería hayan quedado sueltos entre la caja de cartón durante el envío. Identifique y cuente todos los elementos de ferretería que se presentan en esta hoja.

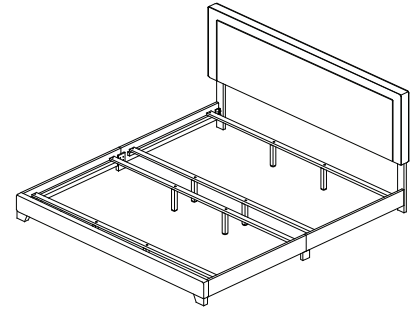





Made in Malaysia
Fabriqué en Malaisie
Hecho en Malasia

When placing furniture on non-carpeted flooring, We recommend the use of floor protection such as an area rug or furniture pads. Area rugs and padding not included with purchase.



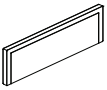
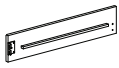
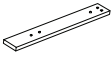
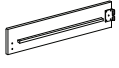
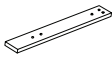
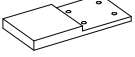
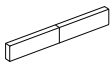



Avant de déposer le meuble sur un revêtement de sol rigide, Il est recommande de protéger le plancher en utilisant une carpepe ou despatins, par exemple. Carpepe et patins non compris.

Antes de colocar el mueble en un suelo sin alfombra, recomendamos protegerlo con un tapete o almohadillas, por ejemplo. Tapete yalmohadillas no incluidos.

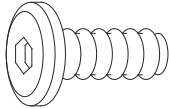
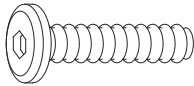
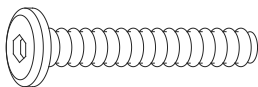
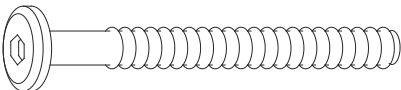
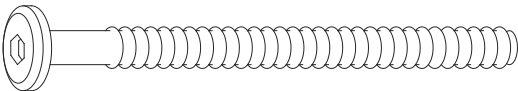
PARTS LIST / LISTE DES PIÈCES / LISTADO DE PARTES

NO: N° : No.:	SKETCH INSTRUCTION ESQUEMA	DESCRIPTION DESCRIPTION DESCRIPCIÓN	Q'TY QTÉ CANTIDAD	NO: N° : No.:	SKETCH INSTRUCTION ESQUEMA	DESCRIPTION DESCRIPTION DESCRIPCIÓN	Q'TY QTÉ CANTIDAD
A		Headboard Panel Tête de lit Panel de cabecera	1	E		Side Rail Côtés de lit Largueros laterales	2
B1		Left Leg Patte de gauche Pata izquierda	1	F		Side Rail Côtés de lit Largueros laterales	2
B2		Right Leg Patte de droite Pata derecha	1	G		Center Support Supports centraux Soportes centrales	2
C		Footboard Panel Pied de lit Tablero de pie de cama	1	H		Slat Lattes Listones	4
D		Foot Pied Pie	2	I		Slat Support Legs Pattes de supports Patatas de apoyo de listones	8

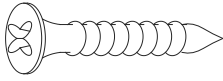
ASSEMBLY INSTRUCTIONS
INSTRUCTIONS D'ASSEMBLAGE
INSTRUCCIONES PARA EL ENSAMBLAJE
DS-D206-291-984

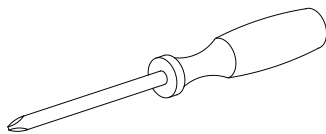
HARDWARE NEEDED / QUINCAILLERIE REQUISE / ELEMENTOS DE FERRETERÍA NECESARIOS			
NO: N° : No.:	SKETCH INSTRUCTION ESQUEMA	DESCRIPTION DESCRIPTION DESCRIPCIÓN	Q'TY QTÉ CANTIDAD
J		Allen Bolt M8 x 20 Vis à tête creuse hexagonale M8 x 20 Perno Allen M8 x 20	8
K		Allen Bolt M6 x 25 Vis à tête creuse hexagonale M6 x 25 Perno Allen M6 x 25	8
L		Allen Bolt M6 x 35 Vis à tête creuse hexagonale M6 x 35 Perno Allen M6 x 35	8
M		Allen Bolt M6 x 50 Vis à tête creuse hexagonale M6 x 50 Perno Allen M6 x 50	6
N		Allen Bolt M6 x 70 Vis à tête creuse hexagonale M6 x 70 Perno Allen M6 x 70	2
O		Wood Dowel Goujon en bois Tarugo de madera	2
P		Spring Washer Rondelle à ressort Arandela auto-bloqueante	14
Q		Flat Washer Rondelle plate Arandela plana	14
R		Screw M4 x 32 Vis M4 x 32 Tornillo M4 x 32	8
S		Allen Wrench M5 x 65 Clé hexagonale M5 x 65 Llave Allen M5 x 65	1
T		Allen Wrench M4 x 65 Clé hexagonale M4 x 65 Llave Allen M4 x 65	1
U		PHILLIPS HEAD SCREWDRIVER (NOT INCLUDED) TOURNEVIS PHILLIPS (NON COMPRIS) DESTORNILLADOR DE ESTRELLA (NO INCLUIDO)	1

