



# **DOUBLE SIDE BURNER/GRIDDLE**

---

**GDSBE1 models**

**USER GUIDE**

**US CA**

**⚠ DANGER**

**IF YOU SMELL GAS**

- Shut off gas to the appliance.
- Extinguish any open flame.
- Open lid.
- If odor continues, keep away from the appliance and immediately call your gas supplier or your fire department.

**⚠ WARNING**

- Do not store or use gasoline or other flammable liquids or vapors in the vicinity of this or any other appliance.
- An LP cylinder not connected for use shall not be stored in the vicinity of this or any other appliance.

# CONTENTS

---

Introduction	3
Safety and warnings	4
Before you begin	9
Lighting instructions   Side burner	10
Lighting instructions   Griddle	12
Leak testing	14
Low flame adjustment	16
Care and cleaning	17
Troubleshooting	18
Warranty and service	19



## INTRODUCTION

---

Bringing the precise control of your indoor cooktop to your outdoor cooking area, the dedicated double side burner lets you simmer your famous BBQ sauce while the ribs are grilling. With 17,000 BTU per burner designed for precise temperature adjustments, you can quickly go from a simmer to a boil, or anywhere in between.

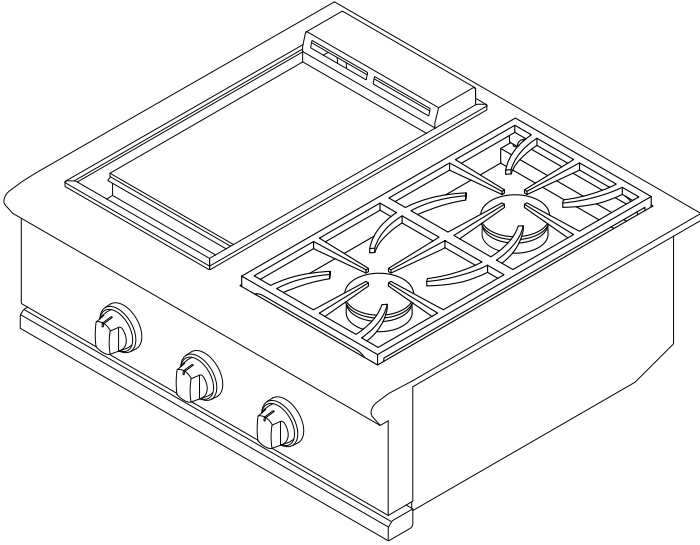

**⚠ WARNING!**



**Electric Shock Hazard**

**Failure to follow this advice may result in electric shock or death.**

- This appliance is equipped with a three-prong or four-prong grounding plug for your protection against shock hazard and should be plugged directly into a properly grounded power outlet.
- Never remove the grounding plug or use with a 2 prong adapter.
- Use only extension cords with a 3 prong grounding plug, rated for the power of the equipment, and approved for outdoor use with a W-A marking.
- Do not immerse cord or plugs in water or other liquid.

**⚠ WARNING!**



**Fire Hazard**

**Failure to follow this advice may result in a fire causing death or serious injury.**

- This unit is for outdoor use only. Do not operate under unprotected combustible construction. Do not use in buildings, garages, sheds, breezeways, covered structures or other such enclosed areas.
- Never store a spare LP cylinder under or near this unit. Do not fill the gas tank more than 80% of its total capacity.
- Do not use aluminium foil to line drip pans. This can interfere with combustion, air flow or trap excessive heat in the control area. The result of this can be melted dials or damaged ignition components.

**⚠ WARNING!**



**Hot Surface Hazard**

**Failure to follow this advice may result in fire, burns, scalds or personal injury.**

- Accessible parts may become hot during use.
- When in use, do not touch the burner, grate, or immediate surrounding area as these areas become extremely hot. Clean the with caution.
- Never let clothing or other flammable materials come in contact with or get too close to any grate, burner or hot surface until it has cooled.
- Never lean over an open unit. When lighting a burner, always pay close attention to what you are doing. Be certain you are pushing the burner dial when you attempt to light.
- Never operate the unit without a drip tray. Let hot grease cool before attempting to handle it. Avoid letting grease deposits collect in the drip pan.
- Ensure all controls are turned off and the unit is cool before using any type of aerosol cleaner on or around the product. The chemical that produces the spraying action could, in the presence of heat, ignite or cause metal to corrode
- Keep any electrical supply cord and the fuel supply hose away from any heated surfaces.

**⚠ WARNING!**



**Excessive weight Hazard**

**Failure to follow this advice may result in personal injury.**

- Two or more people are required to move and install this unit.

### **⚠ WARNING!**



#### **Explosion Hazard**

**Failure to follow this advice may result in injury or death**

- If you smell gas, do not use the appliance.
- Do not use water on grease fires, a violent steam explosion may result. Turn all burners off, then smother fire or flame or use dry chemical or foam-type extinguisher.
- Do not heat unopened food containers such as cans - build up of pressure may cause container to burst and result in injury.

### **WARNING!**

To reduce the risk of fire, injury to persons or damage when using the appliance, follow the important safety instructions listed below. Read all the guidance before using the appliance. Do not use an outdoor cooking gas appliance for purposes other than intended.

#### **Servicing**

- Do not repair or replace any part of the appliance unless specifically recommended in the user guide. All other servicing should be undertaken by a Fisher & Paykel trained and supported service technician or qualified person.
- Only use the product with the type of gas specified on the rating plate. To change gas type a factory conversion kit is required.

#### **Fire Hazard**

- Use only in well ventilated areas.
- Never leave the product unattended when in use.
- Always remove the cover before lighting. Do not replace cover during cooking or before appliance has cooled.
- Do not use a flame to check for gas leaks.
- Do not attempt to disconnect any gas connections while your appliance is in use or the gas supply is on.
- Never connect an unregulated gas line to the appliance.
- Have an ABC rated Fire Extinguisher accessible - never attempt to extinguish a grease fire with water or other liquids.

#### **Storage**

- When not in use, ensure the gas supply is turned off at the supply cylinder.
- Keep appliance covered when not in use
- Storage of the appliance indoors is permissible only if the cylinder is disconnected and removed from the unit.
- Cylinders must be stored outdoors, out of reach of children and must not be stored in a building, garage, or any other enclosed area.



## SAFETY AND WARNINGS

---

- Do not store a full LP tank in direct sunlight.
- After a period of storage or non-use, the appliance should be checked for gas leaks, deterioration, proper assembly, and burner obstructions before use.

### General Use

- This appliance is not intended to be installed in or on recreational vehicles, trailers or boats.
- After lighting burners, ensure they are operating correctly.
- When using the appliance, be sure that all parts of the unit are firmly in place and that everything is stable.
- On cart mounted units, never move without first allowing the appliance to cool, disconnecting the cable and ensuring that the gas supply is turned off.
- Do not move the appliance during use.
- Children should not be left alone or unattended in an area where the product is being used. Never allow them to sit, stand or play on or around the unit at any time.
- Do not store items of interest to children around or below the appliance.
- Never use the appliance in a windy area.
- To put out flare-ups, adjust the controls to lower the temperature.
- Do not obstruct the flow of combustion and ventilation to the appliance.
- Spiders and insects can nest in the burners or openings and can block or restrict the burner. This can cause a flash back to the control panel which can cause a fire.
- Do not try lighting this appliance without reading the lighting instruction in the user guide.
- Do not locate, store or operate the appliance on a slope.
- This product must be installed by a licensed plumber or gas fitter when installed within the Commonwealth of Massachusetts.
- Never use a dented or rusty LP tank. Keep the ventilation openings of the cylinder enclosure free and clear from debris.
- Clean and perform general maintenance on the appliance regularly. Watch for corrosion, cracks, or insect activity. Check the regulator, hoses, burner ports, air shutter, and venturi/valve section carefully. Always turn off gas at the source prior to inspecting.
- You must inspect the unit at least once a year or immediately if the smell of gas is present in conjunction with the burner flames appearing yellow, the appliance does not reach temperature or heats unevenly or the unit makes popping noises.
- Do not smoke while leak testing and extinguish all open flames.
- When cleaning the burners centre the burner onto the orifice correctly and ensure they are level before lighting to prevent fire hazard or explosion. Refer to the user guide for detailed guidance.
- Use only a Ground Fault Interrupter (GFI) protected circuit with this outdoor cooking gas appliance.
- Unplug from the outlet when not in use and before cleaning. Allow to cool before putting on or taking off parts.
- Do not operate the appliance with a damaged cord, plug, or after the appliance malfunctions or has been damaged in any manner. Contact the manufacturer for repair.
- Do not let the cord hang over the edge of a table or touch hot surfaces.
- When connecting, first connect plug to the appliance then plug appliance into the outlet.
- Do not place the unit directly on the ground or other surface without support. This will prevent damage to the regulator/hose assembly.

## SAFETY AND WARNINGS

---

### Gas requirements

- This appliance can be used with any brand of 20lb LP gas tank provided it is compatible with a proper retention device (not supplied).
- The LP gas cylinder must be:
  - Designed for use with a Type 1 system only.
  - Constructed and marked in accordance with the Specifications for LP gas Cylinders of the U.S. Department of Transportation (D.O.T.) or the Standard for Cylinders, Spheres and Tubes for Transportation of Dangerous Goods and Commission, CAN/CSA-B339
  - Provided with a listed overfilling prevention device.
  - Provided with a cylinder connection device compatible with the connection for outdoor cooking gas appliances
- The cylinder must be provided with a shut-off valve terminating in an LP gas supply cylinder valve outlet specified, as applicable, for connection Type 1.
- Do not change the regulator/hose assembly from that supplied with the unit or attempt to use a Type 1 equipped regulator/hose assembly with a standard 510 POL tank/valve assembly.
- Never use a cylinder with a damaged valve. The cylinder that is used must have a collar to protect the cylinder valve.
- An installer-supplied gas shut-off valve must be installed in an easily accessible location
- All installer supplied parts must conform to local codes, or in the absence of local codes, with the National Electrical Code, ANSI/NFPA 70 or the Canadian Electrical Code, CSA C22.1, and the National Fuel Gas Code, ANSI Z223.1 or CSA-B149.1 Natural Gas Installation Code or CSA-B149.2 Propane Installation Code.
- In Massachusetts such shut-off valves should be approved by the Board of State Examiners or Plumbers & Gas Fitters.
- All pipe sealants must be an approved type and resistant to the actions of LP gases. Never use pipe sealant on flare fittings.
- A dented or rusty LP tank may be hazardous and should be checked by your LP supplier.
- Always check for leaks after every LP tank change.
- Gas leak testing must be carried out by a qualified technician.
- For LP units, check for leaks with a full cylinder.
- Do not use the appliance until all connections have been checked and do not leak.
- Before each use, inspect the gas supply piping or hose prior to turning the gas ON. If there is evidence of cuts, wear, or abrasion, it must be replaced prior to use. The pressure regulator and hose assembly supplied with the unit must be used. If replacements are needed, contact customer care at [www.dcsappliances.com](http://www.dcsappliances.com)

## BEFORE YOU BEGIN

- Ensure the installer has completed the final checklist in the installation instructions.
- Read this guide, taking special note of the Safety and warnings section.
- Remove all packaging and dispose of it responsibly. Recycle items that you can.

### Griddle and Side Burner Features

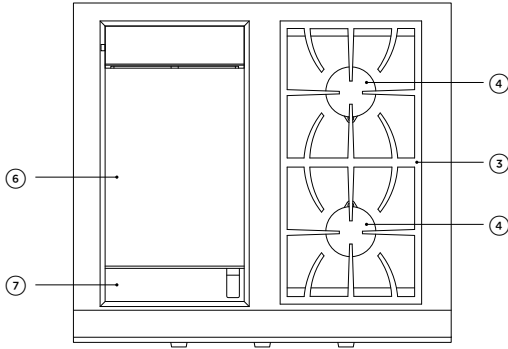

- ① Burner control dials
- ② Griddle control dial
- ③ Burner grates
- ④ Burners
- ⑤ Drip pan
- ⑥ Griddle plate
- ⑦ Grease cup
- ⑧ Griddle vent

Not shown: lid

### Dial halos

When a dial is in use, an orange halo around that dial will illuminate. This will change from orange to white if the dial is turned to **OFF** but another dial remains active. If all dials are turned **OFF**, all halos will dim.

Multiple DCS Series 9 products may be linked together to allow for cross-product halo illumination. To allow for this functionality, an approved DCS kit is required and can be **purchased separately** from your local DCS dealer.

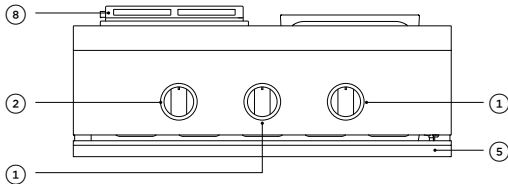

### Seasoning the griddle

- ① Clean the griddle thoroughly with hot, soapy water to remove any protective coating.
- ② Rinse with 1/2 cup of water and 1/4 cup white vinegar. Dry thoroughly.
- ③ Pour 2 teaspoons of vegetable oil into the center of the griddle and rub over the surface.
- ④ Turn the dial to a medium heat setting.
- ⑤ Turn the dial to **OFF** when the oil begins to smoke and allow the griddle to cool. Repeat as needed.

## LIGHTING INSTRUCTIONS | SIDE BURNER

If you are using propane gas, a slight pop or flash may occur at the burner ports a few seconds after the burner has been turned **OFF**. This is normal for propane gas.

1

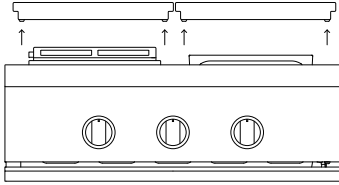

Remove the covers and any cooking utensils. Ensure the drip pan is in place.

2

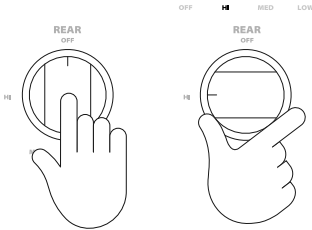

Push in and hold the selected dial for 2 seconds before turning to **HI**. Hold for 5 seconds to light the selected burner.

3

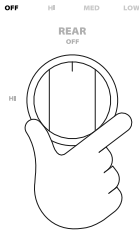

If burner does not light in 5 seconds, turn dial back to **OFF** and wait 5 minutes before trying again. This will allow any accumulated gas to dissipate.

# LIGHTING INSTRUCTIONS | SIDE BURNER

## Manual lighting

If the burner will not light after several attempts, the burner can be manually lit. If you have attempted to light the burner with the ignition, allow 5 minutes for any accumulated gas to dissipate.

1

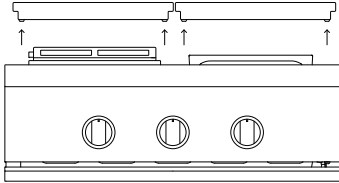

Remove the covers and any cooking utensils. Ensure the drip pan is in place.

2

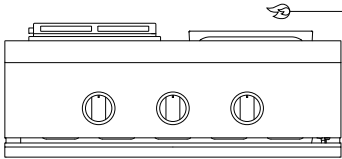

Using a match extension rod, carefully light a match and hold it near the desired burner port.

3

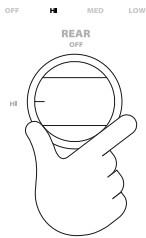

Turn the control dial counter-clockwise to HI.

4

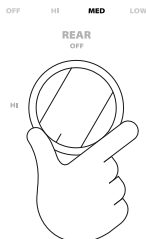

Once burner is lit, turn dial to desired setting.

## LIGHTING INSTRUCTIONS | GRIDDLE

The griddle burner is equipped with a thermocouple and safety valve system which monitors the burner. This will turn the gas off if the burner isn't lit.

1

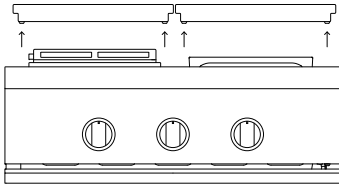

Remove the covers and any cooking utensils. Ensure the drip pan is in place.

2

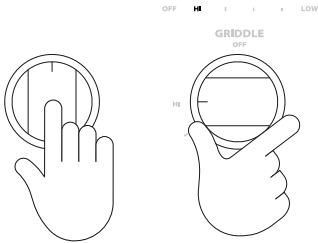

Push in and hold the selected dial for 2 seconds before turning to **HI**. Hold for 10 seconds to light the griddle.

3

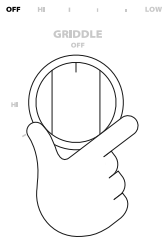

If burner does not light after several attempts turn the dial to **OFF** and refer to the troubleshooting section.

## LIGHTING INSTRUCTIONS | GRIDDLE

### Manual lighting

If the burner will not light after several attempts, the burner can be manually lit. If you have attempted to light the burner with the ignition, allow 5 minutes for any accumulated gas to dissipate.

1

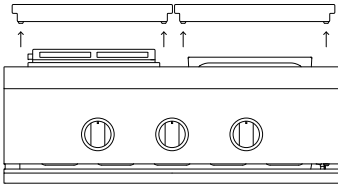

Remove the covers and any cooking utensils. Ensure the drip pan is in place.

2

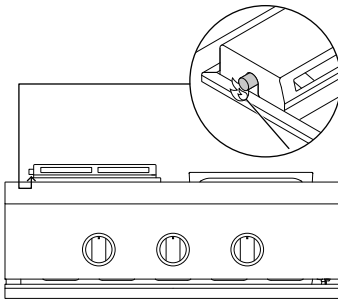

Using a match extension rod, carefully light a match and hold up against the base of the flash tube as shown.

3

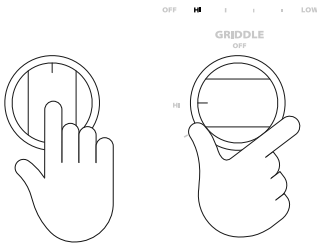

Turn the control dial counter-clockwise to HI. Hold for 10 seconds.

4

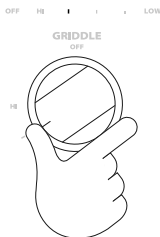

Once burner is lit, turn dial to desired setting.

## LEAK TESTING

---

A complete gas tightness check must be performed at the installation site. Periodically check the whole system for leaks, or immediately if the smell of gas is present.

### Removing the valve panel

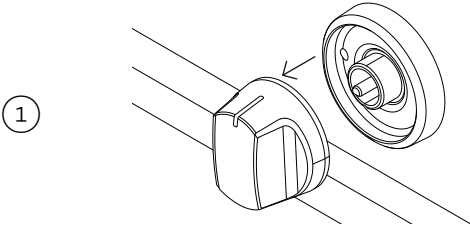

Remove all dials by pulling outwards.

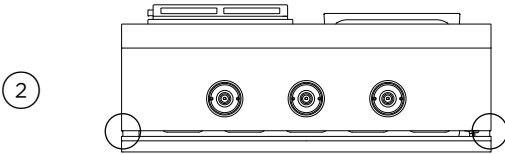

Remove the 2 screws securing the valve panel to the unit using a Phillips screwdriver.

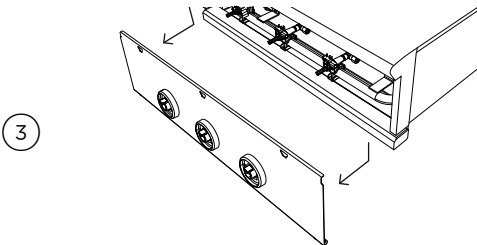

Pull the valve panel down then outward and unplug any wires.



# LEAK TESTING

## Testing for leaks

1

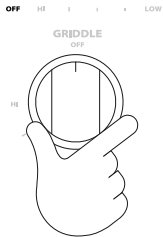

Prepare soap solution by combining one part liquid detergent and one part water. Pour into a spray bottle. Ensure all control valves are in the **OFF** position before turning the gas supply **ON**.

2

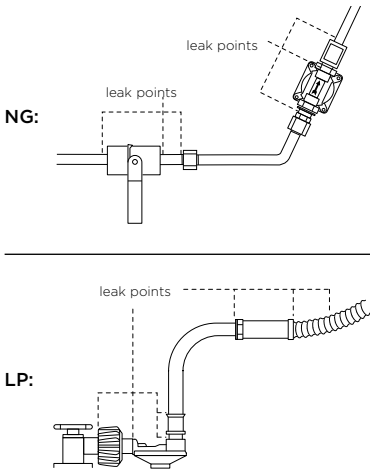

Check all connections from the supply line or LP cylinder by applying the solution around the connection, tubing and end of the manifold. Soap bubbles will appear where a leak is present.

### If a leak is present

Immediately turn the gas supply **OFF** and tighten any leaking connections. Turn gas **ON**, and recheck. If you cannot stop a gas leak turn the gas supply **OFF** and call your local gas utility or the dealer you purchased the appliance from. Only parts recommended by the manufacturer should be used on the side burner/griddle, substitution can void the warranty.

### Changing the LP cylinder

Ensure the main tank valve is turned off before turning the coupler counter clockwise, the inlet will then disengage. Remove the inlet from the tank valve opening. Your local LP filling station should be equipped with the proper equipment to fill your tank.

**Do not attempt to remove, repair or replace the regulator/hose assembly. This must be done by qualified and licensed technician only.**

## LOW FLAME ADJUSTMENT

The valves on the double side burner/griddle unit feature an adjustable low setting. Due to fluctuations in gas pressure, or heating value you may feel it necessary to increase or decrease gas flow in the low position. If the gas type has been converted from natural to LP or vice-versa, the low flame setting must be reviewed and adjusted.

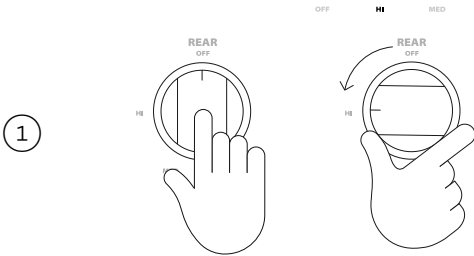

Push in and hold the selected dial for 2 seconds before turning to **HI**. Hold for 10 seconds to light the selected burner.

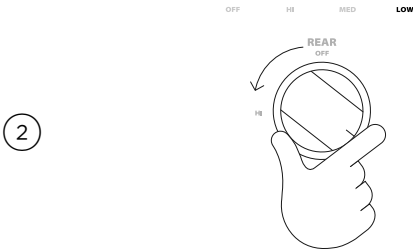

Turn the control dial counter-clockwise to the lowest setting.

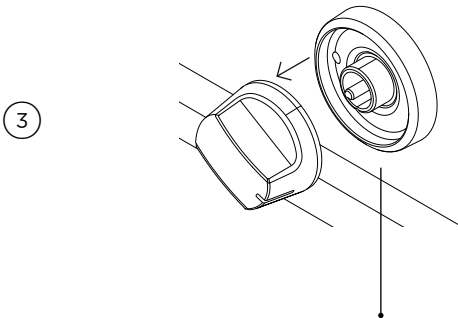

Remove the dial.

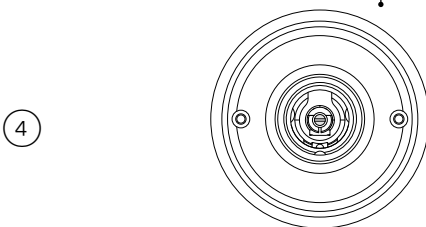

While holding the valve shaft with pliers, insert a flat-tipped screwdriver into the shaft and, while viewing the burner, adjust to a minimum stable flame.

BEZEL FRONT VIEW

## CARE AND CLEANING

### Stainless steel

Always use the mildest cleaning method first. Do not use steel wool to clean the product as it will scratch the surface.

### Burner grates

For durability and optimal performance, the side burner grates are crafted using porcelain enamel over cast iron. It is recommended that the grates are cleaned while in place, however if removing the grates take care as they are heavy and ensure they are placed on a protected surface. Grates can be cleaned using hot soapy water.

Due to rapid temperature changes the porcelain may lift from the edges of the grates. If the grates develop chips do not be concerned, over time the cast iron will darken to blend with the enamel. When wiping areas where the enamel has lifted take care as the edges may be sharp.

### Drip tray

To clean the drip tray, pull tray forward to remove. Wipe spills as soon as possible to prevent them becoming baked on.

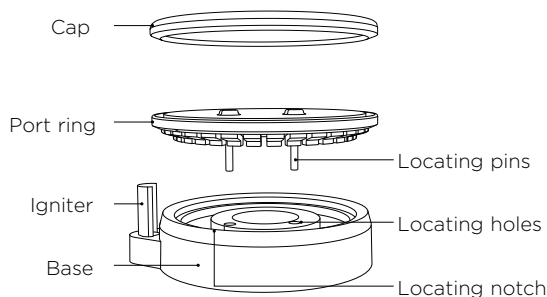

### Cleaning burner parts

- ① Ensure all burner dials are in the **OFF** position and all surfaces are cool.
- ② Remove the burner cap and port ring and wash in hot soapy water, rinse and dry. The burner ports can be cleaned using a bristled brush if needed.
- ③ After cleaning, ensure the locating pins are correctly aligned. Incorrect alignment can cause poor burner performance and dangerous flames.

### Griddle

The griddle assembly should not be removed for cleaning.

#### After each use:

- ① While the griddle is still hot, remove all food particles using a brass brush.
- ② Wait for the griddle to cool to a medium heat before rubbing the surface lightly with vegetable oil.
- ③ Remove the grease cup and wipe clean.
- ④ Wipe the griddle thoroughly to remove any residue or food particles.

#### To remove excess grease build up:

- ⑤ Apply 1 tablespoon of vinegar and ½ cup of water to the griddle plate.
- ⑥ Clean with a scouring cloth taking care not to scratch surface.
- ⑦ Re-season the griddle follow instructions on page 9.

The griddle will naturally darken over time, this is normal and does not require any additional cleaning. To remove any heat discoloration a stainless steel cleaner can be used.

## TROUBLESHOOTING

<b>PROBLEM</b>	<b>POSSIBLE CAUSES</b>	<b>WHAT TO DO</b>
<b>The burner won't light when the ignition is pushed</b>	There is no gas flowing to the unit.	Check gas supply and connections. Ensure no air is trapped in line.
	There is something blocking the air or gas flow.	Check all openings for blockages.
<b>Burner flame is yellow or orange in conjunction with the odor of gas.</b>	Dirt or dust may be present in the area.	Move to a less dusty area and check for obstructions.
	incorrect gas supply or type.	Confirm gas supply and type.
<b>Lo heat with dial in the HI position.</b>	Fuel hose may be bent or kinked.	Check hose is routed correctly.
	Burner may need cleaning.	Follow cleaning instructions.
	If using LP gas, supply may be low or empty.	Check supply, refill tank if needed.
<b>Dial halos don't illuminate.</b>	Power supply is off. GFI has tripped (Ground Fault Interrupter).	Check that the unit is connected to a live AC power source. Check GFI outlet, reset if tripped. Check power supply fuse, replace if blown.
<b>Burner power too high in the LOW position</b>	Low flame setting has been incorrectly set.	Refer to 'Low flame adjustment' for details.

## WARRANTY AND SERVICE

---

### Before you call for service or assistance

Refer to the installation instructions and your user guide and check that:

- Your product is correctly installed.
- You are familiar with its normal operation.
- Model number (can be found on the inside, right side panel behind the drip pan handle.
- Serial number (can be found on the inside, right side panel behind the drip pan handle.
- Code (can be found on the inside, right side panel behind the drip pan handle.
- Date of installation

If after checking these points you still need assistance or parts, please refer to the Service & Warranty book for warranty details and your nearest Service Centre, Customer Care, or contact us through our website [www.dcsappliances.com](http://www.dcsappliances.com) or email: [customer.care@dcsappliances.com](mailto:customer.care@dcsappliances.com)

Complete and keep for safe reference:

Mode \_\_\_\_\_

Serial No. \_\_\_\_\_

Purchase Date \_\_\_\_\_

Purchaser \_\_\_\_\_

Dealer \_\_\_\_\_

Suburb \_\_\_\_\_

Town \_\_\_\_\_

Country \_\_\_\_\_

**DCSAPPLIANCES.COM**

© Fisher & Paykel Appliances 2019. All rights reserved.

The product specifications in this document apply to the specific products and models described at the date of issue. Under our policy of continuous product improvement, these specifications may change at any time. You should therefore check with your Dealer to ensure this booklet correctly describes the product currently available.

**US CA**  
**592075A 11.19**