



PROSERIES LUXURY VINYL FLOORING

INSTALLATION & CARE GUIDE

RIGID CORE CLICK

Daltile | Dal-Tile Corporation
7834 C.F. Hawn Freeway
Dallas, TX 75217

TECHNICAL SERVICES
1.800.933.TILE



PROSERIES LUXURY VINYL FLOORING

INSTALLATION & CARE GUIDE

[CLICK INSTALLATION](#)

Product Description	Grade Levels	Installation Method
Rigid Luxury Vinyl Flooring	Above, On and Below	Click Lock

KEY INSTALLATION CONSIDERATIONS

- DalTile® ProSeries™ LVF Rigid Click is intended for interior use only and is suitable for applications above, on, and below grade. **DO NOT** install in any outside areas, saunas, seasonal porches, camping trailers, boats, RVs, lanais, rooms that are prone to flooding, or rooms or homes that are not temperature-controlled.
- ProSeries LVF Rigid Click is a floating floor and should be allowed to expand and contract freely. It must not be glued, nailed, or fastened to the subfloor in any way. Permanent cabinets, vanities, islands and similar items should be installed first. Then, install the Rigid Click LVF around them, leaving the proper expansion gap. The product can be installed under vanities with legs and under toilets. Leave proper expansion space around the flange and use a premium waterproof 100% silicone caulk. Do not anchor toilet through the material.
- ProSeries LVF Rigid Click is a waterproof floating floor, but it should not be used to seal an existing floor from moisture. It does not inhibit the growth of mold or prevent structural problems associated with or caused by flooding, excessive moisture, alkalis in the subfloor or conditions arising from hydrostatic pressure. Regardless of location, always remove standing water and other liquids promptly. Job site moisture issues should be addressed and corrected prior to installation. Fill expansion spaces around potential wet areas only with premium waterproof 100% silicone caulk.
- Long-term exposure to direct sunlight can potentially damage flooring, causing it to discolor, fade or buckle. Protect LVF from exposure to direct sunlight via the use of window treatments or UV-tinting on windows.

- If the flooring is to be installed by a third party, then it is suggested that the homeowner be present during the installation for consultation and/or direction. The owner and installer should discuss installation and layout to maximize satisfaction. If this is not possible, consultation should occur prior to installation. The owner/installer assumes all responsibility for quality of completed installation.

BEFORE STARTING

Before beginning a ProSeries LVF Rigid Click installation project, it is critical that you 1) fully acquaint yourself with the detailed installation instructions for your specific flooring and subfloor type, and 2) conduct a complete job site evaluation.

- For proper installation, please review this guide in its entirety.
- Make a complete job site evaluation to assure that environmental conditions are acceptable for LVF. Room temperature conditions must be controlled between 50°F and 80°F 48 hours before, during and after installation. Product must be acclimated in this controlled environment for a minimum of 48 hours prior to installation, and stacked no more than 5 cartons high on a flat surface and away from any heating or cooling ducts or direct sunlight. For more detail, please reference the "Installation Prep" section of this guide.
- Determine the quantity of ProSeries LVF Rigid Click and flooring transitions needed for your installation. It is recommended that you add an additional 10% to your square footage for standard installations to account for cuts. For diagonal installations, add 15%.
- Make sure you have the appropriate installation tools. A list of recommended installation tools can be found in the "Tools Required for Installation" section of this guide.

PROSERIES LUXURY VINYL FLOORING

INSTALLATION & CARE GUIDE

CLICK INSTALLATION



Product Description	Grade Levels	Installation Method
Rigid Luxury Vinyl Flooring	Above, On and Below	Click Lock

TOOLS REQUIRED FOR INSTALLATION

- ✓ Tape Measure
- ✓ Utility Knife
- ✓ Eye Protection
- ✓ Gloves
- ✓ Tapping Block
- ✓ Soft Faced Hammer
- ✓ Pull Bar
- ✓ Miter or Circular Saw
- ✓ Carpenter's Square
- ✓ Square Ruler
- ✓ Chalk Line
- OPTIONAL:**
- ✓ Reciprocating Saw
- ✓ 1/4" Spacers
- ✓ Level

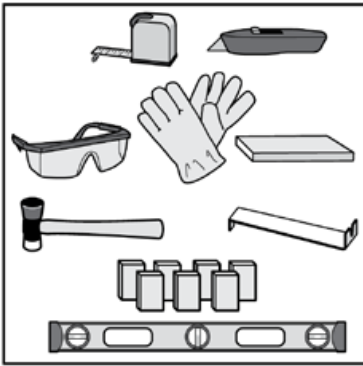

SITE PREPARATION

Prior to installation, the homeowner or installer must ensure that job site conditions (including subfloor or substrate, ambient temperature and relative humidity) will not negatively affect the floor. The manufacturer is not responsible for damages associated with improper installation or poor site conditions.

A. The surface of the subfloor must be flat. The flatness requirement is defined as follows: the maximum difference between two high points and the intermediate low point is 1/4" in a 10' radius. Surface flatness must not vary more than 1/16" when measured with a 3' straight edge. Additionally, the subfloor must not slope more than 1" in 6'.

B. High areas can be sanded, ground down or floated over with an approved self-leveling compound. Fill excessive voids or low areas using a non-gypsum, cementitious based leveling compound. Allow the leveling compound to dry thoroughly before beginning the LVF installation. Follow the manufacturer's instructions to ensure leveling compound is appropriate for the application.

C. Subfloors must be structurally sound without deflection. Cartons should be evenly stacked no more than five cartons high on a flat surface and away from any heating or cooling ducts or direct sunlight.

D. Crawl Spaces: Concrete slab or ground must be dry. Ensure that crawl spaces have open vents year round to ensure proper air circulation and prevent moisture build-up. The ground in the crawl spaces must be completely covered using 6 mil polyethylene. Crawl space clearance between the earth and underside of joists should be no less than 18" (45.7cm), and the perimeter vent area should be equal to 1.5% of the total square footage of the crawl space or as mandated by code. Insulate and protect crawl space with a vapor barrier.

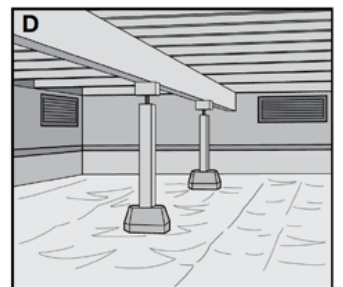
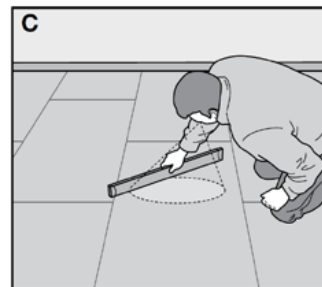
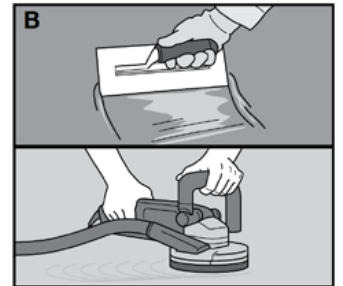
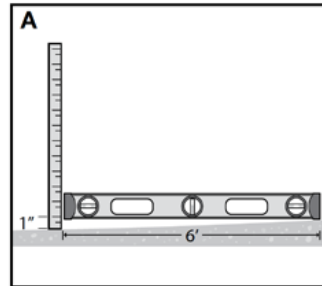

PROSERIES LUXURY VINYL FLOORING

INSTALLATION & CARE GUIDE

CLICK INSTALLATION



Product Description	Grade Levels	Installation Method
Rigid Luxury Vinyl Flooring	Above, On and Below	Click Lock

E. Carefully remove any existing quarter round or base board molding.

F. Always remove carpet, carpet pad and tack strips.

G. Remove any existing floating or un-adhered flooring.

H. Be sure the surface of the subfloor is flat, clean, dry, and sound before starting.

I. Inspect every plank for any shipping damage when removing from the carton.

J. Kitchen cabinets must be installed before the floor is installed. Do not install cabinets on top of ProSeries LVF Rigid Click flooring.

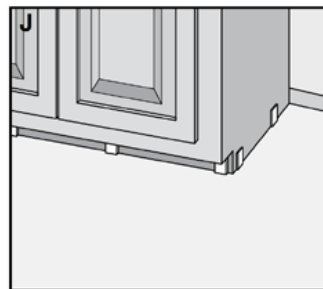
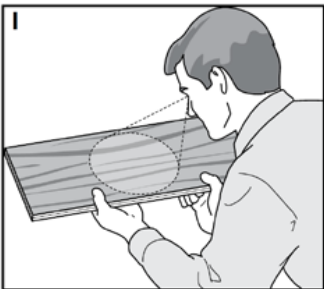
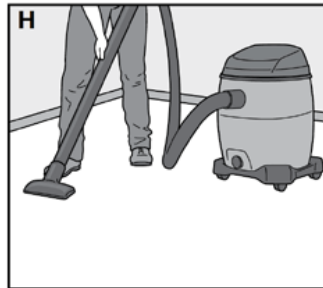
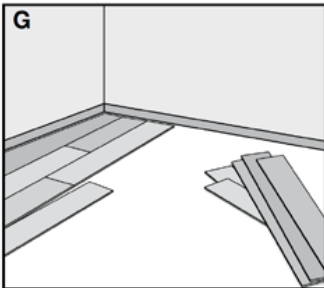
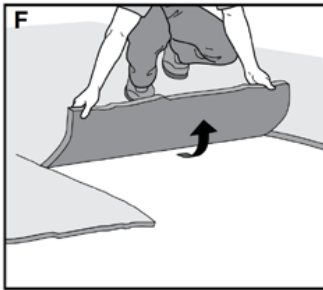
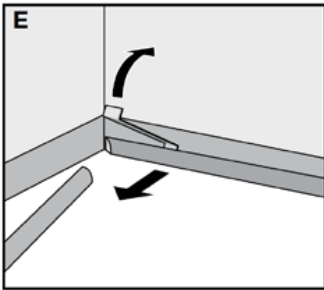

APPROVED SUBFLOORS

Concrete, plywood, OSB, particleboard, chipboard, hardwood (solid, engineered, parquet), tile (ceramic, terrazzo, stone, peel and stick), non-cushion sheet vinyl, metal, VCT and DRIcore are acceptable substrates. All subfloor requirements noted below must be met prior to the installation of ProSeries LVF Rigid Click Flooring.

CONCRETE SUBFLOOR PREP

- New and existing concrete subfloors should meet the guidelines of the latest edition of ACI 302 and ASTM F 710, "Standard Practice for Preparing Concrete Floors for Receiving Resilient Flooring," available from the American Society for Testing and Materials.
- Perform moisture tests at locations around exterior doorways, near walls containing plumbing, near foundation walls and in the center of the room.
- High spots can be removed by grinding. Depressions can be filled with patching compound formulated for use in floor installation.
- Newly-laid concrete slabs must cure for at least 90 days prior to installation.
- Concrete can be either sealed or unsealed.
- Moisture levels of concrete slabs before, during and after installation must be $\leq 8\text{lbs}/1000\text{ft}^2/24\text{-hr}$ using an anhydrous calcium chloride test according to ASTM F1869, and pH must be between 5.0 and 9.0; or, if using ASTM F2170 in-situ probes, relative humidity should be less than 90%. Always measure, record, and retain your testing results.

WOOD SUBFLOORS

(Plywood, OSB, Particleboard, Chipboard, Solid Hardwood, Luan)

- Wood subfloors must be APA approved with a minimum grade of BB or CC. (For reference, APA refers to the American Plywood Association, now known as the Engineered Wood Association).
- Double-layered APA rated wood subfloors should be a minimum 1" total thickness, with at least 18" well-ventilated air space beneath.



Product Description	Grade Levels	Installation Method
Rigid Luxury Vinyl Flooring	Above, On and Below	Click Lock

- Perform moisture tests using a reliable moisture meter in multiple locations. Moisture readings should never exceed 14% for plywood, OSB, particleboard, chipboard or solid hardwood subfloors. If moisture readings exceed 14%, conditions must be corrected at the job site before installation.
- It is recommended that your chosen APA underlayment be designed for installation under resilient flooring and carry a written warranty.
- Always follow the underlayment manufacturer's installation instructions.
- Wood subfloors directly fastened to concrete, or sleeper construction, are not recommended.

OTHER SUBFLOOR PREP

- Adhered and sound vinyl sheet goods, vinyl tiles, linoleum and resilient (VCT) tiles usually do not need to be removed if they are fully bonded and free of any notable damage. Some older vinyl sheet goods and tile contain asbestos. Should existing flooring contain asbestos, special precautions must be taken for your safety. Contact a professional immediately for inspection and removal.
- Ceramic tiles and terrazzo usually do not need to be removed. Grout joints wider than 1/4" must be filled. LVF may be installed directly over ceramic tiles and terrazzo, provided they are fully adhered, smooth, sound and dry. These flooring materials must be smooth and flat to within 1/4" in a 10' radius and must not vary more than 1/16" when measured with a 3' straight edge.
- Do not install over more than one layer of existing vinyl.

RADIANT FLOORING HEATING PREP

- After market radiant heated floors must be approved by the manufacturer for use with resilient flooring applications.
- The subfloor temperature be between 45°F and 85°F.

SUBFLOORS NOT APPROVED

- Carpeting/Carpet Pad
- Cushioned Vinyl Flooring
- Floating Floors
- Laminate
- Parquet Over Concrete
- Cork
- Engineered Hardwood Over Concrete
- Sleeper Substrates
- Hardwood Over Concrete
- Rubber

NOTE: Remove the floors listed above and remove old adhesive before installing LVF.

INSTALLATION PREPARATION

- ProSeries LVF Rigid Click is intended for indoor use only.
- Room temperature conditions must be controlled between 50°F and 80°F and humidity below 65% for 48 hours before, during and after installation. Product must be acclimated in this controlled environment for a minimum of 48 hours prior to installation, and stacked no more than 5 cartons high.
- A 3/8" (9mm) expansion space must be maintained around the perimeter of the room and any fixed objects such as pipes or columns.
- Use approved safety equipment to provide proper protection based on each given task.
- Door-jambs and casings must be undercut so that the plank can slide underneath. A 1/4" (6 mm) expansion space must also be included around the undercut jambs and casings. A reciprocating saw is recommended to create the necessary undercut. Never undercut metal door casings. **Cutting Tip:** To undercut the casting, lay a scrap piece of flooring next to the casting and lay the saw flat on top of the flooring so that the saw easily cuts to the height of the plank.

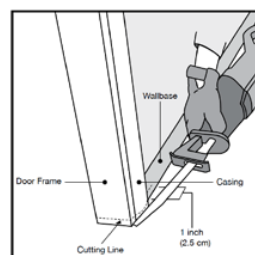

PROSERIES LUXURY VINYL FLOORING

INSTALLATION & CARE GUIDE

CLICK INSTALLATION



Product Description	Grade Levels	Installation Method
Rigid Luxury Vinyl Flooring	Above, On and Below	Click Lock

IMPORTANT: Always inspect each plank to ensure it is not damaged prior to installation. Check the tongue and groove to ensure both are free of debris or damage.

- It is recommended to blend flooring from multiple cartons during installation.
- Cartons should be evenly stacked no more than five cartons high on a flat surface and away from any heating or cooling ducts or direct sunlight.
- Excess flooring should be stored in a protected and climate controlled environment for possible future repairs.
- The HVAC system must be on and functional before, during and after installation.
- Power tools can be dangerous. Operate in strict accordance with manufacturer's operating instructions and safety precautions. Unsafe and improper use can cause serious injuries. Avoid inhalation and exposure to airborne particles by wearing personal protective equipment, including: NIOSH or OSHA approved dust masks, safety goggles and work gloves.

CLICK LOCK INSTALLATION

1. Inspect each plank. Blend planks from several cartons at the same time to ensure good color and shade mixture throughout the installation.
2. The first plank of the first row should be a full length plank. It is recommended that installation begin in a corner of the room. Between the first row of flooring and the wall, insert spacers so that a 3/8" (9mm) gap is maintained. The entire installation requires a 3/8" expansion space.
3. When installing the first row, insert the short edge of one plank into the short edge of another plank at slight angle and rotate downward. Continue to complete the starter row, maintaining a straight edge for the following row.
4. Use a tapping block and soft faced hammer to close any gaps between the planks.

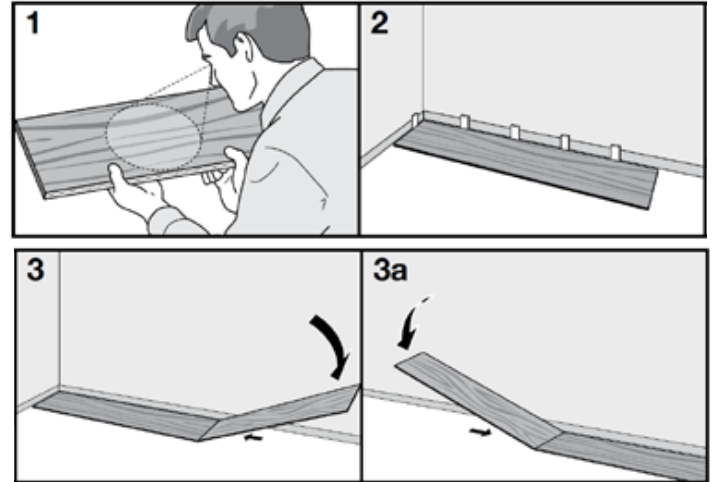

5. Once you reach the end of the first row, measure and cut the final plank so that it completes the row while also leaving the necessary 3/8" expansion gap. Last planks of rows must be at least 8" long. Note: Use a spare plank to create a straight edge at the cut line. Use a utility knife to score the top of the pattern and snap the panel. It will be necessary to cut the foam underlayment after snapping the panel.
6. Start the second row of flooring by using the trimmed planks from the previous row. First pieces must be at least 8" long. End joints should be staggered a minimum of 6" from one row to the next.
7. At a slight angle, insert the long edge tongue of the first plank in row 2 into the long edge groove of the plank in row 1 until the plank edges meet, and then rotate down until the joints lock.
8. When joining the next plank in the second row, join the short side edges first. There will be a gap on the long side joints when the plank is rotated down.
9. Raise the outside long edge of the plank upward approximately 1". Maintain this angle as you push the plank in until the long edge of the plank meets the long edge of the first row. Rotate downward on the plank until the joint locks.

PROSERIES LUXURY VINYL FLOORING

INSTALLATION & CARE GUIDE

[CLICK INSTALLATION](#)



Product Description

Rigid Luxury Vinyl Flooring

Grade Levels

Above, On and Below

Installation Method

Click Lock

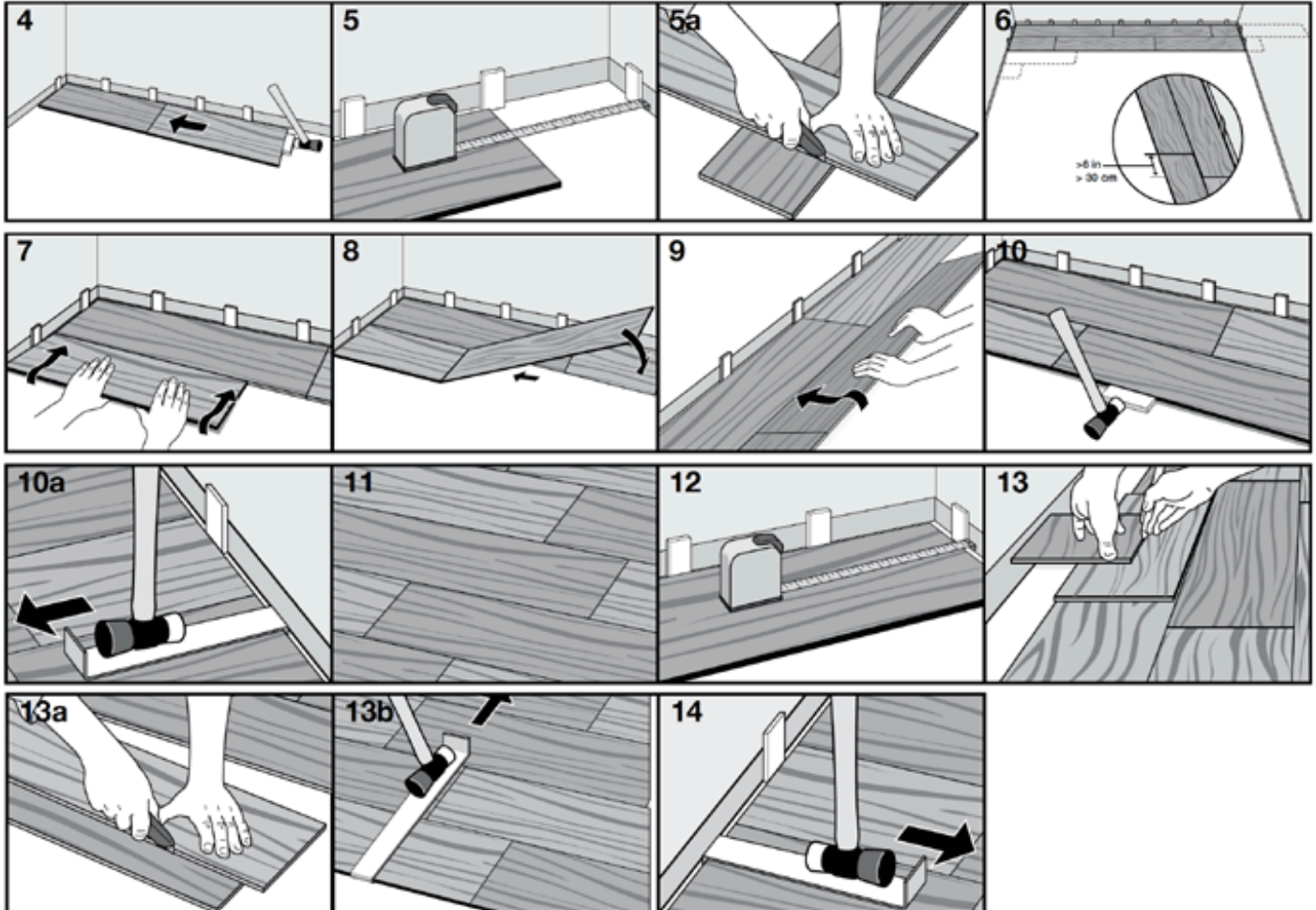

10. After tapping the long side joint closed, close the short edge joints using a tapping block or pull bar.

11. Repeat these steps to complete the installation.

12. After each row is complete, ensure there will be a 3/8" (9mm) gap to the wall, after the joints are closed, for expansion.

13. For the last row, align the plank to be used on top of the 2nd to last row. Using a full width plank as a spacer, trace the wall contour. Use a full plank as a straight edge to cut the plank. Insert the long edge tongue in to the long edge groove and use a pull bar and hammer to close the gap.

14. After tapping the long side joint closed, close the short edge joints using a tapping block or pull bar.



Product Description	Grade Levels	Installation Method
Rigid Luxury Vinyl Flooring	Above, On and Below	Click Lock

15. When the new flooring meets a threshold or a doorway, we recommend undercutting the door jamb. To secure the right cut, turn a plank upside down and place it on the floor up to the door frame. Then place a reciprocating saw flat against the plank and simply cut through the frame. Remove the cut-out piece and vacuum away debris. Slide plank under pre-cut door frame. Door frame should be cut so that a 3/8" (9mm) gap is located from the edge of the plank under the casing to the wall.

16. Tap the long side joint closed first, then tap the end joint closed.

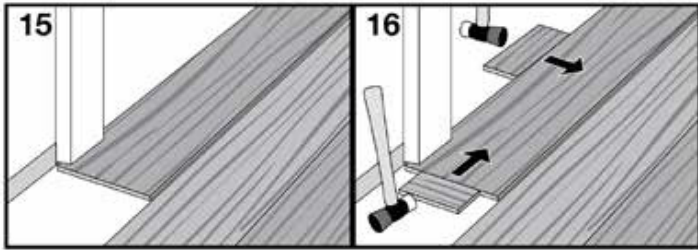

17. In place of a resilient tile cutter, a miter or circular saw with the blade cutting into the design of the planks can be used to cut the rigid luxury vinyl floors. A utility knife can also be used, scoring the top of the pattern and snapping the plank. It will be necessary to cut the foam underlayment after snapping the plank.

NOTE: Maintain a 3/8" (9mm) expansion space around all walls and vertical objects. Quarter round or baseboard molding will cover this expansion space.

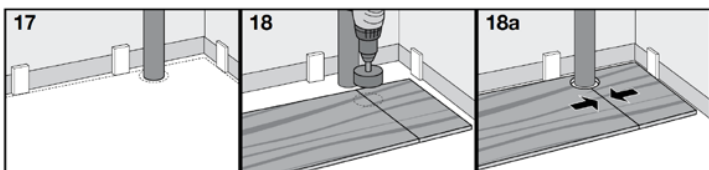

INSTALLING AROUND FIXED OBJECTS

18. Allow 3/8" (9mm) expansion space around pipes or other fixed objects.

19. In rows where there is a pipe, make sure the pipe falls exactly in line with the short side of two planks. Select a drill bit with the same diameter as the pipe plus 1/2" (13 mm). Click the planks together on the short side and drill a hole centered on the joint between the two planks. Then install the planks.

20. For a double pipe, drill a hole equivalent to the diameter of the pipe plus 1/2" (13 mm) at each of the marked points. If located on the long side of the plank, make a 45° cut from each hole to the edge of the plank. Then, using an appropriate glue along the cut edges of the piece you cut out, glue the piece in place. Be sure no glue comes between the cut-out piece and the subfloor.

21. Remove all spacers.

22. Fill any expansion spaces around potentially wet areas, such as refrigerators, tubs, etc., with premium waterproof 100% silicone caulk.

23. When installing LVF in any room or area larger than 100 lineal feet (30.5 m) in any direction, the use of a coordinating T-Molding/Reducer transition is required to separate the floor into sections no larger than 100' x 100' (30.5 m x 30.5 m) per section.

24. Install moldings to cover the expansion gap. When installing moldings, never allow nails or screws to enter the LVF or the expansion zone around the flooring perimeter. All moldings and transition strips need to provide a 3/8" (9mm) expansion space as well.

NOTE: Maintain the 3/8" expansion gap around cabinets, pipes, toilet flanges and any obstacles in the floor (it is not recommended to trim around a toilet, however leave the expansion space around the toilet flange).

PROSERIES LUXURY VINYL FLOORING

INSTALLATION & CARE GUIDE

[CLICK INSTALLATION](#)

Product Description	Grade Levels	Installation Method
Rigid Luxury Vinyl Flooring	Above, On and Below	Click Lock

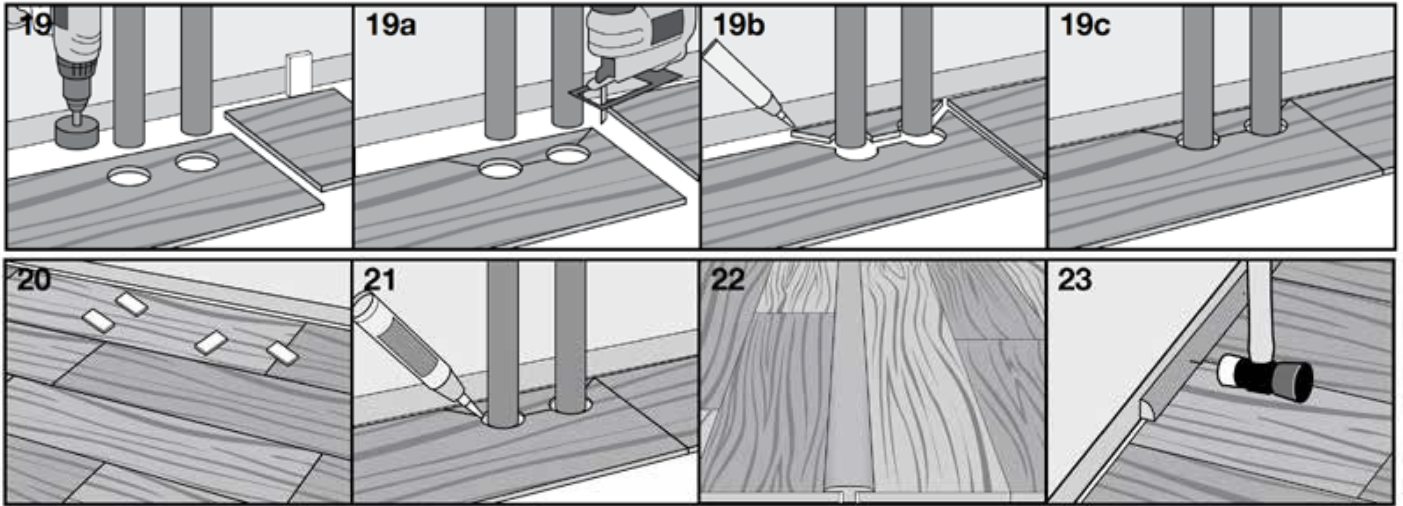

CARING & CLEANING

PREVENTATIVE MAINTENANCE

- Prevent indentations and scratches by using non-staining floor protectors on the legs of chairs, appliances and all heavy furniture. Floor protectors should be at least 1" in diameter. Periodically clean protectors to remove grit that may become embedded and cause scratching.
- Replace plastic or metal chair casters with rubber, and keep casters clean.
- Place walk-off mats at entrances. Mats should have a non-rubberized backing and be labeled as nonstaining.
- We recommend the use of a hard surface (non-studded), non-rubber chair mat to protect your floor from office chairs with casters. Light, rolling furniture should be outfitted with broad-surface, non-staining casters that have been engineered for hard surface floors. Such casters should be a minimum of 1" (2.5 cm) wide and at least 2" (5.1 cm) in diameter.
- Avoid exposure to direct sunlight for prolonged periods of time, as this can cause discoloration. Use of window coverings is recommended.
- Keep pets' nails trimmed.
- Remove shoes with cleats, spikes, or pointed high heels before walking on the floor.

- Protect your floors against burns. Burns from cigarettes, matches or other extremely hot items can cause permanent damage to your luxury vinyl flooring.

CLEANING

- Sweep the floor regularly with a soft bristle broom to remove loose dirt.
- Wash the floor with non-abrasive, neutral PH floor cleaner approved for vinyl floors.
- For every day cleaning, a mop moistened with warm water will suffice.
- Spills should be cleaned up immediately.

CLEANING AGENTS TO AVOID

- Detergent based cleaners
- Abrasive or mop and shine products
- Ammonia or bleaches
- Vacuum cleaner with a rotating beater bar engaged
- Floor wax

NOTE: Always read the cautionary information on all cleaners prior to use.

IMPORTANT: Never push, pull or drag furniture, appliances or other items across the floor. Always lift and carry furniture or heavy items.



PROSERIES LUXURY VINYL FLOORING

INSTALLATION & CARE GUIDE

RIGID CORE CLICK

HERRINGBONE

Daltile | Dal-Tile Corporation
7834 C.F. Hawn Freeway
Dallas, TX 75217

TECHNICAL SERVICES
1.800.933.TILE

PROSERIES™
LUXURY VINYL FLOORING

PROSERIES LUXURY VINYL FLOORING

INSTALLATION & CARE GUIDE

[CLICK INSTALLATION](#)

Product Description	Grade Levels	Installation Method
Rigid Luxury Vinyl Flooring	Above, On and Below	Click Lock

KEY INSTALLATION CONSIDERATIONS

- Daltile® ProSeries™ LVF Rigid Click is intended for interior use only and is suitable for applications above, on, and below grade. **DO NOT** install in any outside areas, saunas, seasonal porches, camping trailers, boats, RVs, lanais, rooms that are prone to flooding, or rooms or homes that are not temperature-controlled.
- ProSeries LVF Rigid Click is a floating floor and should be allowed to expand and contract freely. It must not be glued, nailed, or fastened to the subfloor in any way. Permanent cabinets, vanities, islands and similar items should be installed first. Then, install the Rigid Click LVF around them, leaving the proper expansion gap. The product can be installed under vanities with legs and under toilets. Leave proper expansion space around the flange and use a premium waterproof 100% silicone caulk. Do not anchor toilet through the material.
- ProSeries LVF Rigid Click is a waterproof floating floor, but it should not be used to seal an existing floor from moisture. It does not inhibit the growth of mold or prevent structural problems associated with or caused by flooding, excessive moisture, alkalis in the subfloor or conditions arising from hydrostatic pressure. Regardless of location, always remove standing water and other liquids promptly. Job site moisture issues should be addressed and corrected prior to installation. Fill expansion spaces around potential wet areas only with premium waterproof 100% silicone caulk.
- Long-term exposure to direct sunlight can potentially damage flooring, causing it to discolor, fade or buckle. Protect LVF from exposure to direct sunlight via the use of window treatments or UV-tinting on windows.

- If the flooring is to be installed by a third party, then it is suggested that the homeowner be present during the installation for consultation and/or direction. The owner and installer should discuss installation and layout to maximize satisfaction. If this is not possible, consultation should occur prior to installation. The owner/installer assumes all responsibility for quality of completed installation.

BEFORE STARTING

Before beginning a ProSeries LVF Rigid Click installation project, it is critical that you 1) fully acquaint yourself with the detailed installation instructions for your specific flooring and subfloor type, and 2) conduct a complete job site evaluation.

- For proper installation, please review this guide in its entirety.
- Make a complete job site evaluation to assure that environmental conditions are acceptable for LVF. Room temperature conditions must be controlled between 50°F and 80°F 48 hours before, during and after installation. Product must be acclimated in this controlled environment for a minimum of 48 hours prior to installation, and stacked no more than 5 cartons high on a flat surface and away from any heating or cooling ducts or direct sunlight. For more detail, please reference the "Installation Prep" section of this guide.
- Determine the quantity of ProSeries LVF Rigid Click and flooring transitions needed for your installation. It is recommended that you add an additional 10% to your square footage for standard installations to account for cuts. For diagonal installations, add 15%.
- Make sure you have the appropriate installation tools. A list of recommended installation tools can be found in the "Tools Required for Installation" section of this guide.

PROSERIES LUXURY VINYL FLOORING

INSTALLATION & CARE GUIDE

CLICK INSTALLATION



Product Description	Grade Levels	Installation Method
Rigid Luxury Vinyl Flooring	Above, On and Below	Click Lock

TOOLS REQUIRED FOR INSTALLATION

- ✓ Tape Measure
- ✓ Utility Knife
- ✓ Eye Protection
- ✓ Gloves
- ✓ Tapping Block
- ✓ Soft Faced Hammer
- ✓ Pull Bar
- ✓ Miter or Circular Saw
- ✓ Carpenter's Square
- ✓ Square Ruler
- ✓ Chalk Line
- OPTIONAL:**
- ✓ Reciprocating Saw
- ✓ 1/4" Spacers
- ✓ Level

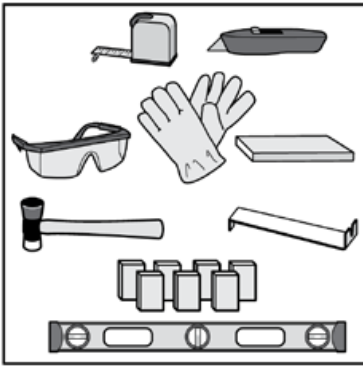

SITE PREPARATION

Prior to installation, the homeowner or installer must ensure that job site conditions (including subfloor or substrate, ambient temperature and relative humidity) will not negatively affect the floor. The manufacturer is not responsible for damages associated with improper installation or poor site conditions.

A. The surface of the subfloor must be flat. The flatness requirement is defined as follows: the maximum difference between two high points and the intermediate low point is 1/4" in a 10' radius. Surface flatness must not vary more than 1/16" when measured with a 3' straight edge. Additionally, the subfloor must not slope more than 1" in 6'.

B. High areas can be sanded, ground down or floated over with an approved self-leveling compound. Fill excessive voids or low areas using a non-gypsum, cementitious based leveling compound. Allow the leveling compound to dry thoroughly before beginning the LVF installation. Follow the manufacturer's instructions to ensure leveling compound is appropriate for the application.

C. Subfloors must be structurally sound without deflection. Cartons should be evenly stacked no more than five cartons high on a flat surface and away from any heating or cooling ducts or direct sunlight.

D. Crawl Spaces: Concrete slab or ground must be dry. Ensure that crawl spaces have open vents year round to ensure proper air circulation and prevent moisture build-up. The ground in the crawl spaces must be completely covered using 6 mil polyethylene. Crawl space clearance between the earth and underside of joists should be no less than 18" (45.7cm), and the perimeter vent area should be equal to 1.5% of the total square footage of the crawl space or as mandated by code. Insulate and protect crawl space with a vapor barrier.

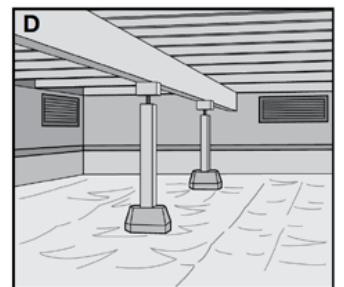
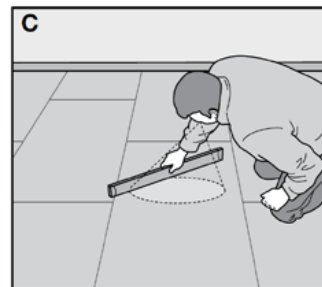
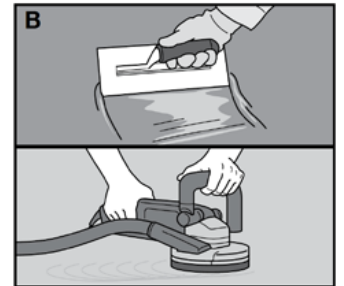
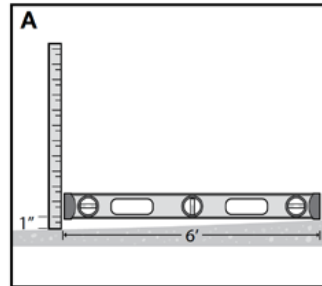

PROSERIES LUXURY VINYL FLOORING

INSTALLATION & CARE GUIDE

CLICK INSTALLATION



Product Description	Grade Levels	Installation Method
Rigid Luxury Vinyl Flooring	Above, On and Below	Click Lock

E. Carefully remove any existing quarter round or base board molding.

F. Always remove carpet, carpet pad and tack strips.

G. Remove any existing floating or un-adhered flooring.

H. Be sure the surface of the subfloor is flat, clean, dry, and sound before starting.

I. Inspect every plank for any shipping damage when removing from the carton.

J. Kitchen cabinets must be installed before the floor is installed. Do not install cabinets on top of ProSeries LVF Rigid Click flooring.

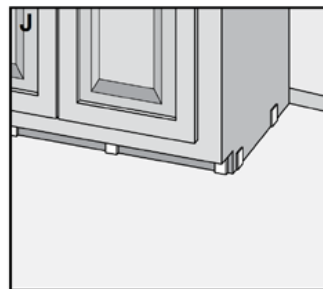
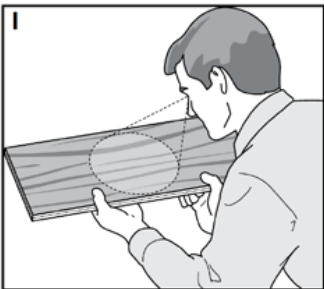
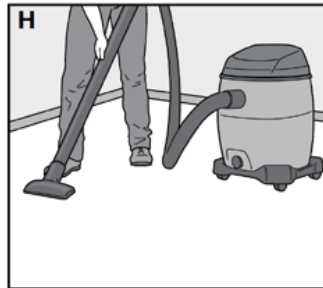
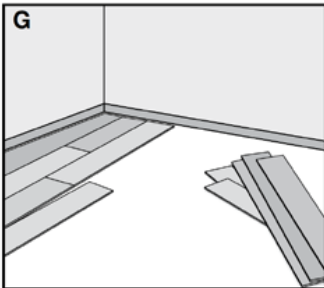
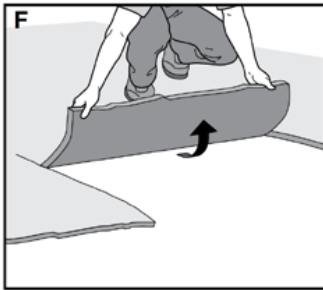
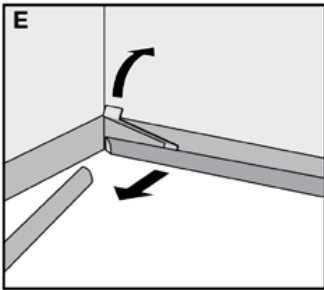

APPROVED SUBFLOORS

Concrete, plywood, OSB, particleboard, chipboard, hardwood (solid, engineered, parquet), tile (ceramic, terrazzo, stone, peel and stick), non-cushion sheet vinyl, metal, VCT and DRIcore are acceptable substrates. All subfloor requirements noted below must be met prior to the installation of ProSeries LVF Rigid Click Flooring.

CONCRETE SUBFLOOR PREP

- New and existing concrete subfloors should meet the guidelines of the latest edition of ACI 302 and ASTM F 710, "Standard Practice for Preparing Concrete Floors for Receiving Resilient Flooring," available from the American Society for Testing and Materials.
- Perform moisture tests at locations around exterior doorways, near walls containing plumbing, near foundation walls and in the center of the room.
- High spots can be removed by grinding. Depressions can be filled with patching compound formulated for use in floor installation.
- Newly-laid concrete slabs must cure for at least 90 days prior to installation.
- Concrete can be either sealed or unsealed.
- Moisture levels of concrete slabs before, during and after installation must be $\leq 8\text{lbs}/1000\text{ft}^2/24\text{-hr}$ using an anhydrous calcium chloride test according to ASTM F1869, and pH must be between 5.0 and 9.0; or, if using ASTM F2170 in-situ probes, relative humidity should be less than 90%. Always measure, record, and retain your testing results.

WOOD SUBFLOORS

(Plywood, OSB, Particleboard, Chipboard, Solid Hardwood, Luan)

- Wood subfloors must be APA approved with a minimum grade of BB or CC. (For reference, APA refers to the American Plywood Association, now known as the Engineered Wood Association).
- Double-layered APA rated wood subfloors should be a minimum 1" total thickness, with at least 18" well-ventilated air space beneath.



Product Description	Grade Levels	Installation Method
Rigid Luxury Vinyl Flooring	Above, On and Below	Click Lock

- Perform moisture tests using a reliable moisture meter in multiple locations. Moisture readings should never exceed 14% for plywood, OSB, particleboard, chipboard or solid hardwood subfloors. If moisture readings exceed 14%, conditions must be corrected at the job site before installation.
- It is recommended that your chosen APA underlayment be designed for installation under resilient flooring and carry a written warranty.
- Always follow the underlayment manufacturer's installation instructions.
- Wood subfloors directly fastened to concrete, or sleeper construction, are not recommended.

OTHER SUBFLOOR PREP

- Adhered and sound vinyl sheet goods, vinyl tiles, linoleum and resilient (VCT) tiles usually do not need to be removed if they are fully bonded and free of any notable damage. Some older vinyl sheet goods and tile contain asbestos. Should existing flooring contain asbestos, special precautions must be taken for your safety. Contact a professional immediately for inspection and removal.
- Ceramic tiles and terrazzo usually do not need to be removed. Grout joints wider than 1/4" must be filled. LVF may be installed directly over ceramic tiles and terrazzo, provided they are fully adhered, smooth, sound and dry. These flooring materials must be smooth and flat to within 1/4" in a 10' radius and must not vary more than 1/16" when measured with a 3' straight edge.
- Do not install over more than one layer of existing vinyl.

RADIANT FLOORING HEATING PREP

- After market radiant heated floors must be approved by the manufacturer for use with resilient flooring applications.
- The subfloor temperature be between 45°F and 85°F.

SUBFLOORS NOT APPROVED

- Carpeting/Carpet Pad
- Cushioned Vinyl Flooring
- Floating Floors
- Laminate
- Parquet Over Concrete
- Cork
- Engineered Hardwood Over Concrete
- Sleeper Substrates
- Hardwood Over Concrete
- Rubber

NOTE: Remove the floors listed above and remove old adhesive before installing LVF.

INSTALLATION PREPARATION

- ProSeries LVF Rigid Click is intended for indoor use only.
- Room temperature conditions must be controlled between 50°F and 80°F and humidity below 65% for 48 hours before, during and after installation. Product must be acclimated in this controlled environment for a minimum of 48 hours prior to installation, and stacked no more than 5 cartons high.
- A 3/8" (9mm) expansion space must be maintained around the perimeter of the room and any fixed objects such as pipes or columns.
- Use approved safety equipment to provide proper protection based on each given task.
- Door-jambs and casings must be undercut so that the plank can slide underneath. A 1/4" (6 mm) expansion space must also be included around the undercut jambs and casings. A reciprocating saw is recommended to create the necessary undercut. Never undercut metal door casings. **Cutting Tip:** To undercut the casing, lay a scrap piece of flooring next to the casing and lay the saw flat on top of the flooring so that the saw easily cuts to the height of the plank.

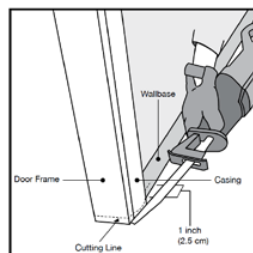

PROSERIES LUXURY VINYL FLOORING

INSTALLATION & CARE GUIDE

[CLICK INSTALLATION](#)



Product Description	Grade Levels	Installation Method
Rigid Luxury Vinyl Flooring	Above, On and Below	Click Lock

IMPORTANT: Always inspect each plank to ensure it is not damaged prior to installation. Check the tongue and groove to ensure both are free of debris or damage.

- It is recommended to blend flooring from multiple cartons during installation.
- Cartons should be evenly stacked no more than five cartons high on a flat surface and away from any heating or cooling ducts or direct sunlight.
- Excess flooring should be stored in a protected and climate controlled environment for possible future repairs.
- The HVAC system must be on and functional before, during and after installation.
- Power tools can be dangerous. Operate in strict accordance with manufacturer's operating instructions and safety precautions. Unsafe and improper use can cause serious injuries. Avoid inhalation and exposure to airborne particles by wearing personal protective equipment, including: NIOSH or OSHA approved dust masks, safety goggles and work gloves.

CLICK LOCK INSTALLATION

Inspect each plank. Blend planks from several cartons at the same time to ensure good color and shade mixture throughout the installation.

A floating installation is normally used for this type of floor covering. The bottoms of the door frames have to be trimmed. It is important to plan the installation before starting it. Proper planning will prevent very narrow pieces against walls and/or short pieces at the ends of the rows.

Every box of flooring contains the same number of left and right-handed machined pieces.

1. Before starting the installation, we recommend stacking the material in two columns - the A pieces and the B pieces.

2. The herringbone installation system should typically be started from a central axis using a chalk line or marking straight lines from the center of the room.

Mark the "X" axis and then mark a second line that is perpendicular to the first one, creating a 90° intersection to create the "Y" axis. This process is essential and a good way of checking that all of the angles and measurements are correct at this point, before you start installing the first boards.

1. Start installing the first three boards, so that the corner of each piece coincides with the "Y" axis, as shown in the diagram. Continue installing by starting with the grooved edges towards you.
2. Use the "Y" line as a guide when installing.
3. When the installation is stable enough, cut out the triangle as shown in the image.
4. Place the first triangle in line with the "Y" axis that marks the center of the room. Repeat the same process with the other triangles until you reach the side walls. Remember to take into account the 10 mm perimeter joint between the pieces and the wall.
5. The sections on the sides where a full triangle cannot be placed should be cut down to the necessary size.
6. When the initial wall is covered, continue with the installation by following the lines that were marked earlier on the floor.
7. Continue installing from left to right, across the room until you have finished.

This product uses a LOCK installation system, following the "angle snap" method.

Use the pull bar or chisel to install the pieces at each end of the installation. When installing each piece, avoid hitting the machined profile so that you don't damage it.

PROSERIES LUXURY VINYL FLOORING

INSTALLATION & CARE GUIDE



Product Description	Grade Levels	Installation Method
Rigid Luxury Vinyl Flooring	Above, On and Below	Click Lock

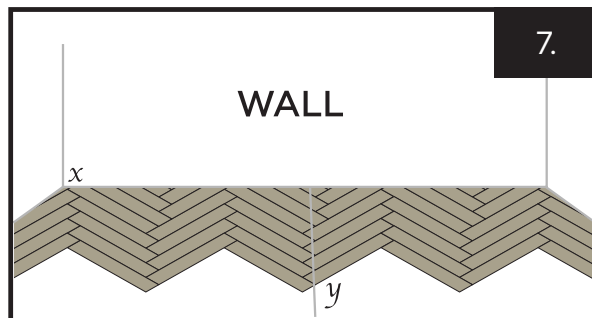
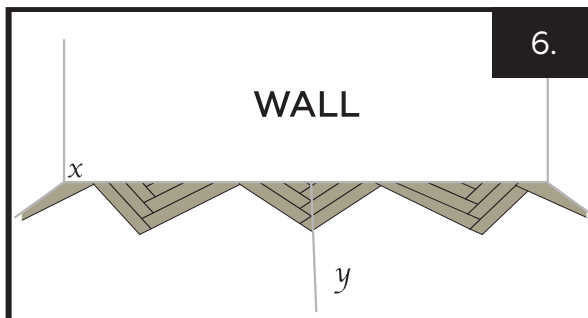
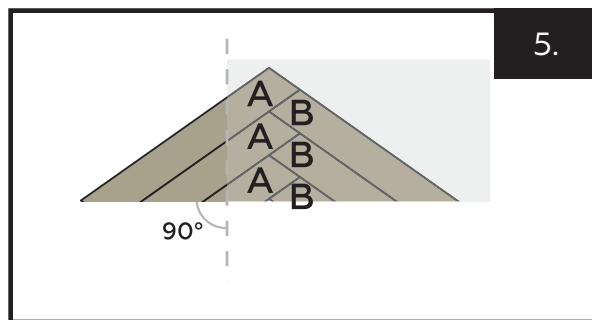
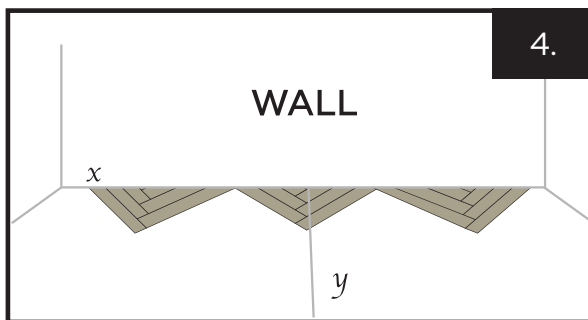
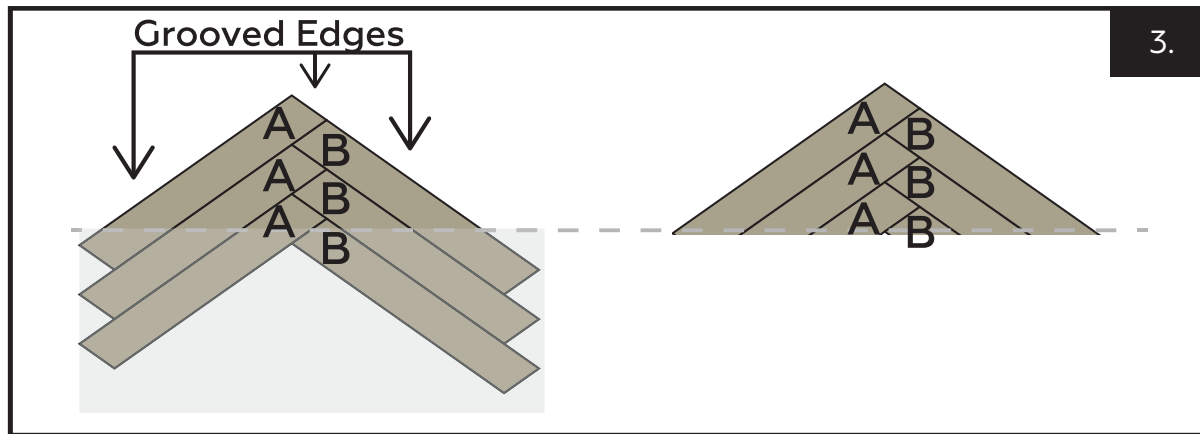
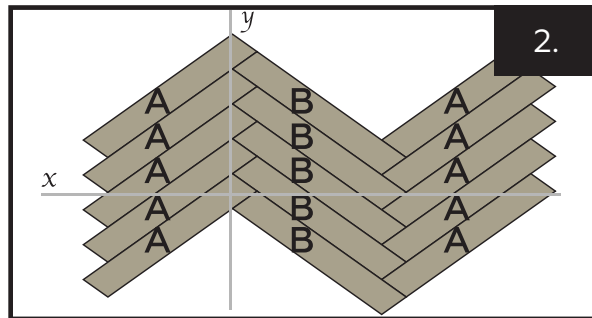
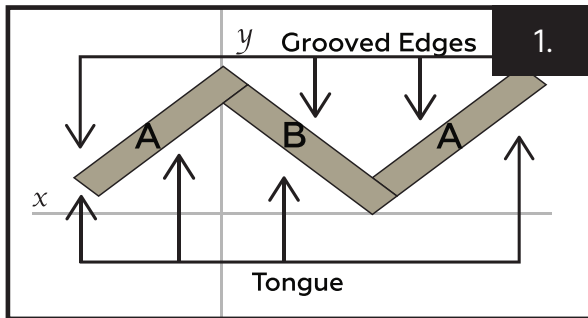



Product Description	Grade Levels	Installation Method
Rigid Luxury Vinyl Flooring	Above, On and Below	Click Lock

- When the new flooring meets a threshold or a doorway, we recommend undercutting the door jamb. To secure the right cut, turn a plank upside down and place it on the floor up to the door frame. Then place a reciprocating saw flat against the plank and simply cut through the frame. Remove the cut-out piece and vacuum away debris. Slide plank under pre-cut door frame. Door frame should be cut so that a 3/8" (9mm) gap is located from the edge of the plank under the casing to the wall.
- Tap the long side joint closed first, then tap the end joint closed.

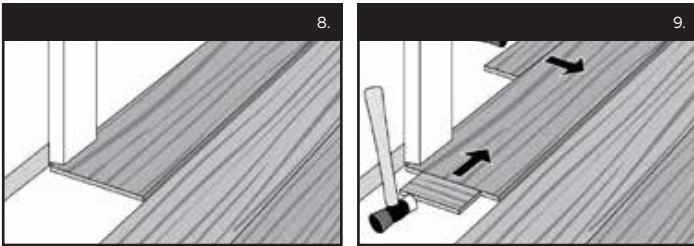

- In place of a resilient tile cutter, a miter or circular saw with the blade cutting into the design of the planks can be used to cut the rigid luxury vinyl floors. A utility knife can also be used, scoring the top of the pattern and snapping the plank. It will be necessary to cut the foam underlayment after snapping the plank.

NOTE: Maintain a 3/8" (9mm) expansion space around all walls and vertical objects. Quarter round or baseboard molding will cover this expansion space.

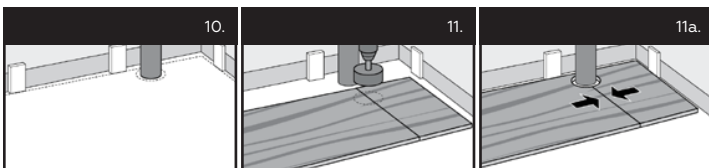

INSTALLING AROUND FIXED OBJECTS

- Allow 3/8" (9mm) expansion space around pipes or other fixed objects.
- In rows where there is a pipe, make sure the pipe falls exactly in line with the short side of two planks. Select a drill bit with the same diameter as the pipe plus 1/2" (13 mm). Click the planks together on the short side and drill a hole centered on the joint between the two planks. Then install the planks.
- For a double pipe, drill a hole equivalent to the diameter of the pipe plus 1/2" (13 mm) at each of the marked points. If located on the long side of the plank, make a 45° cut from each hole to the edge of the plank. Then, using an appropriate glue along the cut edges of the piece you cut out, glue the piece in place. Be sure no glue comes between the cut-out piece and the subfloor.
- Remove all spacers.
- Fill any expansion spaces around potentially wet areas, such as refrigerators, tubs, etc., with premium waterproof 100% silicone caulk.
- When installing LVF in any room or area larger than 100 lineal feet (30.5 m) in any direction, the use of a coordinating T-Molding/Reducer transition is required to separate the floor into sections no larger than 100' x 100' (30.5 m x 30.5 m) per section.
- Install moldings to cover the expansion gap. When installing moldings, never allow nails or screws to enter the LVF or the expansion zone around the flooring perimeter. All moldings and transition strips need to provide a 3/8" (9mm) expansion space as well.

NOTE: Maintain the 3/8" expansion gap around cabinets, pipes, toilet flanges and any obstacles in the floor (it is not recommended to trim around a toilet, however leave the expansion space around the toilet flange).

PROSERIES LUXURY VINYL FLOORING

INSTALLATION & CARE GUIDE

CLICK INSTALLATION



Product Description	Grade Levels	Installation Method
Rigid Luxury Vinyl Flooring	Above, On and Below	Click Lock

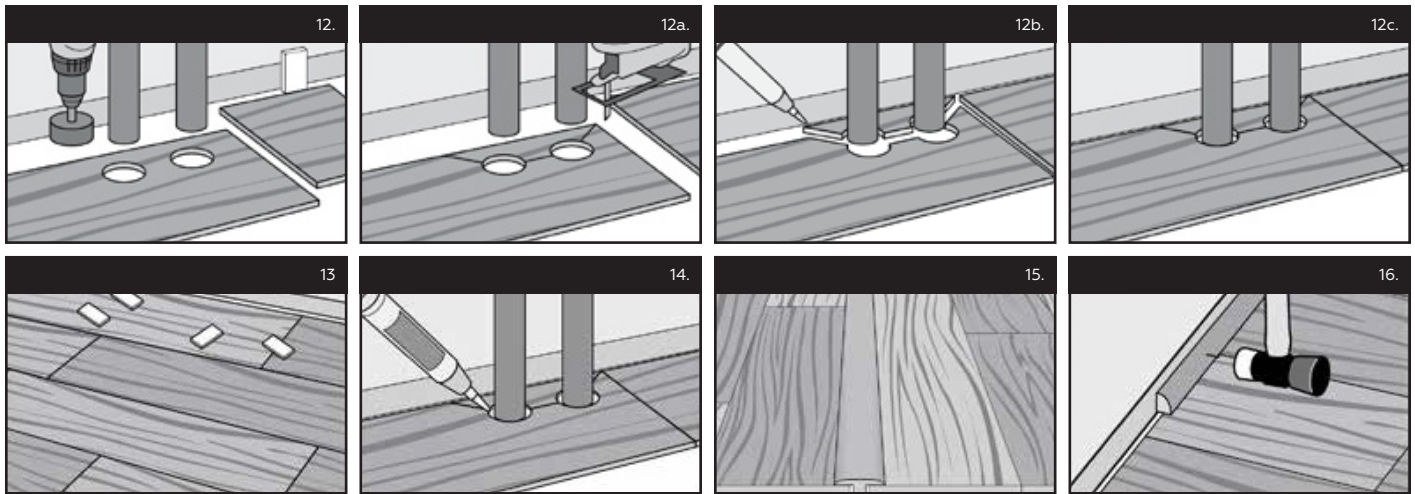

CARING & CLEANING

PREVENTATIVE MAINTENANCE

- Prevent indentations and scratches by using non-staining floor protectors on the legs of chairs, appliances and all heavy furniture. Floor protectors should be at least 1" in diameter. Periodically clean protectors to remove grit that may become embedded and cause scratching.
- Replace plastic or metal chair casters with rubber, and keep casters clean.
- Place walk-off mats at entrances. Mats should have a non-rubberized backing and be labeled as nonstaining.
- We recommend the use of a hard surface (non-studded), non-rubber chair mat to protect your floor from office chairs with casters. Light, rolling furniture should be outfitted with broad-surface, non-staining casters that have been engineered for hard surface floors. Such casters should be a minimum of 1" (2.5 cm) wide and at least 2" (5.1 cm) in diameter.
- Avoid exposure to direct sunlight for prolonged periods of time, as this can cause discoloration. Use of window coverings is recommended.
- Keep pets' nails trimmed.
- Remove shoes with cleats, spikes, or pointed high heels before walking on the floor.

- Protect your floors against burns. Burns from cigarettes, matches or other extremely hot items can cause permanent damage to your luxury vinyl flooring.

CLEANING

- Sweep the floor regularly with a soft bristle broom to remove loose dirt.
- Wash the floor with non-abrasive, neutral PH floor cleaner approved for vinyl floors.
- For every day cleaning, a mop moistened with warm water will suffice.
- Spills should be cleaned up immediately.

CLEANING AGENTS TO AVOID

- Detergent based cleaners
- Abrasive or mop and shine products
- Ammonia or bleaches
- Vacuum cleaner with a rotating beater bar engaged
- Floor wax

NOTE: Always read the cautionary information on all cleaners prior to use.

IMPORTANT: Never push, pull or drag furniture, appliances or other items across the floor. Always lift and carry furniture or heavy items.