



User Manual

## Modernist Pro Range

DOP48M86D\*\*/DOP36M86D\*\*

# Table of Contents

---

<b>Before You Begin</b>	<b>5</b>
Important	5
Energy-Saving Tips	5
Using the Water Reservoir	5
About the Oven Vent	7
<b>Regulatory Notice</b>	<b>8</b>
<b>Important Safety Instructions</b>	<b>9</b>
<b>Overview</b>	<b>15</b>
External Features	15
Control Panel (DOP48M86D**)	16
Control Panel (DOP36M86D**)	16
Display (DOP48M86D** Only)	17
Display (DOP36M86D** Only)	18
What is Included (DOP48M86D**)	19
What is Included (DOP36M86D**)	20
<b>Using the Cooktop</b>	<b>21</b>
About the Burners	21
About Cookware	23
Special Cooktop Features	24
About the Grates	24
About the Wok Ring	25
<b>Using the Basic Oven</b>	<b>26</b>
Basic Settings: Clock, Date & Time, Language	26
Using the Oven Racks	26
Using the Gliding Rack	27
Using the Temp Probe	29
About Oven Functions	30
Setting the Cooking Mode	33
Basic Baking and Broiling Instructions	34
Using the Kitchen Timer	34
Using Timed Cooking	37

# Table of Contents

---

Using Delay Start	38
Using the Cleaning Features	38
Using the Sabbath Feature	44
Using the Special Functions	45
Using Chef Mode	47
Using iQ Control	48
Starting the Oven Remotely	48
Using Control Lockout	49
Using Settings	49
Samsung SmartThings	52
<b>Using the Steam Oven</b>	<b>57</b>
Using the Oven Racks	57
About Oven Functions	57
Basic Baking and Broiling Instructions	60
Using the Special Functions	62
<b>Cooktop Maintenance</b>	<b>63</b>
Cleaning the Cooktop Surface	63
Cleaning Stainless-Steel Surfaces	63
Cleaning the Control Knobs	63
Disassembling/Assembling the Burners and Grates	64
About Burner Caps and Heads	64
About Burner Bases	64
About Electrodes	65
About the Grates and Wok Ring	65
Assembling the Burner Caps and Heads	65
<b>Oven Maintenance</b>	<b>68</b>
Oven Care and Cleaning	68
Removing/Re-installing the Oven Door	72
Changing the Oven Light	73
<b>Troubleshooting</b>	<b>75</b>
<b>Warranty and Service</b>	<b>78</b>
<b>Open-Source Announcement</b>	<b>80</b>



To Our Valued Customer:

Congratulations on your purchase of the very latest in Dacor® products! Our unique combination of features, style, and performance make us a great addition to your home.

To familiarize yourself with the controls, functions, and full potential of your new Dacor range, read this manual thoroughly, starting at the **Before You Begin** section (pg. 5).

Dacor appliances are designed and manufactured with quality and pride, while working within the framework of our company values. Should you ever have an issue with your range, first consult the **Troubleshooting** section (Pgs. 75 – 77), which gives suggestions and remedies that may pre-empt a call for service.

Valuable customer input helps us continually improve our products and services, so feel free to contact our Customer Assurance Team for assistance with all your product-support needs.

**Dacor Customer Assurance**

14425 Clark Avenue  
City of Industry, CA 91745

**Telephone:** 833-35-ELITE (833-353-5483) USA, Canada  
**Fax:** (626) 403-3130  
**Hours of Operation:** Mon – Fri, 5:00 a.m. to 5:00 p.m. Pacific Time  
**Website:** [www.dacor.com/customer-care/contact-us](http://www.dacor.com/customer-care/contact-us)

Thanks for choosing Dacor for your home. We are a company built by families for families, and we are dedicated to serving yours. We are confident that your new Dacor range will deliver a top-level performance and enjoyment for decades to come.

Sincerely,

*The Dacor Customer Assurance Team*

# Before You Begin

---

## Important Notes to the Owner

---

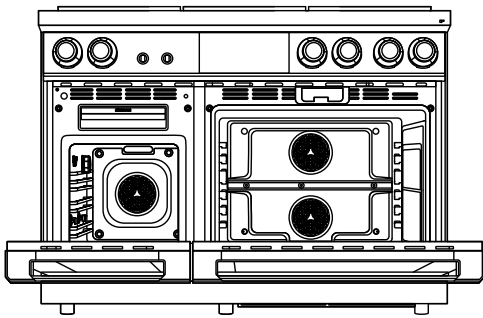

### Installer

- For best results, read this manual thoroughly before starting the installation.
- Leave this manual with the user.
- Write the range's model/serial numbers in this manual for service/maintenance use.

### User

- Keep this manual for personal/professional use.

Clean the oven fully before its first use. Then, ventilate the kitchen well, remove the accessories, and set the oven to Bake at 400 °F for 1 hour. There will be a distinct odor. This is normal.

## Energy-Saving Tips

---

- During cooking, the oven door should be closed except when you turn food. Leaving the door closed also maintains oven temperature, which saves energy.
- If cooking longer than 30 minutes, you can switch the oven off 5-10 minutes before the cooking is done. The residual heat finishes cooking the food.
- Plan oven use to avoid turning the oven off between cooking tasks.
- When possible, cook multiple items simultaneously.

## Using the Water Reservoir

---

This feature is used with steam functions: Steam Bake, Steam Roast, GreenClean™, Steam, etc. It is also used for removing water scale from the oven walls, especially after using steam functions. Fill it with water before use.

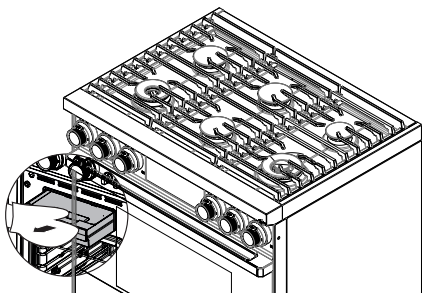

### NOTE

- The reservoir may be hot from oven use. If so, grasp the reservoir with an oven mitt.
- The reservoir can be fully removed from the range. Check the water level, and add water as needed. (You may add water without removing the reservoir completely.)

1. 36" range: the reservoir is on the upper right corner. To open this reservoir, on the control panel, press OPEN/CLOSE RESERVOIR. Pull out the partially ejected reservoir.
2. 48" range: the reservoir is on the top. To remove this reservoir, grasp the handle, and pull.

# Before You Begin

## Using the Water Reservoir, cont.

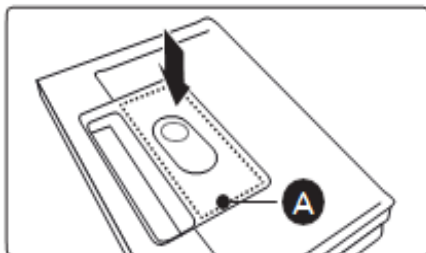
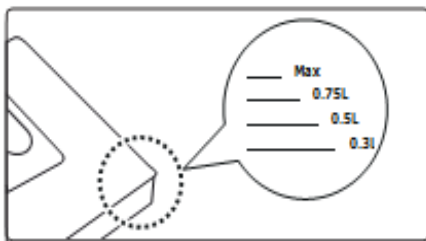
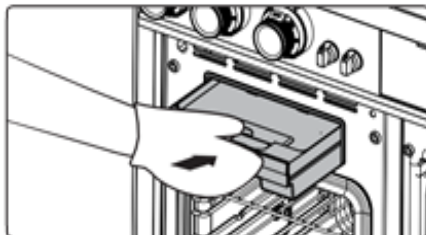
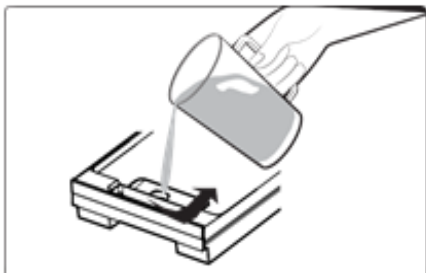

3. Open the reservoir cap, and then fill the reservoir with tap water.

### NOTE

You can open the reservoir by removing the rubber cap or by removing the clear plastic top. To avoid spilling water, filling water through the hole after removing rubber cap is recommended.

4. Replace the cap or the clear plastic.
5. 48" range: Pull the reservoir fully into the opening; 36" range: Slide the reservoir into its slot, and touch OPEN/CLOSE RESERVOIR.

### CAUTION

The reservoir and slot heat up during cooking. Wear oven mitts to handle the reservoir during and right after cooking.

6. Close the oven door.

### NOTE

Do not exceed the max line. Maximum reservoir capacity by model:

DOP48M86D\*\*: 1500 ml; DOP36M86D\*\*: 650 ml

### NOTE

Close the cap and upper portion of the water reservoir (labeled A) before using the oven.

# Before You Begin

---

## About the Oven Vent

---

The oven vent is under the oven door. Proper air circulation prevents burner combustion problems and ensures good performance. Do not block the vent or surrounding area. Be cautious near the vent. Steam can burn skin and melt certain items.

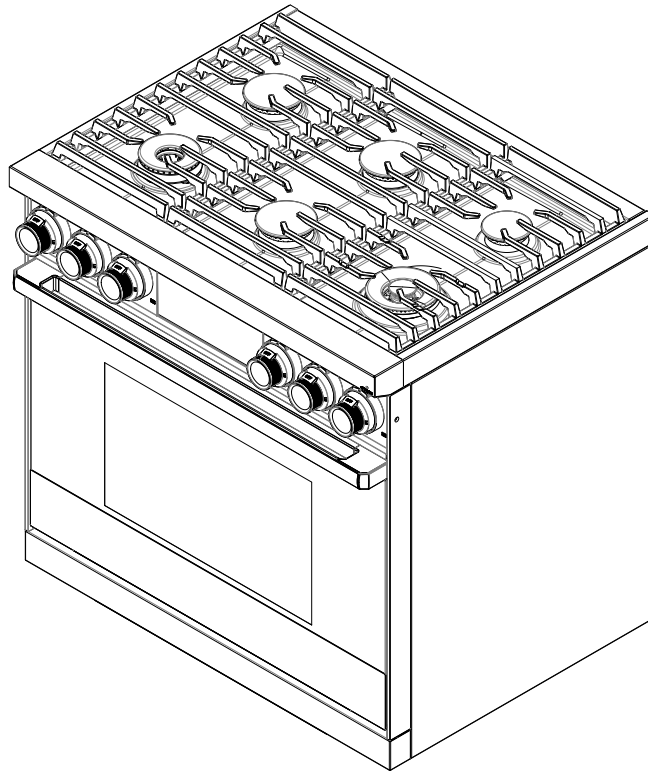

# Regulatory Notice

---

## 1. FCC (Federal Communications Commission) Notice

### CAUTION

Any modifications not expressly approved by the party responsible for compliance could void the user's authority to operate the equipment. This device complies with Part 15 of FCC Rules. Operation is subject to two conditions: 1) This device may not cause harmful interference; and 2) this device must accept any interference received, including that which causes undesired operation. For products available in the US/Canadian markets, only Channels 1 – 11 are available.

### FCC STATEMENT

This equipment was tested and found compliant within the limits for a Class B digital device, pursuant to Part 15 of FCC Rules. These limits are meant to reasonably protect against harmful interference in a residential installation. This equipment generates, uses, and can radiate radio-frequency energy, and, if not installed and used as instructed, may disrupt radio communications. However, interference may still occur in a given installation, which can be determined by turning the unit off and on. In case of disruption, the user should try to correct the interference by one or more of these measures:

- Reorienting or relocating the receiving antenna
- Increasing the separation between the equipment and receiver
- Connecting the equipment to an outlet on a different circuit than the radio/TV
- Consulting the dealer or an experienced radio/TV technician for help.

### FCC RADIATION-EXPOSURE STATEMENT

This equipment complies with FCC radiation-exposure limits set forth for an uncontrolled environment and should be installed/operated with at least 8" (20 cm) between the radiator and your body. This device and its antenna(s) must not be co-located or operated in conjunction with any other antenna or transmitter.

## 2. IC (Industry Canada) Notice

"IC" before the radio certification number signifies that Industry Canada technical specifications were met. Operation is subject to two conditions: 1) This device may not cause interference; and 2) this device must accept any interference received, including that which causes undesired operation. This Class B digital apparatus complies with Canadian ICES-003. For products available in the US/Canadian markets, only Channels 1 – 11 are available.

### IC RADIATION-EXPOSURE STATEMENT

The range complies with IC RSS-102 radiation-exposure limits set for an uncontrolled environment and should be installed/operated so there is at least 8" (20 cm) between the radiator and your body. This device and its antenna(s) must not be co-located or operated in conjunction with any other antenna or transmitter.

### General Safety Instructions

Testing found the range compliant with limits for a Class B digital device, pursuant to Part 18 of FCC rules. These limits are meant to reasonably protect against harmful interference in a home installation. The range generates, uses, and can radiate radio-frequency energy and, if not installed and used as directed, may harmfully impede radio communications; however, interference may still occur in a given installation. In case of disruption, which can be determined by turning the unit off and on, the user should try to correct the condition via one or more of these measures:

- Reorienting or relocating the receiving antenna
- Increasing the separation between the unit and receiver
- Connecting the equipment to an outlet on a different circuit than the radio/TV.



# Important Safety Instructions

---

## Read All Instructions Before Using This Appliance

---

- All electrical and gas equipment with moving parts can be dangerous. Read the Important Safety Information, and follow the instructions carefully to minimize risk of property damage, personal injury, and death.
- Keep this manual in a handy place for personal and professional reference.

## Symbols In This Manual

---

Follow these warning icons and symbols explicitly to prevent property damage and personal injury.

### **WARNING**

Hazards or unsafe practices that may result in severe personal injury or death.

### **CAUTION**

Hazards or unsafe practices that may result in electric shock, personal injury, or property damage.

### **NOTE**

Useful tips and instructions.

## State of California Proposition 65 Warning

---

This product contains chemicals known to the State of California to cause cancer and birth defects or other reproductive harm. Gas appliances can cause low-level exposure to Proposition 65 listed substances, (including benzene, carbon monoxide, formaldehyde, and soot) resulting from the incomplete combustion of LP or natural gas.

## Commonwealth of Massachusetts

---

This product must be installed by a licensed plumber or gas fitter qualified or licensed by the State of Massachusetts. When using ball-type gas shut-off valves, you must use the T-handle type.

Multiple flexible gas lines must not be connected in series.

# Important Safety Instructions

---

## General Safety

---

### WARNING

To reduce risk of property damage, fire, personal injury, and death:

- Do not touch any part of the range during or immediately after cooking.
- Learn where the gas-supply valve is and how to open/close it.
- When returning the range to its operating position, make sure it engages the anti-tip bracket.
- Do not leave children alone – Children should not be left alone or unattended in area where appliance is in use. They should never be allowed to sit or stand on any part of the appliance.
- Do not keep objects of interest to children on/above/around the range.
- Do not operate the range if it is damaged, if it malfunctions, or is missing parts.
- Do not heat unopened food containers – buildup of pressure may cause container to burst and result in injury.
- Do not use oven cleaners or liners in/around the oven.
- Use only dry pot holders – Moist or damp potholders on hot surfaces may result in burns from steam. Do not let potholder touch hot heating elements. Do not use a towel or other bulky cloth.
- Do not use the range to heat sealed containers.
- Do not repair/replace any part of the range except as instructed in this manual; all other service must be performed by a qualified technician.
- Do not strike the oven-door glass.
- In disposing of the range, remove the power cord and door to avoid a safety hazard.
- Cook meat to an internal temp of 160°F (71°C) and poultry to an internal temp of 180°F (82°C).
- Do not manually ignite the cooktop burners during a power outage.
- Keep combustible material (e.g., gasoline, alcohol, benzene) away from the range.
- An air curtain or range hood that blows air onto the range, shall not be used unless the hood and range comply with the Standard for Domestic Gas Ranges, ANSI Z21.1 • CSA1.1, and are listed by an independent testing lab for combination use.

## Fire Safety

---

### WARNING

To reduce risk of property damage, fire, personal injury, and death:

- Do not store/place/use combustible items (e.g., paper, plastic, fabrics, gasoline) near the range.
- Do not wear loose-fitting or hanging garments or accessories while using the range.
- Keep flammable items away from the cooktop burners.
- Regularly clean the oven vents.
- Do not use a towel or other bulky cloth as a pot holder.
- Do not douse a grease fire with water but turn off the burner, and if needed, use a multi-purpose, dry-chemical, or foam extinguisher.
- (Oven fires) Keep the door closed, and turn off the oven. Do not open the door until the fire is out. If needed, use a multipurpose, dry-chemical, or foam extinguisher.
- Do not heat sealed containers.

# Important Safety Instructions

---

## Gas Safety

---

### **WARNING**

If you smell gas:

- Close the range's gas-supply valve and evacuate the building
- Do not use a flame or sparking device (e.g., match, butane lighter or clicker, arc lighter)
- Do not turn on any gas or electric appliances
- Do not plug in a power cord or touch an electrical switch
- Do not use any phone in your building
- Immediately call your gas supplier from a neighbor's home, and follow the supplier's directions (if unable to reach the gas supplier, call the fire department).

### Checking For Gas Leaks

Do not use a flame to check for leaks. With a brush, spread a soap-and-water solution around the area in question. If there is a gas leak, small bubbles will appear in the solution. If unsure, call for professional help.

## Electrical and Grounding Safety

---

### **WARNING**

To reduce risk of property damage, fire, personal injury, and death:

- Plug the range into a grounded 3-prong outlet.
- Do not remove the ground prong.
- Do not use an adapter or an extension cord.
- Do not use a damaged plug, cord, or loose outlet or modify these components.
- Do not put a fuse in a neutral or ground circuit.
- Use a dedicated 240 Vac , 60 Hz, 50 Amp breaker for the 48" range and a 40 Amp breaker for the 36" range. A time-delay fuse or circuit breaker is recommended.
- Do not connect the ground wire to plastic plumbing lines, gas lines, or hot water pipes.
- The range must be grounded, which reduces risk of electric shock by giving the current a safe path. The range's cord has a grounding plug, which must be firmly plugged into an outlet that is properly installed and grounded per local regulations. If you are unsure your outlet is properly grounded, have a licensed electrician check it.
- Electrical service to the range must conform to local codes, in the absence of which, it should meet the latest ANSI/NFPA No. 70 – Latest Revision (for the U.S.) or the Canadian Electrical Code CSA C22.1 – Latest Revisions.
- The owner shall ensure provision of proper electrical service.

# Important Safety Instructions

---

## Installation Safety

---

### **WARNING**

To reduce risk of property damage, fire, personal injury, and death:

- Have the range installed and grounded by a qualified installer per the Installation Instructions.
- Do not service/modify/replace any parts unless as instructed in this manual. A qualified technician should perform all other service.
- Use only new, flexible connectors when installing the range.
- Ensure the anti-tip device is installed per the Installation Instructions.
- Use two or more people to move the range.
- After unpacking, remove all accessories from inside and around it. (Cautiously handle the heavy grate.)
- Check for parts that loosened during shipping.
- Have the range installed/adjusted by a qualified technician for the supplied gas type (natural or LP). For LP gas, the installer must replace every burner orifice with the provided LP orifice, and reverse the GPR adapter per manufacturer instructions and local regulations. The agency doing this work shall be responsible for the conversion.
- Installation must comply with local codes or, in their absence, with the National Fuel Gas Code, ANSI Z223.1/NFPA.54, latest edition. In Canada, installation must comply with the current Natural Gas Installation Code, CAN/CGA-B149.1, or the current Propane Installation Code, CAN/CGA-B149.2, and with local codes as applicable. This range was design-certified by ETL per ANSI Z21.1 (latest edition), and Canadian Gas Association per CAN/CGA-1.1 (latest edition).

## Location Safety

---

 **WARNING** property damage, fire, personal injury, and death:

- This range is for indoor, household use only, away from weather, water, strong drafts.
- The floor should be level and able to support the range's weight (about 564lbs for a 48" range). Synthetic flooring must withstand 180 °F (82 °C) without shrinking, warping, or discoloring. Over carpet, place a sheet of ¼-in. plywood or similar insulator.
- Do not hang long curtains or paper blinds on any window next to the range.
- Range vents must be unimpeded and sufficient airflow space provided all around the range.
- Wall coverings around the range must withstand heat up to 200 °F (93 °C).
- If overhead storage is needed, allow at least 30" (76.2 cm) between the cooking surface and the bottom of the cabinets, or install a range hood that projects at least 5" (12.7 cm) beyond the cabinetry face.

# Important Safety Instructions

---

## Cooktop Safety

---

### **WARNING**

To reduce risk of property damage, fire, personal injury, and death:

- Turn off all unused burners.
- Do not line any part of the range with aluminum foil.
- Do not leave burners unattended on medium or high heat settings.
- Before igniting, ensure all burner components are properly assembled.
- Use the LITE position to ignite a burner, and verify the burner ignites. If ignition fails, turn the knob to OFF, and wait for the gas to dissipate, then retry.
- When setting a burner to simmer, turn the knob slowly. Verify the burner stays lit.
- Place only cookware on the cooktop.
- The range is designed for use with a wok and wok ring.
- Always use a ventilation hood when cooking food.
- When done cooking, turn off the burner, and immediately remove the cookware.
- Before disassembling a burner, ensure the range is off and completely cool.
- After cleaning the burner spreader, dry it completely before re-assembly.
- When assembled, the burner-spreader spark mark should be next to the electrode.
- Do not pour water into the cooktop.
- Select cookware that is designed for cooktop use and fits the cooktop grates. Burner flames should remain beneath the cookware.
- Turn cookware handles away from the burners and front of the cooktop.
- Stand at a safe distance while frying.
- Heat frying oils slowly. If frying foods at high heat, monitor the entire process.
- If combining fats or oils when frying, mix them before heating.
- Use a deep-fry thermometer if possible to avoid overheating the oil.
- Use minimal oil when frying; let oil/fat cool before moving the cookware.
- Do not fry frozen or icy food.
- Let hot liquids sit at least 20 seconds after turning off the burner so the temperature of the liquid can stabilize. In case of scalding, immerse the scalded area in cool water at least 10 minutes, then cover with a clean, dry cloth; do not apply creams, oils, or lotions.
- Center pots on the grates. Cookware on rear burners should be max. 9" dia. Oversized cookware may impede air flow, causing the flame sputter and burn inefficiently.
- Do not wear loose or hanging garments when using the range.
- Always ensure the controls are OFF and the grates are cool before removing them.
- Stir sauces and similar liquids while warming.

# Important Safety Instructions

---

## Oven Safety

---

### WARNING

To reduce risk of property damage, fire, personal injury, and death:

- Use the oven for cooking only.
- Ensure oven racks are level.
- Do not remove or clean the door gasket.
- Do not spray water on hot oven-door glass.
- Do not line or cover any part of the range or oven chamber.
- Stand away if opening the door when the oven is on.
- Keep the oven free from grease buildup.
- Before repositioning the oven racks, ensure the oven is completely cool.
- Do not put plastic items in the oven.
- Always bake/roast with the oven door closed.
- Do not broil meat too close to the broil element.
- Trim excess fat from meat before cooking.
- When using cooking/roasting bags in the oven, follow the manufacturer's directions.

## Self-Cleaning Safety

---

### WARNING

To reduce risk of property damage, fire, personal injury, and death:

- The self-cleaning feature operates the oven at temperatures high enough to burn away oven residue. Do not touch the range, and keep children away from the range during self-cleaning.
- Before self-cleaning, remove all accessories from the oven. Only porcelain-coated oven racks may be left in the oven.
- Before self-cleaning, wipe food residue from the oven.
- When opening the door self-cleaning cycle, stand to the side.
- If the self-cleaning cycle malfunctions, turn off the oven and circuit breaker, and contact a qualified service technician.

# Overview

---

## External Features

---

### DOP48M86D\*\*

1. Spill tray
2. Surface burners
3. Removable oven door
4. Surface burner knobs (6)
5. Control panel

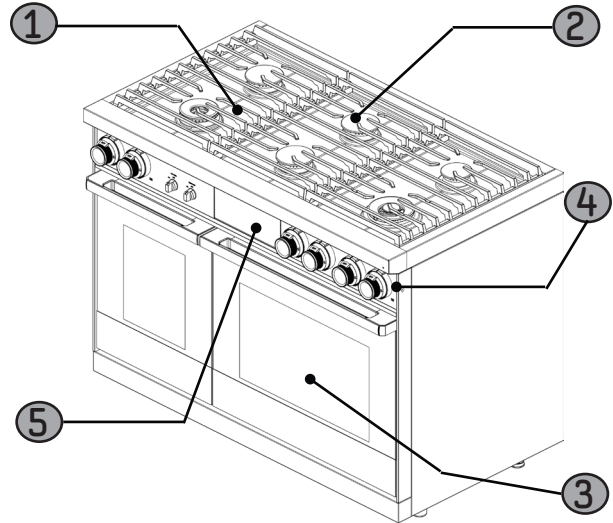

### DOP36M86D\*\*

1. Spill tray
2. Surface burners
3. Removable oven door
4. Surface burner knobs (6)
5. Control panel

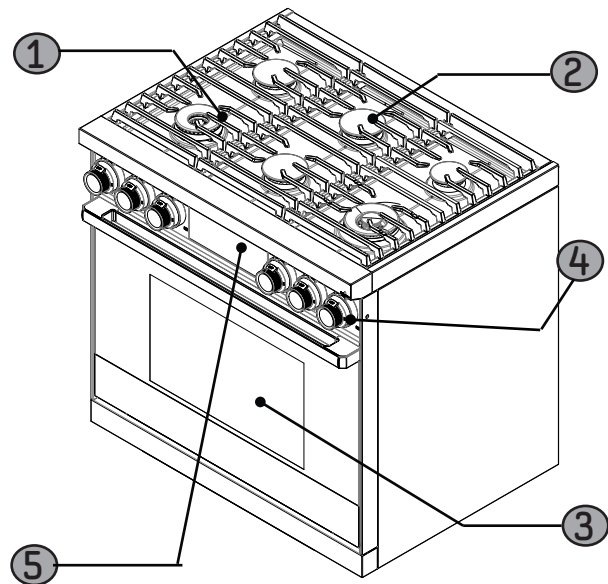

# Overview

## Control Panel (DOP48M86D\*\*)

Tap the display with clean, bare fingers. Oven mitts and wet or dirty fingers block the electronic transfer between finger and panel.

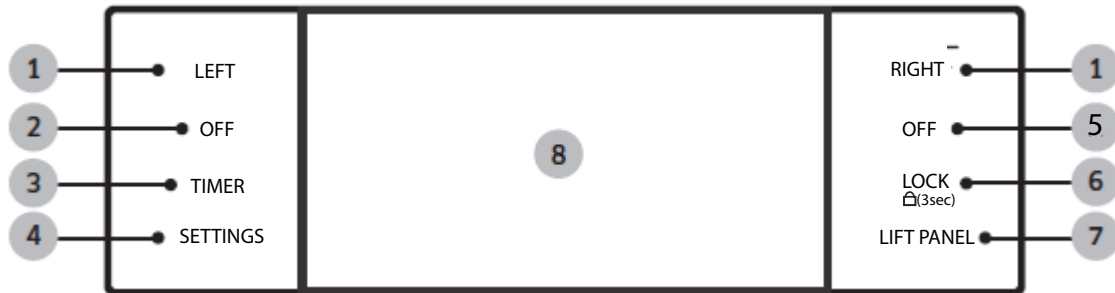

1. LEFT, RIGHT: Displays left/right oven mode. Shows status; does not turn ovens on/off.
2. OFF: Cancels cooking in left oven.
3. TIMER: Displays the Timer screen.
4. SETTINGS: Displays the Settings screen.
5. OFF: Cancels cooking in right oven.
6. LOCK: Press-hold for 3 seconds to disable all oven functions.
7. LIFT PANEL: Touch to tilt or flatten the panel.
8. Display: Swipe to navigate menus; tap to select a setting.

## Control Panel (DOP36M86D\*\*)

Tap the display with clean, bare fingers. Oven mitts and wet or dirty fingers block the electronic transfer between finger and panel.



1. TIMER: Displays the Timer screen.
2. LIGHT: Activates oven light.
3. OPEN/CLOSE RESERVOIR: Opens/closes the water reservoir.
4. OFF: Cancels the oven's cooking mode.
5. SETTINGS: Displays the Settings screen. Press-hold for 3 seconds to disable oven function.
6. LIFT PANEL: Touch to tilt or flatten the panel.
7. Display: Swipe to navigate menus; tap to select a setting.



# Overview

## Display (DOP48M86D\*\* Only)

The display shown is for reference only and may differ somewhat from the actual display.



### 1. Indicator area

- Timer (🕒): When set, the Timer indicator appears. If 3 or more timers are set, the number of set timers appears.
- Door lock (🔒): Appears when the oven door is locked.
- Wi-Fi (📶): Shows Wi-Fi signal strength in 4 levels. When Wi-Fi is disconnected, 🚫 appears.
- 12-hour energy saving (🌙): Appears if 12-hour energy saving is on.
- Current time: Shows the current time.

### 2. Page indicator: Shows the location (by page number) of the current mode.

### 3. Mode: The current/selected menu appears with a mode description.

### 4. Temperature: The current/selected temp appears; tap to display the Temp Adjustment screen.

### 5. Information area

- Temp Probe: The probe's set temperature appears; tap to show the Temp Probe screen.
- Cook Time: Shows the remaining cook time; tap to show the Cook Time screen.
- Delay Start: Shows the Delay Start time; tap to show the Delay Start screen.
- InstantHeat™: Shows that this feature is on/off; appears in Convection Bake or Convection Roast mode.
- Steam: Shows the steam level; tap to show the Steam Level screen; appears in Steam Bake and Steam Roast modes.

### 6. START: Tap to start the oven using the chosen setting.

### 7. View Summary: Tap to show cooking modes of left and right oven.

### 8. OVEN MODE: Tap to display mode select menu.

# Overview

## Display (DOP36M86D\*\* Only)

Tap the display with clean, bare fingers. Oven mitts and wet or dirty fingers block the electronic transfer between finger and panel.



### 1. Indicator area

- Timer (🕒): When set, the Timer indicator appears. If 3 or more timers are set, the number of set timers appears.
- Door lock (🔒): Appears when the oven door is locked.
- Wi-Fi (📶): Shows Wi-Fi signal strength in 4 levels.; when Wi-Fi is disconnected, ~~📶~~ appears.
- 12-hour energy saving (🔌): Appears if 12-hour energy saving is on.
- Current time: Shows the current time.

### 2. Page indicator: Shows the location (by page number) of the current mode.

### 3. Mode: The current/selected menu appears with a mode description.

### 4. Temperature: The current/selected temp appears; tap to show the Temp Adjustment screen.

### 5. Information area

- Temp Probe: The probe's set temperature appears; tap to show the Temp Probe screen.
- Cook Time: Shows the remaining cook time; tap to show the Cook Time screen.
- Delay Start: Shows Delay Start time; tap to show the Delay Start screen.
- InstantHeat™: Shows that this feature is on/off; appears in Convection Bake and Convection Roast modes.
- Steam: Shows the steam level; tap to show the Steam Level screen; appears in Steam Bake and Steam Roast modes.

### 6. START: Tap to start oven using displayed settings.

### 7. View Summary: Tap to show the cook mode.

### 8. OVEN MODE: Tap to show the mode's select menu.

# Overview

---

## What is Included (DOP48M86D\*\*)

---

\*The range comes with brass and porcelain burner caps to suit customer preference. (The brass caps will discolor with use; however, the discoloration does not affect the caps' intended function.)

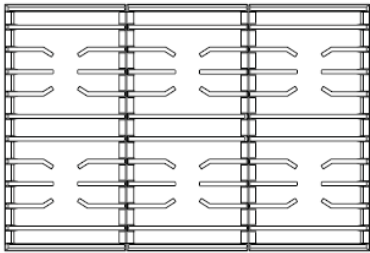

Grates (3)



Burner heads (6), caps (7)



Glide racks (2)

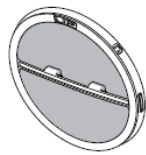

Convection filter (3)



Temp. Probe (2)

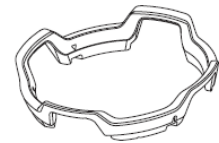

AMWR Wok ring (1)

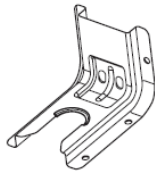

Anti-tip bracket (1)

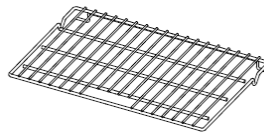

Wire rack (1)

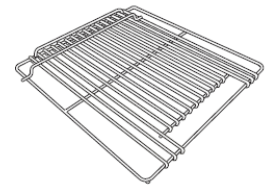

Small rack (1)

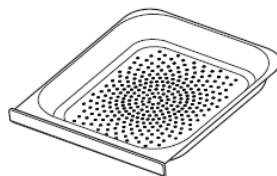

Steam tray (2)

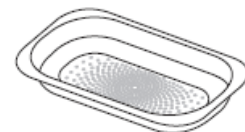

Half steam tray (2)

\*Steam oven only

# Overview

---

## What is Included (DOP36M86D\*\*)

---

\*The range comes with brass and porcelain burner caps to suit customer preference. (The brass caps will discolor with use; however, the discoloration does not affect the caps' intended function.)

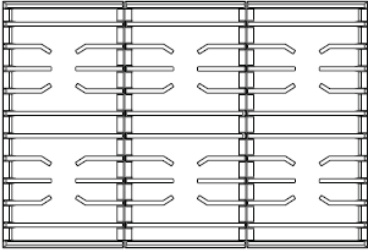

Grates (3)



Burner heads (6), caps (7)



Glide racks (2)

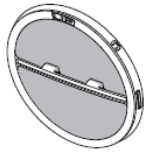

Convection filter (3)



Temp. Probe (2)

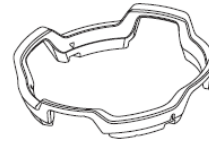

AMWR Wok ring (1)

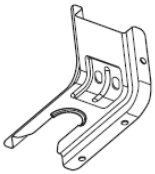

Anti-tip bracket (1)

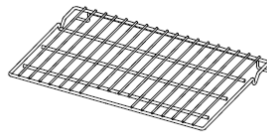

Wire rack (1)

# Using the Cooktop

## About the Burners

The graphic shows burner type and location. Burners spark when the knob is turned to the "flame symbol." When the burner ignites, sparking stops. Gaskets under the burners prevent spills from affecting internal parts.

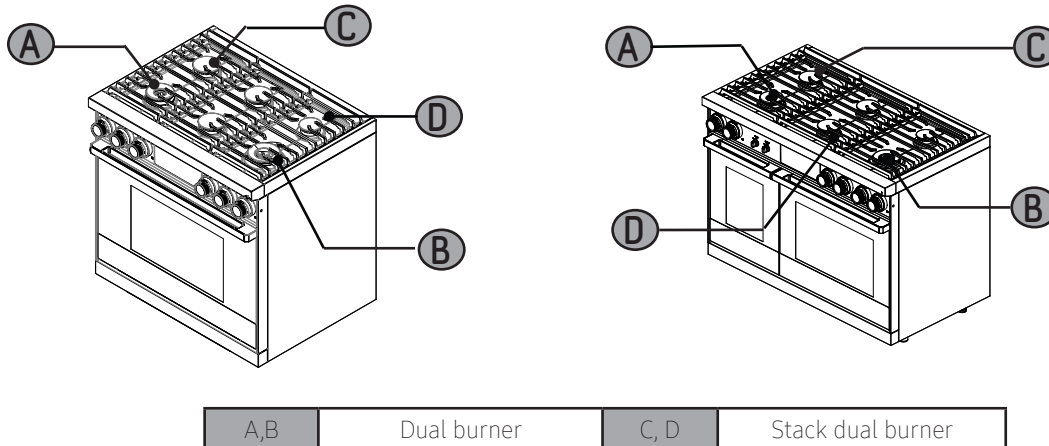

Each burner is designed for specific cooking purpose as below table.

Burner	Position	Purpose	Food type
Dual burner	Center Front (CF) <sup>1</sup>	Power heating/Low simmering	Boiling food, tomato sauce
	Right Front (RF) <sup>2</sup>		
	Left Front (LF)	Quick heating/Low simmering	General purpose cooking
Stack dual burner	Left Rear (LR), Right Front (RF) <sup>1</sup> Right Rear (RR) <sup>1</sup> Center Rear (CR) <sup>1</sup> Right Rear (RR) <sup>2</sup>	General heating/Low simmering	General food, casseroles

<sup>1</sup> 48" model; <sup>2</sup> 36" model.

# Using the Cooktop

---

## About Burner Ignition

---

Each knob has an associated burner, the location of which appears next to the knob.

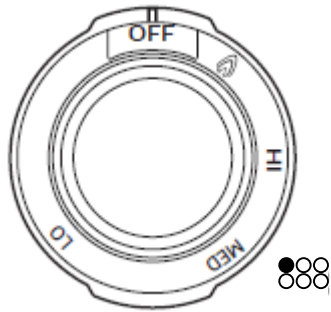

### To light a burner:

1. Push in the knob, and turn it counterclockwise to the flame symbol. The igniter sparks and clicks until the burner lights (about 4 seconds).
2. Place the cookware on the grate.
3. Adjust the flame as needed for proper cooking.

### NOTE

- The flame should burn evenly around the burner. A normal flame is steady and blue. Foreign matter in the gas line, especially in new construction, may cause an orange color that disappears with use. Yellow-tipped flames are normal for LP gas. If a burner does not ignite, or the igniter keeps sparking, or the flame is uneven, see **Troubleshooting**, Pg. 69.
- The igniter sparks if the flame is affected by a draft or home ventilation. Eliminate drafts, and reduce the ventilation blower speed to minimize this condition.
- If no spark is produced, verify that electricity is available. If there is a power failure, see **Manual Ignition** (below).
- Food cooks as quickly at a gentle boil as it does at a rolling boil, which wastes energy and cooks moisture, flavor, and nutrients out of food.
- Use a low/medium flame for cookware that conducts heat poorly (e.g., glass, ceramic, cast iron). Lower the flame until it covers about 1/3 of the cookware diameter to ensure even heating and minimize scorching.

### Manual Ignition

During a power failure, you can ignite the burner manually. Use caution when doing this.

1. Hold a long gas grill lighter to the surface burner you want to light.
2. Push in the control knob for that burner, and then turn it to the Lite position. Turn on the grill lighter to ignite the burner.
3. After the burner is lit, turn the control knob to adjust the flame level.

# Using the Cooktop

---

## About Cookware

---

### WARNING

- Cookware with rough bottoms can permanently damage the coated surfaces.
- To avoid burns and scalding, turn handles away from the front of the range and adjacent burners. Always center cookware on the grates for best balance.
- Always lift to reposition cookware. Do not drop cookware on a grate.
- To avoid burns or fire, keep the flame beneath the cookware.
- Verify that glass cookware is designed for cooktop use.
- Never leave plastic items on the cooktop or in front of the range. Flames or hot air in these areas can melt/ignite/explode such items.
- Hold a wok or small pot by its handle while cooking.

For overall safety and best performance, select cookware suitable for the task so food cooks evenly and efficiently.

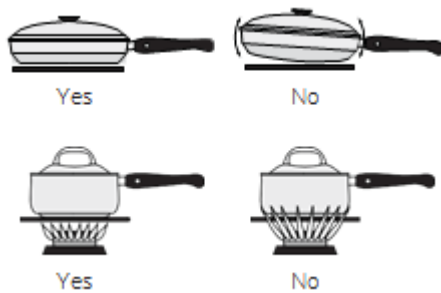

Use cookware that:

- has flat, smooth bottoms
- has tight-fitting lids to keep heat, odors, and steam in
- well-balanced with the handle weighing less than the main portion of the pot or pan.

# Using the Cooktop

## Special Cooktop Features

### Perma-Flame™

The Perma-Flame instant re-ignition feature automatically re-lights a burner quickly if it goes out. With Perma-Flame, your cooking experience is uninterrupted because the flame is re-ignited at the same level as when it went out.

### SimmerSear™

Dacor's exclusive precision burner control system. It allows you to cook with a wide range of heat settings, from simmer to sear.

## About the Grates

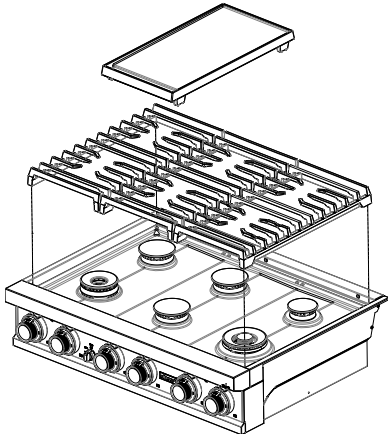

Check the underside of each grate for their proper position, then place the grates so their feet rest in the corresponding dimples. (Handle the heavy grates with care.)

### NOTE

AMG36/48 Griddle plate optional sold separately.

## About the Griddle

- Before using the griddle for the first time, wash it in hot, soapy water, then rinse, and let it dry fully.
  - For best results, preheat the griddle for 10 minutes.
  - Orient the griddle's grease trap at the rear of the cooktop.
1. With all burners off and the range cool to the touch, place the griddle and grate in the center of cooktop.
    - The specified burners are the same size, which ensures even cooking front and rear.
    - Fit the tabs on the bottom of the feet into the inside corners of the grate. Slight rocking is normal.

### Modernist Pro Range 48" model shown

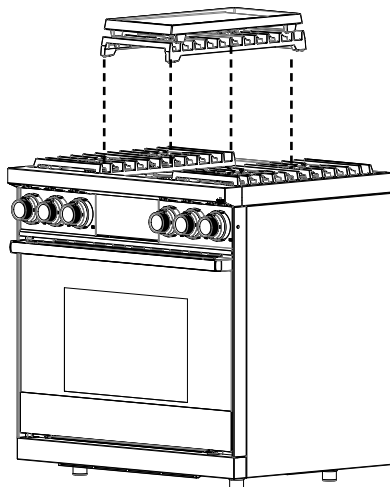

2. Push-turn the center-front burner knob to the Ignite (flame) setting. The burner ignites.

### NOTE

Refer to AMG48/36 manual for use and care instructions .

### CAUTION

Avoid using metal utensils on the surface because they can scratch the non-stick coating.

### NOTE

Clean the griddle after each use.



# Using the Cooktop

---

## CAUTION

- Do not remove the griddle until the range and all accessories are cool.
- The griddle may get hot when the range is on. Wear oven mitts to handle the griddle.
- Overheating and using metal utensils can damage the griddle coating.
- Use the griddle for cooking only.
- Do not cook excessively greasy foods. The grease may spill over.
- Use both hands to place/remove the heavy griddle.

## NOTE

- You may need to adjust heat settings for the griddle over time.
- The griddle may discolor as it becomes seasoned with use.
- If rust appears on the griddle, remove it as soon as possible.

## About the Wok Ring

---

Woks are often used for stir frying, pan frying, deep frying, and poaching. The provided Wok Ring supports 12" to 14" woks.

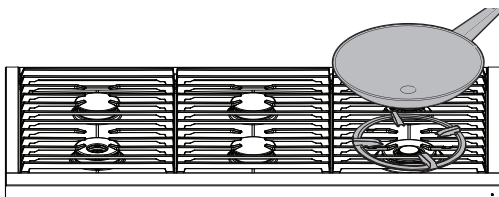

1. Turn off all burners, and let the grates cool fully.
2. Put the Wok Ring on the grate over the right front dual burner.
3. Set a wok on the Wok Ring.
4. Turn on the burner; adjust the flame as desired.

## CAUTION

- Do not remove the Wok Ring until all heated surfaces cool completely.
- Do not use flat-bottom cookware or that has a diameter under 12".
- Do not use an oversized wok. Burner flames may damage property and cause burns.
- Cook foods only under an active ventilation hood.

# Using the Basic Oven

## Basic Settings: Clock, Date&Time, Language

### Clock Theme

To change clock theme.

1. Tap **SETTINGS > Display**.
2. Tap **Clock theme**, swipe the display to view themes, and select a theme.

### Date & Time

To enable automatic date and time

1. Activate **Wi-Fi**.
2. Tap **SETTINGS > Date & Time > Automatic date and time**, and in the right-hand screen, tap **ON**. The date and time are set automatically.

To manually input date and time

1. Tap **SETTINGS > Date & Time > Automatic date and time**, and in the right-hand screen, tap **OFF**. Time zone, set date, and set time are activated.
2. Set the time zone, date, and time.

To change the time format

1. Tap **SETTINGS > Date & Time > Select time format**, and tap the right-hand screen.
2. Select 12-hour clock or 24-hour clock.

### Language

Choose a display language.

1. Tap **SETTINGS > Language**, and tap the right-hand screen.
2. Select **English, Spanish, or French**.

## Using the Oven Racks

### DOP36M86D\*\*, DOP48M86D\*\* (right oven)

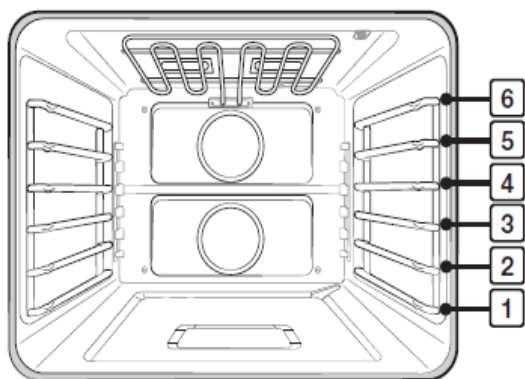

Type of Food	Level
Broiling hamburgers	6
Broil meat, small, cuts of poultry, fish	3-5
Bundt/pound cake, frozen pie, casserole	4 or 3
Angel-food cake, small roast	2
Turkey, large roast, ham, fresh pizza	1

# Using the Basic Oven

## Rack and Pan Placement

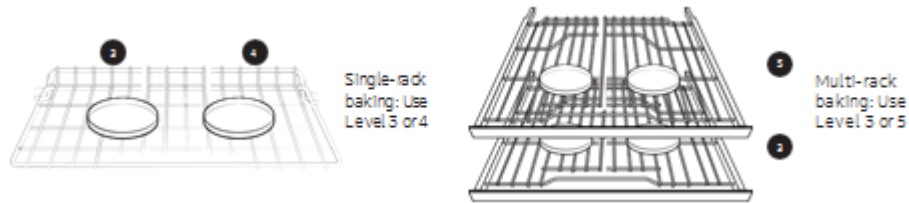

For best results, center pans in the oven as much as possible. If using multiple pans, each should have at least 1" of space around it.

## Before Using the Racks

Each rack has stops that must be placed correctly on the supports to keep the rack from accidentally being pulled completely out. (Adjust racks only when the oven is cool.)

## Removing the Racks

Pull the rack straight out until it stops, then tilt the rack up, and pull it out.

## Installing the Racks

Place the end of the rack on the support, then tilt the front up, and push the rack in.

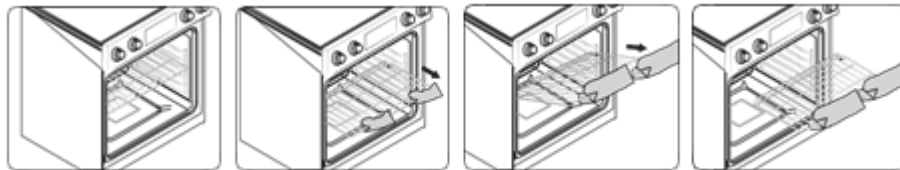

## Using the Gliding Rack

Two glide tracks let the rack extend fully out of the oven for easy removal and placement of cookware, especially heavier dishes.

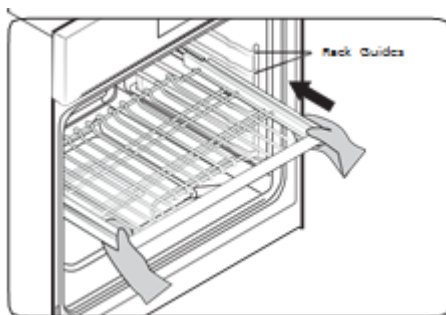

With the gliding rack slides retracted and the oven off, insert the rack between the guides until the rack reaches the back.

# Using the Basic Oven

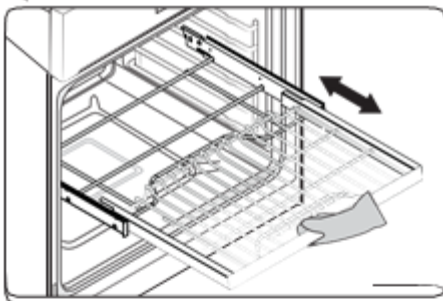

Grasp the handle to pull the gliding rack (left). Pulling by the frame may cause the rack to come off the guides, possibly harming the rack and the user. Wear oven mitts when handling the gliding rack during cooking.

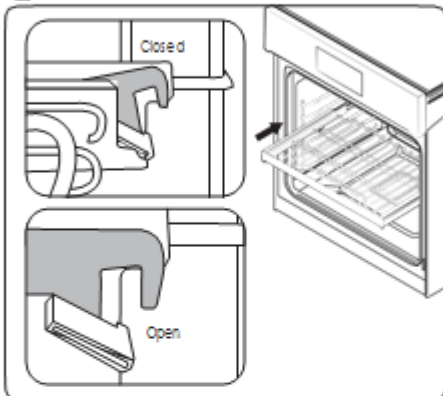

## NOTE

Lock the lower part of gliding rack on the oven wall during use to keep the rack securely on the guides. The hook on the gliding rack is controlled via the upper part of the rack. The closed hook tilts up. (See left.)

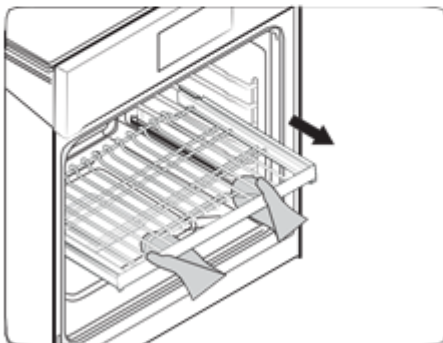

With the gliding rack closed, and the oven off and cool, grasp the rack, and frame and pull both forward to remove.



## CAUTION

Keep at least one open rack level between a gliding rack and a wire rack (see left).

## NOTE

You can install the gliding rack on any but the lowest rack level (available rack levels: 2-6).

# Using the Basic Oven

## Using the Temp Probe

For many foods, especially roasts and poultry, measuring the internal temperature is the best way to determine proper doneness. This feature lets you cook meat to an exact internal temperature. Use it with Bake, Convection Bake, Convection Roast, Pure Conv.Sear, or Dual Four-Part Pure Convection. Once the meat's internal temperature reaches 100 °F, the current temperature appears on the probe display.

1. Push the temp probe tip into the center of the meat.

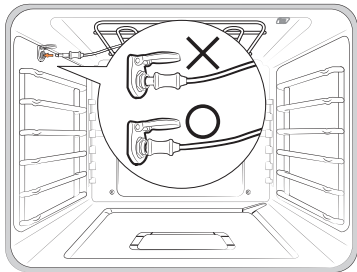
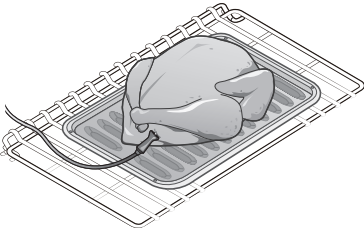
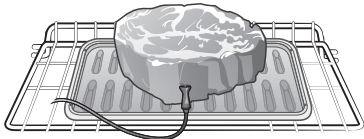

- Insert the probe as shown at left. Do not touch bone, fat, or gristle. If you do not fully insert the probe, it senses oven temp, not meat temp.
- Bone-in meat: Insert the probe in the center of the lowest, thickest portion.
- Whole poultry: Insert the probe in the thickest part of the inner thigh, parallel to the leg.
- If you activate Keep Warm to keep the meat warm after cooking it using the temp probe, the meat may cook beyond the desired temp.
- Temp probe socket location, by model: 48" range (left oven): left oven wall; (right oven): right oven wall; 36" range: left oven wall.

2. Insert the temp probe plug fully into the socket on the top side wall of the oven.
3. (48" range) Tap LEFT or RIGHT, and swipe to a cooking operation (Bake, Convection Bake, Convection Roast, Pure Conv.Sear, or Dual Four-Part Pure Convection). (36" range) Select a cooking mode, and set the cooking temperature. (See Pg. 33.)
4. Tap Temp Probe, and on the numeric pad, set an internal temp from 100 °F to 200 °F.
5. (Option) Set Cook Time/Delay Start.
6. Tap START. (When the set internal temp is reached, the probe turns off, and an alarm sounds.)

### NOTE

If you remove the temp probe without canceling the function or insert it without setting the function, cooking stops after 1 min.

# Using the Basic Oven

## Using the Temp Probe, cont.

### CAUTION

- To protect the probe tip, defrost food fully, and do not let the tip poke out of the meat.
- The probe should only be in the oven if the probe is in use.
- Do not use tongs to insert/remove the probe.
- Use the Temp probe only as instructed.

Type of Food		Internal temperature
Beef/Lamb	Rare	140 °F
	Medium	160 °F
	Well done	170 °F
Pork		
Poultry		180 - 185 °F

- If you cover the cooked meat with foil and let it sit 10 minutes, the internal temp rises 5-10 degrees. After cooking, remove the probe from the socket, then the meat

## About Oven Functions

Oven	Oven functions (*36" model only)
Basic oven	Bake, Convection Bake, Convection Roast, Broil, Pure Convection Sear, Convection Broil, Dual Four Part Pure Convection, Special Function, Chef Mode, Clean, Steam Bake*, Steam Roast*
Steam oven (48" only)	Bake, Convection Bake, Convection Roast, Broil, Convection Broil, 4 Part Pure Convection, Steam Bake, Steam Roast, Steam, Special Function, Special Steam Cook, Clean

### NOTE

For descriptions of steam oven functions in the 48" range, see the chart on Pg. 31.

## Cooking Mode

For 48" range, tap RIGHT, then swipe to select the cooking mode; for 36" product, select a cooking mode, then set a temperature. (See **Setting the Temperature**, Pg. 33 and **Basic Baking and Broiling Instructions**, Pg. 34.)

Mode	Temperature range	48" Model		36" Model	Temp probe	Instant-Heat™
		Left	Right			
Bake	175 °F (80 °C) - 550 °F (285 °C)	✓	✓	✓	✓	--
Convection Bake/Roast	175 °F (80 °C) - 550 °F (285 °C)	✓	✓	✓	✓	✓
Broil	LO / HI	✓	✓	✓	--	--
Pure Conv.Sear	175 °F (80 °C) - 475 °F (245 °C)	--	✓	✓	✓	--
Convection Broil	175 °F (80 °C) - 550 °F (285 °C)	✓	✓	✓	--	--
Steam Bake, Steam Roast	230 °F (110 °C) - 550 °F (285 °C)	✓	--	✓	✓	--
Dual 4-Part Pure Convection	175°F (80 °C) - 550 °F (285 °C)	✓	✓	✓	✓	--

# Using the Basic Oven

## About Oven Functions, cont.

Mode	Instruction
Bake	<ul style="list-style-type: none"> <li>• This mode is for baking cakes, cookies, casseroles. Always preheat the oven.</li> <li>• Baking temps/times vary with ingredients and size/shape of the baking pan.</li> <li>• Dark or nonstick coatings may cook faster with more browning.</li> <li>• Convection fan may turn on/off during baking.</li> </ul>
Convection Bake	<ul style="list-style-type: none"> <li>• This mode uses a fan to circulate oven heat evenly and continuously.</li> <li>• Better heat distribution allows even cooking and top results with multiple racks.</li> <li>• Breads/pastries brown more evenly.</li> <li>• Oven temp must be manually adjusted in 25 °F increments.</li> </ul>
Convection Roast	<ul style="list-style-type: none"> <li>• Good for cooking large tender cuts of meat uncovered; convection fan circulates heated air evenly all around the food.</li> <li>• Meat/poultry brown on all sides as if rotisserieed.</li> <li>• Heated air traps juices for moistness/tenderness while creating a golden-brown exterior.</li> </ul>
Broil	<ul style="list-style-type: none"> <li>• Cooks tender cuts of meat by direct heat under oven's broil element.</li> <li>• High heat cooks quickly for a rich, brown exterior; best for meat/fish/poultry up to 1" thick.</li> <li>• Always preheat the oven for 5 minutes.</li> <li>• See <b>Broiling Recommendation Guide</b>, Pg. 32.</li> </ul>
Pure Conv. Sear	Uses convection element and fan; oven cooks meat 75 °F (42 °C) higher than set temperature for first 15 min.; browning process sears meat exterior to trap natural juices; best for game hens, chickens, turkeys (stuffed or not), turkey breasts, pork tenderloin, pork loins.
Convection Broil	<ul style="list-style-type: none"> <li>• Similar to Broil but with the air circulated by the convection fan.</li> <li>• Broil element cycles on/off to maintain oven temp, while fan circulates hot air.</li> <li>• For thicker cuts of meat, fish, poultry; gently browns exterior and traps juices.</li> <li>• For best results, preheat broil element 5 minutes.</li> </ul>
Steam Bake	<ul style="list-style-type: none"> <li>• Ideal for bread, pastries, desserts; raises moisture for improved texture, flavor.</li> <li>• See <b>Steam Bake/Steam Roast Recommendation Guide</b>, pg. 32.</li> </ul>
Steam Roast	<ul style="list-style-type: none"> <li>• Ideal for roasted meat/poultry; maintains crispy surface while trapping juices for moistness/tenderness.</li> <li>• See <b>Steam Bake and Steam Roast Recommendation Guide</b>, pg. 32.</li> </ul>
Dual Four-Part Pure Convection	Uses convection element and fan to uniformly circulate air, allowing use of more oven space; good for single-/multi-rack baking, roasting, cooking full meals; food like pizza, cake, cookies, biscuits, frozen convenience foods can be cooked on 2 – 3 racks; also good for whole roasted duck, lamb shoulder, short leg of lamb.

# Using the Basic Oven

## About Oven Functions, cont.

### Broiling Recommendation Guide

The size, weight, thickness, starting temperature, and your doneness preference will affect broiling times. This guide is based on meats at refrigerator temperature. Always use a broiler pan and its grid when broiling. Always preheat the oven for 5 minutes.

Food	Doneness	Size	Thickness	Level	Rack position	Cooking time (min)	
						1st side	2nd side
Hamburgers	Medium	9 patties	¾"	Hi	6	3:00	2:00
	Medium	9 patties	1"	Hi	6	3:20	2:20
Beef steaks	Rare		1"	Hi	5	5:00	4:00
	Medium		1-1½"	Hi	5	6:00-6:30	4:30-4:00
	Well done		1-1½"	Lo	4	7:00-8:00	4:00-5:00
Chicken pieces	Well done	4.5 lbs.	½-¾"	Lo	3	16:00-18:00	13:00-15:00
	Well done	2 lbs.	½-¾"	Lo	3 or 4	15:00-16:00	10:00-12:00
Pork chops	Well done	1 lbs.	1"	Lo	3	8:00-10:00	6:00-8:00
Fish fillets	Well done		¼-½"	Lo	3 or 4	7:00-8:00	4:00-5:00

### Steam Bake/Steam Roast Recommendation Guide

Steam Mode	Level	Food
Steam Bake	High	Rye breads, Desserts (Flan caramel)
	Med	Croissants, Pies, Reheats (Pizza, Casseroles)
	Low	Pastries
Steam Roast	High	--
	Med	Meats, Poultry
	Low	Turkey, Large meats



# Using the Basic Oven

## Setting the Cooking Mode

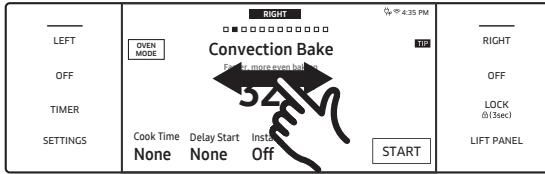

- Swipe the screen left/right to select a mode.

### NOTE

Control panel for 48" model shown. Operation is the same for 36" models.



- Tap the mode area to show the summarized mode.

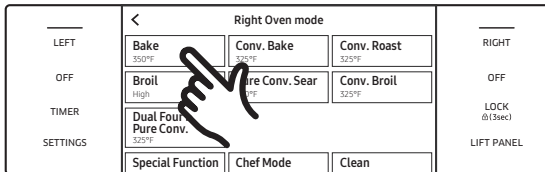

- Tap a mode.

## Setting the Cooking Temperature



- Tap the temperature to show the numeric pad.
- Tap the numeric pad to set the temperature.
- Tap **OK**.

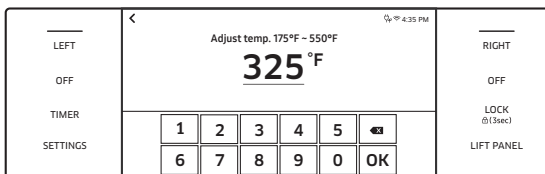

# Using the Basic Oven

## Basic Baking and Broiling Instructions



1. (48" range) Tap **RIGHT**, and swipe to select a cook mode (36" range) Select a cook mode.
2. Set a temperature. (See Pg. 33.)
  - Broil mode can be set only Hi or Lo.
  - Bread Proof temp's cannot be adjusted. This step shows how to use InstantHeat™, Steam
3. Bake, or Steam Roast. If not using these features, skip to Step 4. **InstantHeat™**
  - a. If you select Convection Bake or Convection Roast, the display shows InstantHeat™ info. (Default: OFF). Tap InstantHeat™ to activate the feature; the display shows ON.

### NOTE

- For best results, cook on one rack. (Baking on rack level 3 or 4; Roast on level 1 or 2.)
- When using InstantHeat™, do not preheat the oven.
- Preheat the oven if baking rising products (cakes, puff pastries).

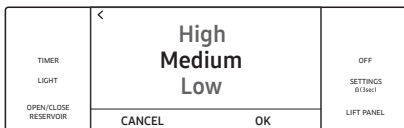

### Steam Bake/Steam Roast (36" range)

- a. Tap Oven Mode.
  - b. Tap **Steam Bake** or **Steam Roast**. (The display shows the steam-level info; default: Medium).
  - c. Tap the Steam area to view the steam level screen,
  - d. Set the level, and tap **OK**. (The steam level screen closes; the new level appears.) Fill the water reservoir before steam cooking. (See Pg. 5.)
4. If you want to use Cook Time or Delay Start, set the function now. (See Pgs. 37, 38 if needed.)

- Tap **START** to cook.
- Tap **OFF** when cooking is done or to cancel cooking.

### Steam Bake/Steam Roast (48" range)

- a. Tap left then tap Oven Mode to get Steam Bake or Steam Roast.

# Using the Basic Oven

## Basic Baking and Broiling Instructions, cont.

### Adjusting the Temperature While Cooking

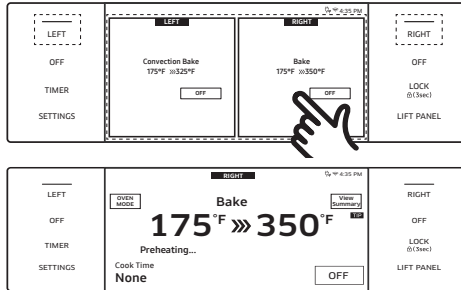

If using single mode, do one of these:

- Tap **RIGHT** (area or button), then tap the temperature area, and use the keypad to enter a new temperature.
- Place food in the preheated oven if the recipe calls for it. Preheating is crucial for good results if baking cakes, cookies, pastry, and breads. When the set temp is reached, the oven beeps 6 times.

- The convection oven fan shuts off when the oven door is opened.
- **DO NOT** leave the door open for long periods of time while using convection cooking or you may shorten the life of the convection heating element.

### **NOTE**

- If the door is open on an operating oven, cooking stops automatically after 2 minutes.
- When cooking is done, the cooling fan runs until the oven cools down.
- Drain residual water after steam cooking. Do not interrupt the draining process.
- After steam cooking, empty the reservoir so residual water does not affect other cook modes.
- The temperature on an oven thermometer may differ from the set oven temperature.
- The convection fan normally cycles on and off during cooking.

### **CAUTION**

Always broil with the oven door closed. Open the door carefully. Let hot air escape before removing food from or put food in the oven.

## Using the Kitchen Timer

This extra timer beeps when the set time elapses. It works with all oven modes but does not start or stop cooking functions.

### How to Set the Timer



1. Touch **TIMER**.

2. On the Timer screen, tap + **Add timer**.

# Using the Basic Oven

## Using the Kitchen Timer, cont.

### How to Set the Timer, cont.



3. Use the numeric pad to set the time from 1 sec to 23 hr, 59 min, 59 sec.

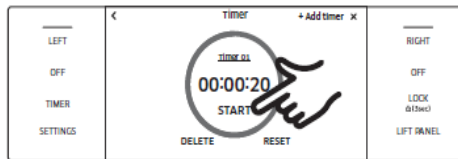

4. Tap **START**. When the set time elapses, the oven beeps; the display shows the Timer has finished.

- Pause/reset/delete the timer anytime by touching the screen.
- (48" range) The timer you set in the left oven can be used in the right oven, and vice versa.

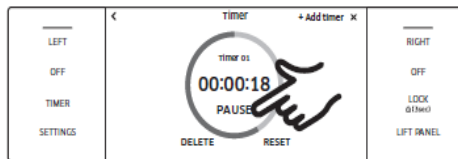

### Changing the Timer Name

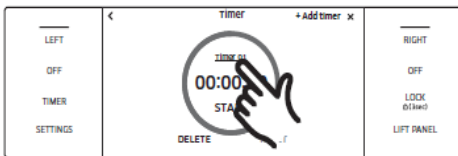

You can change the timer name to reflect the cooking task (e.g., Chicken).

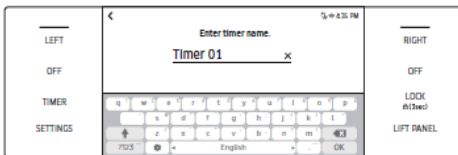

1. Tap the timer name area. (The keypad appears.)

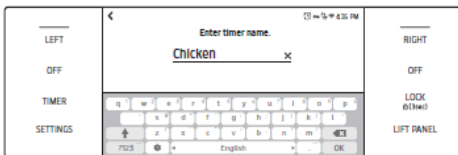

2. Use the keyboard to set the timer name. (The shows the new name.)

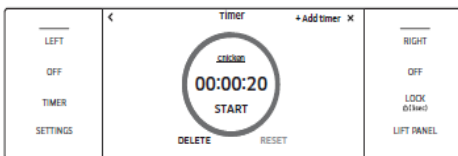

# Using the Basic Oven

## Using Timed Cooking

The oven turns on immediately, cooks for the set time period, then turns itself off when cooking is done. Timed Cooking only operates with another cooking operation (Bake, Convection Bake, Convection Roast, Pure Conv. Sear, Convection Broil, Steam Bake, Steam Roast, Dual Four-Part Pure Convection, Proof, Stone Mode, Dehydrate).

### NOTE

See Pgs. 30, 31 for the available modes for each oven.



1. (48" range) Tap **LEFT** or **RIGHT**, then swipe to a cooking operation. (36" range) Select a cooking mode.
2. Tap **Cook Time**. (The display changes to the cooking time screen.)
3. Tap numbers on the numeric pad to set the cooking time (from 1 min to 9 hrs 59 min's).
4. The cooking time appears in the screen's Cook Time area. (Cancel the set time anytime by setting it to 0 minutes.)

### NOTE

Control panel for 48" model shown. Operation is the same for 36" models.

### CAUTION

Use Timed Cooking and Delay Start to cook cured or frozen meats, and most fruits and vegetables. Foods that spoil easily (e.g., milk, eggs, fish, meat, poultry) should be chilled in the refrigerator first. Even chilled food should not sit in the oven over 1 hour before cooking starts and should be removed promptly when cooking is done.

# Using the Basic Oven

## Using Delay Start

In this mode, the oven timer turns the oven on according to the set time. You can have the oven turn itself off when a preset time elapses by setting Timed Cooking as well.

- Delay start can be used only with another cooking operation (Bake, Convection Bake, Convection Roast, Pure Conv.Sear, Steam Bake, Steam Roast, Dual Four Part Pure Convection, Proof, Stone Mode, Dehydrate, Self clean, GreenClean™).
- You can set the oven for a delay start before setting other cooking operations.
- The clock must be set to the current time.

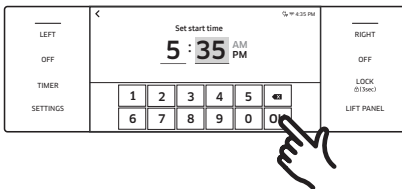
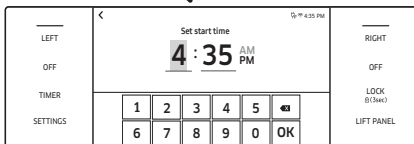

1. Adjust the rack(s) and place the food in the oven.
2. (48" range) Tap **LEFT** or **RIGHT**, then swipe to a cooking mode; (36" range) Select a cooking mode.
3. Set a cook time if you want the oven to turn itself off at a set time. (See **Using Timed Cooking**, Pg. 37).
4. Tap **Delay Start**. (The current time appears as the first entry.)
5. Use the numeric pad to set a cook start time. (The Delay Start screen closes; the start time, and, if set, the cook time, appear onscreen.)

## Using the Cleaning Features

The Clean feature has four selections: Self-Clean, GreenClean™, Descale, and Draining.

Feature	48" Pro Range		36" Pro Range
	Left	Right	
Self Clean	--	✓	✓
GreenClean™	✓	✓	✓
Descale	✓	--	✓
Draining	✓	--	✓

**Self clean (48" right oven, 36" oven)** Self-cleaning uses temperatures well above cooking temp's to burn off residual grease and food completely or reduce them to a fine ash you can wipe away with a damp cloth.

# Using the Basic Oven

## Using the Cleaning Features, cont.

### ⚠ CAUTION

- During self-cleaning, the outside of the oven become very hot. Do not leave children unattended near the appliance.
- Fumes emitted during self-cleaning are harmful to pet birds, which should be moved temporarily to separate, well-ventilated room.
- Do not line any part of the oven with aluminum foil. Doing so impedes heat circulation, causes poor results, and can permanently damage the oven interior.
- Do not force the oven door open during self-cleaning or you risk damaging the auto-locking system. Stand aside when opening the oven door after self-cleaning to let hot air escape.

### Self-Cleaning

This function heats the oven chamber to a very high temperature, incinerating residue to a fine ash that can be wiped up with a damp cloth.

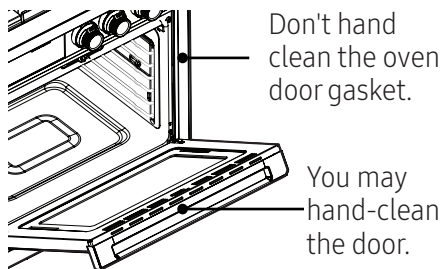

- Ventilate the kitchen well during self-cleaning.
- If you self-clean the chrome oven racks, they will darken, dull, and become hard to slide.
- Hand-clean residue on the oven's front frame and outside the door gasket with hot water, soap-filled steel-wool pads, or mild cleansers. Rinse with clean water and dry.
- Wipe debris from the oven floor.
- Ensure the oven light cover is in place and the light is off.

- Hand-clean residue on the oven's front frame and outside the door gasket with hot water, soap-filled steel-wool pads, or mild cleansers. Rinse with clean water and dry.
- Do not clean the gasket. Its fiberglass material cannot withstand abrasion. The gasket must remain intact. If it becomes worn, replace it.
- Dacor recommends self-cleaning only **once** per year. If additional cleaning is needed throughout the year, use the green-cleaning function. (See Pg. 41.)

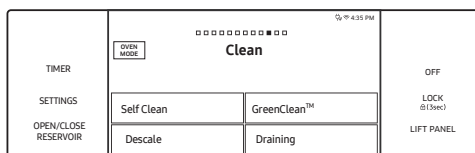

1. Remove racks, fan filter, and accessories from the oven.
2. Swipe the screen to **Clean**.
3. Tap **Self clean**.

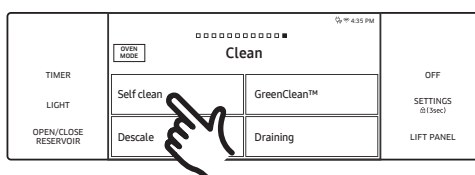

# Using the Basic Oven

## Using the Cleaning Features, cont.



4. Tap **Clean Time**

5. Tap the screen to set the clean time (2, 3, or 5 hrs (default: 3), and tap **OK**.

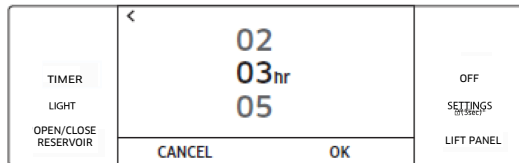

6. If not using Delay Start, go to Step 8. Otherwise, tap **Delay Start**, and go to Step 7.

7. Set the time you want self-cleaning to start, and tap **OK**.

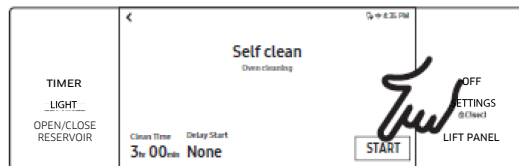

8. Tap **START** to begin self-cleaning. (Auto door lock engages; both doors lock when you run self-cleaning on either oven.)

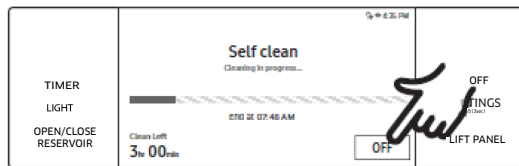

If you need to cancel self-cleaning, tap **OFF**.

### **NOTE**

- You cannot start self-cleaning if control lockout is active or if the oven is too hot.
- During self-cleaning, the oven doors lock automatically. The display shows the remaining cleaning time. The oven doors will not open until the oven has cooled fully.
- Self-cleaning can be used in only one oven at a time, and the idle oven cannot be used.
- Do not operate the cooktop during self-cleaning.

### **After a Self-Cleaning Cycle**

- Wipe up any ash with a damp cloth. (If white spots remain, remove them with a soap-filled steel-wool pad and rinse thoroughly with a vinegar and water mixture.)
- If the oven is not clean after one cycle, repeat the cycle.
- You cannot set the oven to cook until the door unlocks.



# Using the Basic Oven

## Using the Cleaning Features, cont.

### GreenClean™

This function saves time and energy by heating the oven chamber enough to loosen cooking residue so it can be wiped away with a damp cloth.

### ⚠ CAUTION

The oven door locks during GreenClean™. Forcing the door open can harm the auto-lock system.

### Before a GreenClean™ Cycle

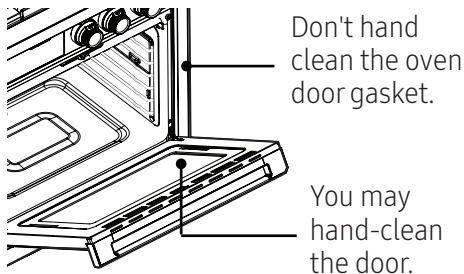

- Remove racks, rack supports, broil pan, broil pan insert, and all cookware.
  - The silver-colored oven racks can be Green-Cleaned, but they will darken and become harder to slide.
  - Do not clean the door gasket. Its material cannot withstand abrasion. The gasket must remain intact. If it becomes worn, have it replaced.
  - Ensure the oven light cover is in place and the oven light is off.
- Residue on the front frame of the oven and outside the door gasket needs to be hand cleaned with hot water, soap-filled steel-wool pads, or cleansers such as Soft Scrub. Rinse well with clean water and dry.

### Running a GreenClean™ Cycle

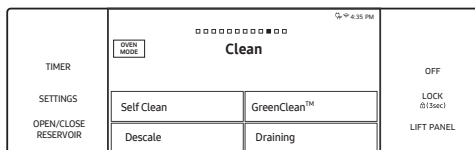

1. Swipe the screen to Clean.

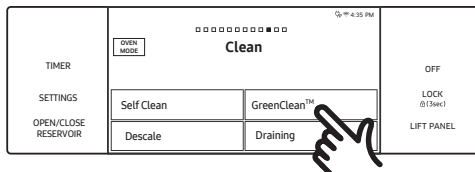

2. Tap **GreenClean™**.



3. Tap **START** to begin GreenClean™, and follow the on-screen instructions.



# Using the Basic Oven

## Using the Cleaning Features, cont.

### Running a GreenClean™ Cycle, cont.

#### NOTE

- (Basic oven) For best results, pour exactly 10 oz (300 ml) of water on the oven floor.
- (Steam oven) Operates with the steam function. Add 33.8 oz (1,000 ml) of water to the reservoir.
- You cannot start GreenClean™ if Control Lockout is active or until the oven cools.
- The oven doors lock automatically. The display shows the cleaning time remaining. You cannot open the oven doors or set the oven to cook until the oven has cooled.
- GreenClean™ can be used in only one oven at a time. While one oven is in GreenClean™ mode, you cannot use the other oven for cooking.

### After a GreenClean™ Cycle

- Stand aside and carefully open the oven door to let hot air escape safely; residual water on the oven floor is hot enough to burn.
- Immediately remove residual water with a sponge.
- With a detergent-soaked sponge or soft brush, wipe the oven interior. Remove stubborn residue with a nylon scourer and limescale with a vinegar-soaked cloth.
- If the oven remains dirty, you can repeat the procedure once the oven has cooled.
- After wiping the interior clean and dry, leave the oven door ajar so the interior enamel surface can dry thoroughly.

### Descale (steam oven)

If you use steam functions, you should descale regularly to remove minerals from the oven that may affect the taste or quality of your cooking. For a descaling cycle, use only descaling agents specific to steam ovens or coffee machines.

#### NOTE

If you use the steam functions for a specific time period, the Descale indicator turns on. You can use steam functions for a few hours without descaling; however, when those hours are exhausted, all steam functions are disabled until you run a descaling cycle.

DOP36M86D**	Operation hour		
	Pre alert	Cleaning alert	
	12	14	(+2)
DOP48M86D**	Operation hour		
WATER HARDNESS	Pre Alert	Cleaning alert	
Soft	39	42	(+3)
Medium	30	33	(+3)
Hard	23	26	(+3)

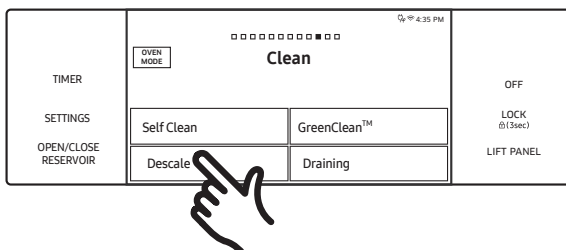

1. Swipe the screen to Clean.
2. Tap **Descale**.

# Using the Basic Oven

## Descal (steam oven), cont.



3. Tap **START**.

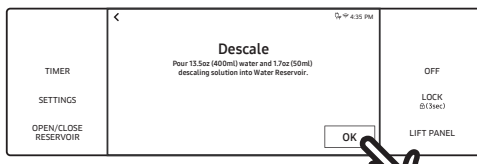

4. Follow the onscreen instructions. The cycle lasts 3 hours. Empty and clean the reservoir, then pour in water and descaling agent. (See the table for amounts.)

Required amount	Water		Descaling solution		Rinsing water	
	oz	ml	oz	ml	oz	ml
<b>36" Basic oven</b>	13.5	400	1.7	50	22.0	650
<b>18" Steam oven</b>	29.6	875	4.2	125	50.7	1500

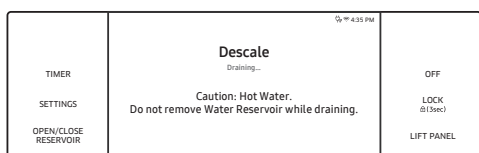

When descaling is done, the water drains automatically.

5. Use oven gloves to remove and empty the water reservoir and then refill it with tap water for rinsing. For rinsing, refer to the above table.

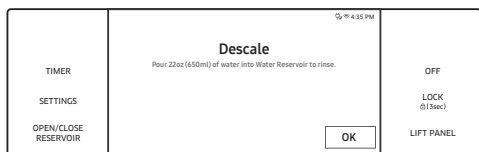

6. Follow the on-screen instructions and then tap **OK** to start rinsing.

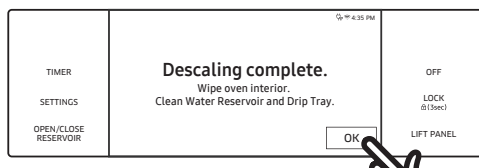

7. When rinsing is complete, use oven gloves to empty and clean the water reservoir.

### CAUTION

- While descaling, steam functions are disabled. If you cancel descaling, you must restart and complete the cycle within 3 hours to enable steam functions.
- To avoid accidents, keep children away from the oven.
- For the correct water-to-descaling agent ratio, use the manufacturer's directions. If the ratio is not 8 to 1, use the descaling agent's ratio.

### NOTE

Though the oven automatically starts descaling in 5 seconds without your confirmation, you should confirm your selection to keep descaling from starting by mistake.

# Using the Basic Oven

## Draining (48" oven only)

When a steam function is complete, you must drain the remaining water to prevent the water from affecting other cooking modes. To drain the water, follow these steps:

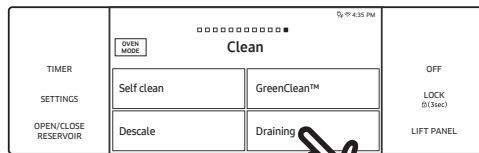

1. Swipe to the Clean screen and tap **Draining**.



2. Tap **START**. The oven drains water from the steam generator to the reservoir.

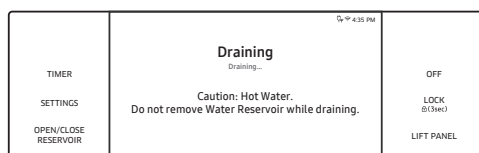

3. When draining is done, use oven mitts to remove and empty the reservoir.

## Using the Sabbath Feature

(For use on the Jewish Sabbath & Holidays)



For further assistance, guidelines on proper usage, and a complete list of models with the Sabbath feature, visit <http://www.star-k.org>.

You can use the Sabbath feature with baking only. You can adjust the oven temperature after you set the Sabbath feature. (Use oven-temp adjustment only during Jewish holidays.) The display, however, will not change and tones will not sound when a change occurs. Once the Sabbath feature is active and the oven properly set, the oven stays on until the Sabbath feature is cancelled. This overrides the factory preset 12-hr energy-saving feature. To use the oven light during the Sabbath, touch LIGHT before activating the Sabbath feature. Once the oven light is on and the Sabbath feature is active, the oven interior light stays on until the Sabbath feature is cancelled. If you will not use the oven light, turn it off before activating the Sabbath feature.



1. Swipe the screen to Bake mode.

2. Set the temperature and cook time you want.



3. Tap **START**.

# Using the Basic Oven

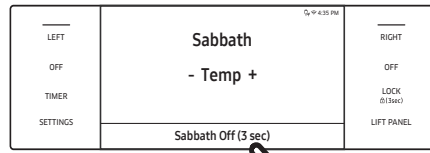
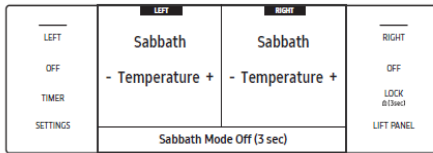
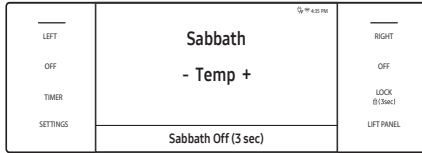
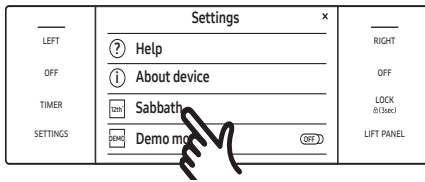

4. Tap **SETTINGS > Sabbath**, then tap **Sabbath** to start Sabbath mode. (The oven will not beep or show changes; you may change the oven temp once baking starts.)



To decrease the oven temp, tap "-" (see left); to increase the oven temp, tap "+." Each time you tap "-" or "+," oven temp changes 5°F.

5. Turn the oven off anytime by tapping **OFF**. (This does not cancel Sabbath mode.)
6. To turn Sabbath mode off, tap-hold **Sabbath Off** for 3 seconds.



After you change the oven temperature while the unit is in Sabbath mode, there is a 15 second delay before the unit recognizes the change.



You can set the Cook Time function before activating Sabbath mode.



If there is a power failure or interruption, the oven shuts off. When power returns, Sabbath appears on the control display, but the oven is disabled. Food may be removed from the oven; however, the oven cannot be turned on until after the Jewish Holidays,



To let the oven reach the set temperature, do not open the oven door or change the oven temp for about 30 minutes after starting Sabbath mode.

## Using the Special Functions

There are four specialized cooking options.

Mode	Temperature range	48" Pro Range Basic Oven	36" Pro Range
Keep Warm	**None	✓	✓
Proof	95 °F (35 °C) / 105 °F (40 °C)	✓	✓
Stone Bake Mode	175 °F (80 °C) - 550 °F (285 °C)	✓	✓
Dehydrate	105 °F (40 °C) - 225 °F (105 °C)	✓	✓

\*\*Non-adjustable. A factory-set temperature is applied for the best performance.

# Using the Basic Oven

## Using the Special Functions, cont..

Mode	Instruction									
Keep Warm	<ul style="list-style-type: none"> <li>Keeps cooked food warm for serving up to 3 hours after cooking is done.</li> <li>Use this mode by itself, or set it to activate after timed or delay timed cooking.</li> <li>Not for reheating food; 175 °F temperature is non-adjustable.</li> </ul>									
Proof	<ul style="list-style-type: none"> <li>Provides optimal temperature for dough proofing: 48" product left oven – 85°F / 95°F; 48" product right oven – 95°F / 105°F; 36" product – 95°F / 105°F</li> <li>For the best results, start Proof with a cool oven.</li> </ul>									
Stone Mode	<ul style="list-style-type: none"> <li>Stone accessory required.</li> <li>Bake on a baking or pizza stone for pizza and bread.</li> <li>For best results, preheat with a stone.</li> </ul>									
Dehydrate	<ul style="list-style-type: none"> <li>Removes moisture from food via heat circulation.</li> <li>Keep dehydrated food in a cool, dry place.</li> <li>Add lemon or pineapple juice, or sprinkle sugar on fruit to help retain sweetness.</li> <li>See the table below for Dehydrate settings.</li> </ul> <table border="1" data-bbox="367 955 1373 1083"> <thead> <tr> <th>Category</th> <th>Rack Level</th> <th>Temperature (°F)</th> </tr> </thead> <tbody> <tr> <td>Vegetables or Fruit</td> <td>3 or 4</td> <td>105-150</td> </tr> <tr> <td>Meat</td> <td>3 or 4</td> <td>145-225</td> </tr> </tbody> </table>	Category	Rack Level	Temperature (°F)	Vegetables or Fruit	3 or 4	105-150	Meat	3 or 4	145-225
Category	Rack Level	Temperature (°F)								
Vegetables or Fruit	3 or 4	105-150								
Meat	3 or 4	145-225								

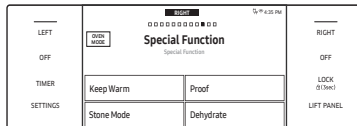

1. Swipe to the Special Function screen, and tap a cooking option.



2. Set the temperature, and tap **START**.



### ⚠ CAUTION

- If the oven temperature is above 125 °F, Proof will not work properly.
- Do not use Proof to warm food. The proofing temp cannot keep food warm.
- Place dough in a heat-safe bowl on rack level 3 or 4, and cover it with cloth or plastic wrap. (Anchor the plastic wrap beneath the bowl so the oven fan does not blow away the plastic wrap.)
- To avoid lowering the oven temp and prolonging proofing, leave the oven door closed.

### 📖 NOTE

- Preheating is unnecessary for special functions, except Stone Mode.
- An error beeps if the temperature is set out of range.

# Using the Basic Oven

## Using the Special Functions, cont.

Rack position chart for special cooking options

Mode	Rack Position
Keep Warm	5
Proof	3
Stone Mode	1 or 2
Dehydrate	3 or 4

Common features:

- Basic settings
- Using the temp probe
- Setting the mode
- Setting the temperature
- Kitchen timer
- Delay start
- Using the clean feature
- Using the Sabbath feature
- Using the iQ Control feature
- Control lockout
- Settings

## Using Chef Mode

Fifteen Chef Mode dishes simplify cooking for novice users, saving time or shortening the learning curve. Cook time and temperature are adjusted according to the selected recipe. You can download detailed recipes for each feature from the Dacor website.



1. Swipe to the Chef Mode screen.



2. Scroll and tap a Chef Mode dish.



3. Follow the on-screen instructions.

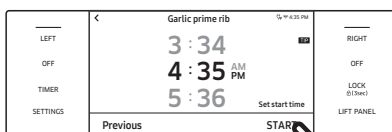

4. Tap **START** to start cooking.

# Using the Basic Oven

## Using Chef Mode, cont.

### Cooking Tips in Chef Mode



1. Tap **TIP** on the display.

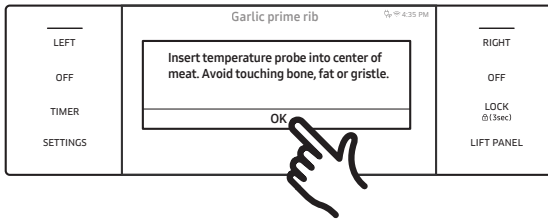

2. The tip appears with info relevant to the cooking task. When finished, tap **OK**.

## Using iQ Control

To use this feature, download the SmartThings app to a mobile device. Functions operated via SmartThings may not work will if communication conditions are poor or if the Wi-Fi signal is weak at the oven location. See the table for the main functions that can be operated from the app.

When iQ Control on the oven is off	Monitoring (Oven, Probe), Oven off
When iQ Control on the oven is on.	Monitoring (Oven, Probe), Oven start, Oven off, Error check

## Connecting the Oven

1. Download and open the Samsung SmartThings app on your smart device.
2. Follow the app's instructions to connect your oven.

The connected icon appears on the oven display, and the app confirms the connection. If the connection icon does not appear, follow the app's instructions to connect.

## Starting the Oven Remotely

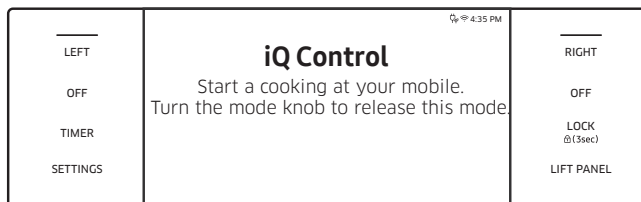

Tap **SETTINGS > Connections > iQ Control > ON** (for the appropriate oven).

When iQ Control is on you can remotely turn on/off the oven and change oven settings with your mobile device.

### **NOTE**

- Self-clean mode cannot be started remotely.
- Opening the oven door deactivates iQ Control, disabling remote operation.
- Even if iQ Control is deactivated, you can monitor oven status and turn the oven off.
- When oven cooking is finished or cancelled, iQ Control deactivates itself.



# Using the Basic Oven

## Using Control Lockout

This mode lets you disable touch pad functions. The oven doors also lock automatically. Control Lockout must be activated when the oven is in standby mode.

### Activating Control Lockout



1. Cancel or turn off all functions.
2. Touch-hold **LOCK** for 3 seconds.



The Control Lock screen appears.

### **NOTE**

Control Lockout is available only when the oven temperature is under 400 °F.

### Disabling Control Lockout

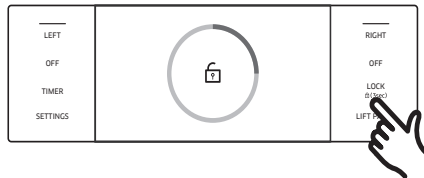

Touch-hold **LOCK** for 3 seconds.

The control lock confirmation and lock icon disappear.

## Using Settings

Change default settings to your preference or diagnose network-connection issues.



Tap **SETTINGS** to show the Settings screen.

### Wi-Fi

To enable a Wi-Fi connection:

1. Tap **SETTINGS > Connections > Wi-Fi**, then tap **ON** in the right screen. (To disable Wi-Fi, follow the same path, and tap OFF.)
2. Tap **Wi-Fi**, then tap a network in the list that appears.
3. When prompted, provide a password.

To manually input an IP address:

4. Tap **SETTINGS > Connections > Wi-Fi**, then tap **ON** in the right screen.
5. Tap **Wi-Fi > Add Network**.
6. Enter an IP manually, then tap **CONNECT** to apply your settings.

### **NOTE**

For details on the above features, see the Samsung SmartThings User Manual.

# Using the Basic Oven

---

## Using Settings, cont.

---

### Display

Brightness—You can change the brightness of the display screen.

- Tap **SETTINGS > Display > Brightness**, and use the adjacent bar to adjust screen brightness.

Screen Saver—If screen saver is off, the Clock theme and Timeout menu are disabled.

- Tap **SETTINGS > Display > Screen saver**, then tap OFF on the right screen.

Clock Theme

- Tap **SETTINGS > Display > Clock theme**, then tap the right screen, and select a theme.

Timeout

- Tap **SETTINGS > Display > Timeout**, then tap the right screen, and select a time (5 – 60 min.).

### Temp

Temp unit—You can program the oven control to display the temperature in Fahrenheit or Celsius. The oven has been preset at the factory to display in Fahrenheit.

- Tap **SETTINGS > Temp > Temp unit**, then tap the right screen, and select °C or °F.

Temp adjust—Oven temperature is factory calibrated. When first using the oven, follow recipe times and temperatures. If the oven cooks too hot/cool, you can recalibrate the oven temp. Before doing so, test a recipe by using a higher/lower temp than the recipe stipulates. The results will help you to decide the degree of adjustment. (Oven temp can be adjusted  $\pm 35$  °F ( $\pm 19$  °C). This adjustment will not affect broil or the self-clean temp's. The adjustment will be retained after a power failure.

- Tap **SETTINGS > Temp > Temperature Adjust**, then tap in the right screen, and adjust the temp.
- Temp can be increased/decreased by 35 °F (19 °C).

### Volume

Adjust the volume level for beeps and melodies.

- Tap **SETTINGS > Volume**, then use the adjacent bar to adjust the volume.

### Lighting

Dacor's Pro range has two distinctive lighting features: "Shower lighting" shines on knobs from above; "Welcome lighting" is an array that appears when you lift the LCD panel.

- To adjust Shower lighting, tap **SETTINGS > Lightings**, and select **On**, **Automatic**, or **Off**.
- To adjust Welcome lighting, tap **SETTINGS > Lightings**, and select **On** or **Off**.

### 12-hour Energy Saving

This feature turns the oven off after 12 hours of baking or 3 hours of broiling.

1. Tap **SETTINGS > 12 hour energy saving**, then tap ON on the right screen.
2. The 12-hour energy saving icon appears in the indicator area.

### Water Hardness (DOP48M86D\*\* only)

Adjust water hardness for the Steam oven. (The harder the water, the more you need to descale.)

- Tap **SETTINGS > Water hardness**, and select **Soft**, **Medium**, or **Hard**.

# Using the Basic Oven

---

## Using Settings, cont.

---

### iQ Control

To start the oven remotely.

- Tap **SETTINGS > Connections > iQ Control**, then tap **ON** on the appropriate oven. (See Using iQ Control, Pg. 49.)

### Easy Connection

Easily configure network settings, including the authentication procedure.

- Tap **SETTINGS > Connections > Easy connection**, then tap **CONNECT**.

### Hood Connectivity

By connecting to the hood, Hood is turned on/off automatically when you use the cooktop.

1. Tap **SETTINGS > Connections > Hood connectivity**.
2. Turn on Bluetooth on hood.
3. Tap **CONNECT** on LCD display to connect to the hood.

Hood-Control Range Model	Hood Model
DOP36M86D** DOP48M86D**	DHD30M967W, DHD36M967I, DHD36M987W, DHD48M967I, DHD48M987W

### Help

Help provides useful tips and explanations on a specific item that you select.

1. Troubleshooting
  - Tap a checkpoint directly on the screen, and try the suggestions.
2. Guide for first use
  - Provides simple instructions on the basic use of the oven.

### About Device

You can see information about the oven and do a software update. To update the software:

1. Tap **SETTINGS > About device > SW update**, and then tap **Update** in the right screen.
2. Tap **INSTALL**. The software is updated and the system restarts automatically.

### Sabbath

You can set Sabbath mode. See Using the Sabbath Feature, Pg. 44.

### Demo Mode

This mode is used retail display only. (The heating element does not operate.)

1. Tap **SETTINGS > Demo mode**, and then tap **ON** in the right screen.
2. The Demo mode indicator appears on screen.

### Remote Management

The call center will access your product remotely to check internal when you have some problems.

- Tap **SETTINGS > Connections > Remote management**, and then tap **ACTIVATE**.

# Using the Steam Oven

## Using the Oven Racks

### DOP48M86D\*\* Left Oven

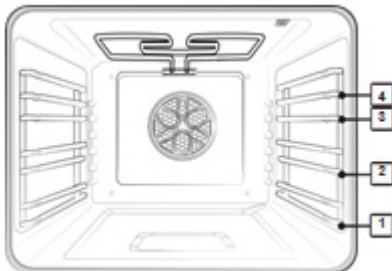

### Rack levels for certain cooking tasks (reference only)

Type of Food	Rack Level
Broiling hamburgers	4
Broiling meats or small cuts of poultry, fish	3-4
Bundt cakes, pound cakes, frozen pies, Angel food cakes, casseroles, small roasts	1-2
Large roasts, hams, fresh pizza	1

Each rack has stops that need to be placed correctly on the supports. These stops keep the rack from coming completely out.

1. Pull the rack straight out until it stops, then tilt up to release the catch, and pull the rack away from the oven.
2. Place the end of the rack on the support, tilt up to engage the catch, and push the rack in.

### **CAUTION**

- Do not cover any part of the oven with aluminum foil. Doing so hinders baking results and may harm the oven.
- Arrange racks only when the oven is cool.

## About Oven Functions

Oven	Oven Functions
Basic Oven	Bake, Convection Bake, Convection Roast, Broil, Pure Convection Sear, Convection Broil, Dual Four Part Pure Convection, Special Function, Chef Mode, Clean, Steam Bake*, Steam Roast* (*36" range only).
Steam Oven (48" only)	Bake, Convection Bake, Convection Roast, Broil, Convection Broil, 4 Part Pure Convection, Steam Bake, Steam Roast, Steam, Special Function, Special Steam Cook, Clean. (See Using the Steam Oven, starting Pg. 52.)

# Using the Steam Oven

## About Oven Functions, cont.

### Cooking Mode

Tap LEFT, swipe to select a cooking mode, and set a temperature. (See **Setting the Temperature**, pg. 33 and **Basic Baking and Broiling Instructions**, pg. 55.)

Mode	Temperature range	48" Model		36" Model	Temp probe	InstantHeat™
		Left	Right			
Bake	175 °F (80 °C) - 450 °F (230 °C)	✓	✓	✓	✓	--
Convection Bake/Roast	175 °F (80 °C) - 450 °F (230 °C)	✓	✓	✓	✓	✓
Broil	LO / HI	✓	✓	✓	--	--
Pure Conv.Sear	175 °F (80 °C) - 475 °F (245 °C)		✓	✓	✓	--
Convection Broil	175 °F (80 °C) - 450 °F (230 °C)	✓	✓	✓	--	--
Steam Bake/Roast	230 °F (110 °C) - 450 °F (230 °C)	✓	--	✓	--	--
4-Part Pure Convection	175 °F (80 °C) - 450 °F (230 °C)	✓	✓	✓	✓	--

### Cooking Mode with Steam Function (48" range)

On the display, tap LEFT, and select Steam or Special steam cook. Steam and Fine Steam temp's (215 °F/100 °C and 195 °F/90 °C respectively) are non-adjustable. For Guided Steam Cook and Steam Reheat, follow display directions. Be sure to fill the water reservoir. (See **Steam Bake/ Steam Roast Recommendation Guide**, this page.)

Mode	Instruction
Steam	A gentle cooking method using steam; steam vegetables, seafood, grain, eggs, and side dishes; suitable for all types of food, bottling, juicing, reheating.
Special steam cook	Consists of: Fine steam, Guided steam cook, Steam reheat.
Fine Steam	A very gentle cooking method suitable for seafood and chicken breast; food will be more tender and soft.
Guided steam cook	20 pre-programmed dishes are available in 5 categories: poultry and meat, fish, vegetables, eggs, and grain; cook time/temp are adjusted per the selected menu.
Steam Reheat	Heat with steam, then use convection or steam bake to finish; cook time/temp are adjusted per the selected menu; 10 pre-programmed dishes are available.

### Steam Bake/Steam Roast Recommendation Guide

Steam mode	Level	Foods
Steam Bake	High	Rye breads, Desserts (Flan caramel)
	Med	Croissants, Pies, Reheats (Pizza, Casseroles)
	Low	Pastries
Steam Roast	High	-
	Med	Meats, Poultry
	Low	Turkey, Large meats

# Using the Steam Oven

## About Oven Functions, cont.

### Recommended Cook Times for Steam Mode

#### 1. Vegetables

Put veggies in the perforated tray at rack Level 2 with the unperforated tray at Level 1 to catch drippings.

Food	Size	Cook time
Artichokes, red beets	Whole	30-35 min
Broccoli, Cauliflower	Florets	10-15 min
Cabbage	Shredded	25-35 min
Potatoes (unpeeled)	Medium	30-40 min
Potatoes (peeled)	Quartered	20-25 min
Peas	-	5-10 min
Green beans	-	15-20 min
Carrots	Sliced	10-20 min
Kohlrabi	Slices	15-20 min
Leeks	Slices	4-6 min
Green asparagus	Whole	8-10 min
White asparagus	Whole	10-15 min
Spinach	-	4-6 min
Brussels sprouts	Whole	20-25 min
Zucchini	Slices	2-3 min

#### 2. Meat, poultry, fish

Put food in the perforated tray at rack Level 2 with the unperforated tray at rack Level 1 to catch drippings.

Food	Size	Cook time
Pork chop	Sliced	15-25 min
Sausage	Whole	12-15 min
Chicken breast	.25 lbs	20-25 min
Fish fillet	.25 lbs	12-15 min
Whole fish	1 lb	20-25 min
Shellfish	-	10-15 min
Shrimp	-	8-10 min

Tip: Fine Steam is ideal for all seafood and chicken breasts, providing moist, tender results; the cooking method is same as Steam cooking but with a somewhat longer cook time.

#### 3. Grain and side dish

Add water as the recipe instructs.

Food	Size	Accessories	Cooking mode	Cook time
Long grain rice	1:2	Unperforated steam tray	Steam cook	20-30 min
Brown rice	1:2	Unperforated steam tray	Steam cook	30-40 min
Basmati rice	1:1.5	Unperforated steam tray	Steam cook	20-30 min
Parboiled rice	1:1.5	Unperforated steam tray	Steam cook	10-20 min
Couscous	1:1	Unperforated steam tray	Steam cook	5-10 min
Lentils	1:2	Unperforated steam tray	Steam cook	35-45 min
Dumplings	-	Perforated+Unperforated	Steam cook	20-25 min
Eggs (soft-boiled)	Large	Perforated steam tray	Steam cook	10-13 min
Eggs (hard boiled)	Large	Perforated steam tray	Steam cook	14-18 min

#### 4. Dessert, Compotes

Compotes use pear, berries, cherry, apple, plum, or rhubarb. Weigh the fruit, add 1/3 cup water, and add sugar and sugar and spices to taste.

Food	Size	Accessories	Cook mode	Cook time
Yeast dumplings	-	Perforated steam tray	Steam cook	20-25 min
Rice pudding	-	Perforated steam tray	Steam cook	25-35 min
Yogurt	-	Perforated steam tray	Proof 95 °F	5-6 hrs
Fruit compote*		Perforated steam tray	Steam cook	10-20 min

# Using the Steam Oven

## Basic Baking and Broiling Instructions

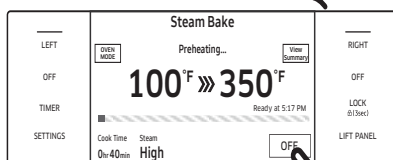
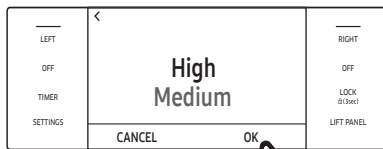
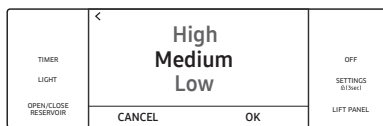

1. Tap **LEFT**, and swipe to select a cook mode.
2. Set the temperature. (See **Setting the Temperature**, pg. 33.)
  - **Broil mode** can be set only Hi or Lo.
  - **Keep Warm** and **Bread Proof** temperatures are unchangeable.
3. Follow the steps below to use InstantHeat™, Steam Bake, or Steam Roast. Otherwise, skip to Step 4.

### InstantHeat™

With Convection Bake or Convection Roast, the display shows the InstantHeat™ info (default: OFF). Tap the InstantHeat™ area; the display shows the feature is ON.

- When using InstantHeat™, place food in the oven before starting cooking.
- For best results, preheat the oven to bake "rising" foods.

### Steam Bake, Steam Roast

- a. If you select either of these modes, steam-level info appears onscreen (default: Medium).
- b. Tap the Steam area to view the steam level adjustment screen. Set the level to Low, Medium, or High.
- c. Tap **OK**. The steam level adjustment appears.

The new steam level appears on the main screen. Important: Fill the water reservoir before cooking. (See **Using the Water Reservoir**, Pg. 6.)

- If using Cook Time or Delay Start, set it now (see Pgs. 37, 38 for directions), and tap **START**.
- Tap **OFF** when cooking is done or to cancel cooking.

### **NOTE**

Control panel for 48" model shown. Operation is the same for 36" models.

# Using the Steam Oven

## Basic Baking and Broiling Instructions, cont.

### Broiling Recommendation Guide

The size, weight, thickness, start temperature, and your doneness preference affect broil times. This guide is based on meats at refrigerator temperature. Always use a broiler pan and its grid when broiling. Always preheat the oven for 5 minutes before broiling.

Food	Doneness	Size	Thickness	Level	Rack position	Cooking time (min)	
						1st side	2nd side
Hamburgers	Medium	6 patties	¾"	Hi	4	4:00-5:00	3:00-4:00
Beef steaks	Rare	-	1"	Hi	4	5:00-6:00	4:00-5:00
	Medium	-	1-1½"	Hi	4	6:00-7:00	5:00-6:00
Chicken pieces	Well done	2 lbs.	½-¾"	Lo	3	18:00-20:00	15:00-16:00
Pork chops	Well done	1 lbs.	1"	Lo	3	10:00-12:00	8:00-10:00
Fish fillets	Well done	-	¼-½"	Lo	3	8:00-9:00	5:00-6:00

### Adjusting the Oven Temperature While Cooking

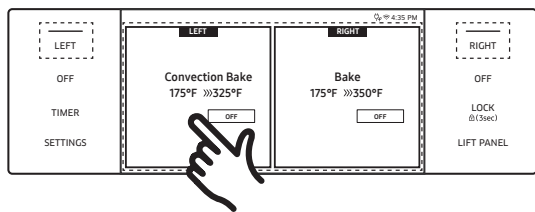

- If using the ovens in single mode, tap the LEFT or RIGHT area onscreen, then tap the temperature area, and use the number pad to enter a new temp.



### ⚠ CAUTION

When opening/closing the door, stand aside to let hot air or steam escape safely before you remove food from or put food into the oven.



Preheating is important for good results when baking cakes, cookies, pastry, and breads. When the set temperature is reached, the oven beeps 6 times.

- The convection oven fan shuts off when the oven door is opened.
- Leaving the door open during convection cooking may shorten the life of the convection heating element.

### 📄 NOTE

- If the door is left open longer than 2 minutes when cooking, all heating elements shut off.
- When finished cooking, the cooling fan runs until the oven has cooled down.
- Drain residual water after steam cooking. Do not interrupt the draining cycle.
- After steam cooking, empty the reservoir so residual water does not affect other cook modes.
- If using an oven thermometer, its reading may differ from your set oven temperature.
- The convection fan normally cycles on/off during cooking.
- The oven door must be closed during broiling.



# Using the Steam Oven

## Using the Special Functions

Special function provides 2 specialized cooking options.

Mode	Temperature range	48" Pro range Steam oven
Keep Warm	**None	✓
Proof	85 °F (29 °C) / 95 °F (35 °C)	✓

\*\* A non-adjustable, factory-set temperature is applied for best performance.

Mode	Instruction
Keep Warm	<ul style="list-style-type: none"> <li>Keeps cooked food at serving temp up to 3 hours after cooking is done.</li> <li>Use this mode individually or set it for timed or delay-timed cooking.</li> <li>Keep Warm temperature is not high enough to reheat cold food.</li> </ul>
Proof	<ul style="list-style-type: none"> <li>Provides optimal temperature for proofing bread dough.                             <ul style="list-style-type: none"> <li>48" range (left oven): 85°F / 95°F; (right oven): 95°F / 105°F</li> <li>36" range: 95°F / 105°F</li> </ul> </li> <li>For best results, start the Proof option with a cool oven.</li> </ul>

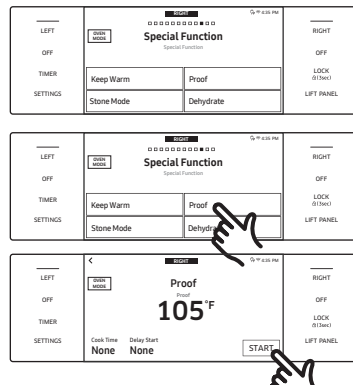

1. Swipe to the Special Function page.
2. Tap an option.
3. Set a temperature, and tap **START**.

### NOTE

Keep Warm mode's temp (175 °F) is non-adjustable.

### NOTE

- If the oven temperature is over 125 °F, Proof mode will not function properly.
- Do not use Proof for warming food. The temperature is insufficient to keep food warm.
- Place the dough in a heat-safe container on rack level 3 or 4, and cover it with a cloth or plastic wrap. (Ensure the oven fan cannot blow the plastic off.)
- To avoid prolonging proofing time, do not open the oven door.
- Of the four special functions, only Stone Mode requires preheating.
- An error beeps if the temperature is beyond the set range.
- For Keep Warm mode, use rack level 1 or 2; for Proof mode, use rack level 3 or 4.

# Cooktop Maintenance

---

Turn off power, and let all surfaces cool before cleaning the cooktop. Wear rubber gloves, and be mindful of sharp edges.

## Cleaning the Cooktop Surface

---

Clean up spills immediately.

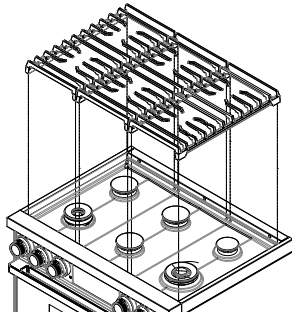

1. Turn off all burners.
2. When the grates have cooled, remove them.
3. Clean the cooktop surface with a soft cloth. If spills run into gaps in the burners, remove the burner caps and head, and wipe up the spills.
4. When finished, reassemble the burners, and reposition the grates.

## Cleaning Stainless-Steel Surfaces

---

Remove spills, spots, and grease stains with a soft, wet cloth.

1. Apply an approved stainless-steel cleanser to a cloth or paper towel.
2. Clean one small area then another, rubbing with the grain if applicable.
3. Dry the surface with a soft, dry cloth.

### CAUTION

- Do not use steel wool, sharp scrapers, or abrasive cleaners that can damage the range.
- Do not remove the cooktop basin. Gas lines can be damaged, perhaps causing a fire/malfunction.
- Do not pour water into the cooktop. The water could enter the mechanisms below, causing an electric-shock hazard or high levels of carbon monoxide from corroded gas valves/ports.
- Do not spray cleanser into the manifold holes. The ignition system inside them must remain dry.

## Cleaning the Control Knobs

---

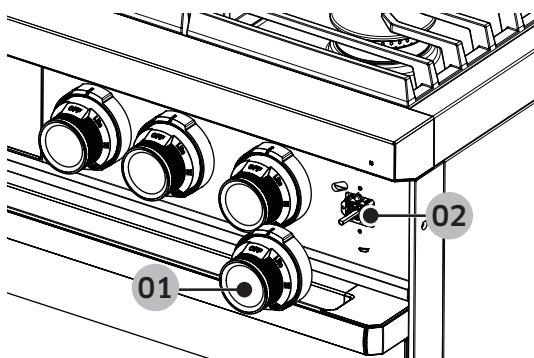

1. Grasp each knob and pull backward to remove.
2. Spill protector. Do not remove

1. Pull the knobs off their valve stems.
2. Clean the knobs in warm, soapy water (not the dishwasher), then rinse and dry them thoroughly.
3. Clean steel surfaces with stainless-steel cleaner.
4. Re-attach the knobs.

### CAUTION

Do not spray the control panel. The circuitry may be harmed and create an electric shock hazard.

# Cooktop Maintenance

## Disassembling/Assembling the Burners and Grates

Turn off burners, and wait for all surfaces to cool down.

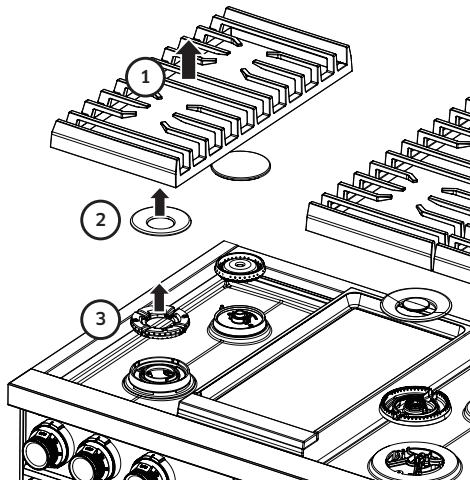

1. Remove the burner grates.
2. Remove the burner caps and heads.
3. Clean the grates and burner parts in warm, soapy water. (Do not use abrasive pads or cleaners.)
4. Rinse/dry grates and burner parts fully. (Ensure the burner ports are dry.)
5. Reassemble the burner heads, ensuring a starter electrode passes through the hole in each head (Pgs. 61).
6. Finish reassembly, ensuring each cap lies flat on each head.
7. Set the grates in their respective places.
8. Test all burners for proper function.

1. Grate
2. Cap
3. Head

## About Burner Caps and Heads

Wash the caps and heads in hot, soapy water, then rinse them under the tap. You may scour with a plastic scouring pad to remove burned-on residue. Use a sewing needle or twist tie to unclog the small holes in the burner head, if needed. After cleaning, return all burner caps and heads to their original positions.

### CAUTION

Burner parts are not dishwasher safe. Do not use steel wool or scouring powders to clean them.

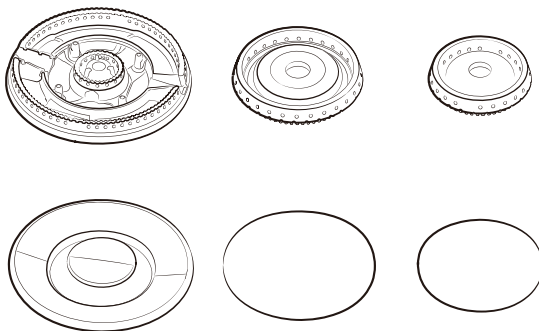

- The brass parts will discolor. However, this will not affect performance.
- After cleaning, check that all burner ports are unclogged.
- You may swap the original burner caps for porcelain caps.
- To remove burnt-on grease, soak the cap in a solution of 1 cup water and either 1 tbsp white vinegar or lemon juice. Do not clean with a metallic brush, which can damage the brass.

# Cooktop Maintenance

---

## About Burner Bases

---

### ⚠ CAUTION

- The burner bases are not removable.
- Allow no water in the burner bases and the brass gas orifices.
- Wipe them clean with a damp cloth, being careful not to damage the bases. Dry the bases completely before using the cooktop.

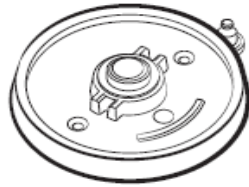
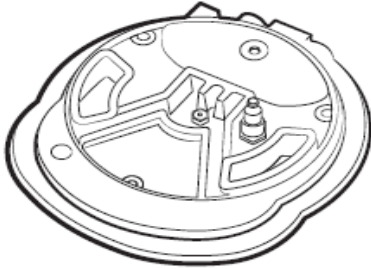

### ⚠ WARNING

## About Electrodes

---

Do not turn on the valve while touching the electrode; do not try to remove the electrode.

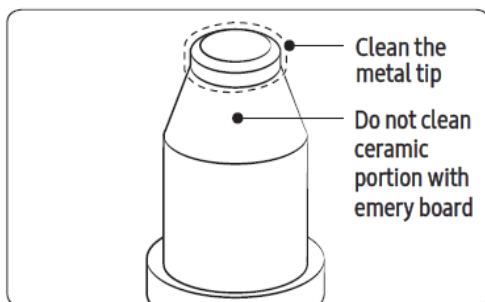

- Clean the electrode metal portion with a soft cloth.
- Clean/dry the white ceramic electrodes.
- Do not clean the igniters with water.
- Before reassembling the burners, push down gently on each electrode to verify it contacts the burner bases.

## About the Grates and Wok Ring

---

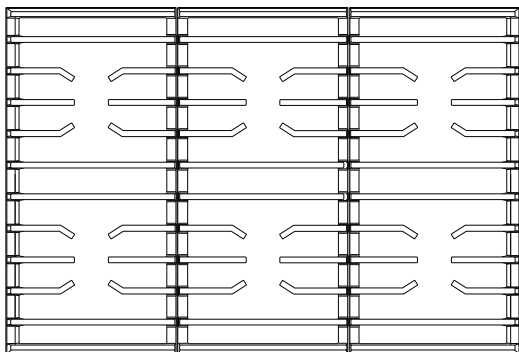

### ⚠ CAUTION

The grates are not dishwasher-safe. Wash them regularly and after spillovers. When the grates are safe to touch, remove and wash them in hot, soapy water, then rinse and dry them fully. Reposition the grates as instructed in this manual.

# Cooktop Maintenance

## Assembling the Burner Caps and Heads

### Dual-Burner Head/Caps

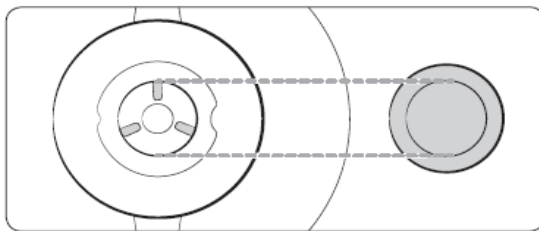
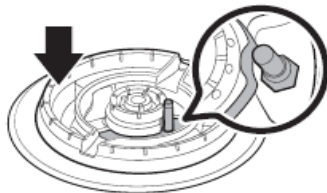
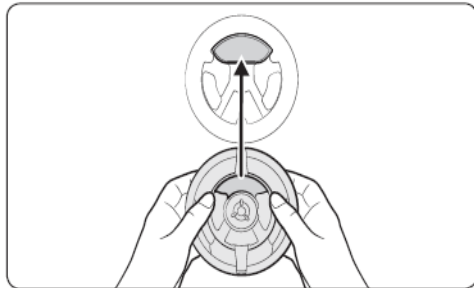

1. Orient the burner head so the electrode opening aligns with the electrode.
2. Install the burner head so the electrode passes through its hole in the head.  
(Ensure the burner head lies flat on the cooktop.)
3. Match the burner caps to the burners by size, then install the caps on the burner heads.

### **⚠ CAUTION**

Each cap fits a specific burner head. Verify that each cap is installed and lies flat on the correct head.

### Round Burner Head/Caps

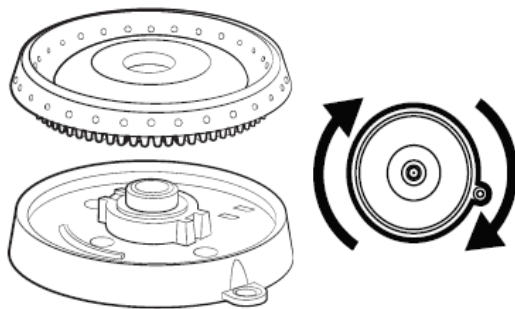

1. Put the burner heads on the burner bases as shown at left. (The bottom of the head fits inside the top of the base.)
2. Twist each head back and forth slightly until it drops into place.
3. Place the burner caps atop the burner rings. The ridge around the bottom of each cap fits around the top of the ring.

# Cooktop Maintenance

## Assembling the Burner Heads and Caps, cont.

### SimmerSear Burner Assembly

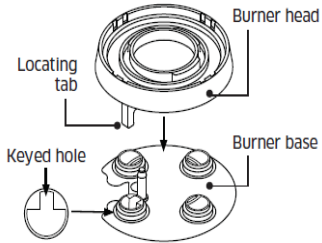

1. With power off and all surfaces cool, place the burner head so the locating tab goes into the keyed hole.

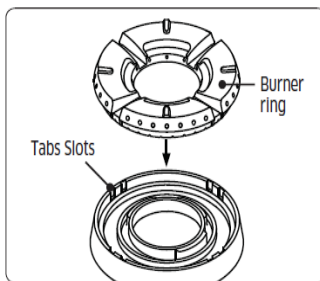

2. Put the burner rings on the burner heads. Match the tabs on the ring bottom to the slots on the head. Twist each ring back and forth slightly until it drops into place.

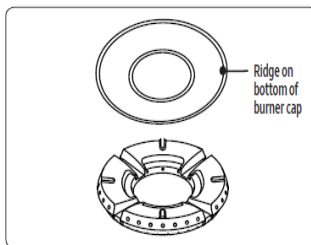

3. Put the burner caps on the burner rings. The ridge around the bottom edge of the cap fits around the top of the ring.

After assembling the burners, test for proper function. Improper assembled parts will cause poor ignition or uneven flames (see below). If the flame is excessively yellow, shut off the burner immediately and let it cool. Adjust the burner caps, and relight the burner. A good flame is blue and even all around the burner.

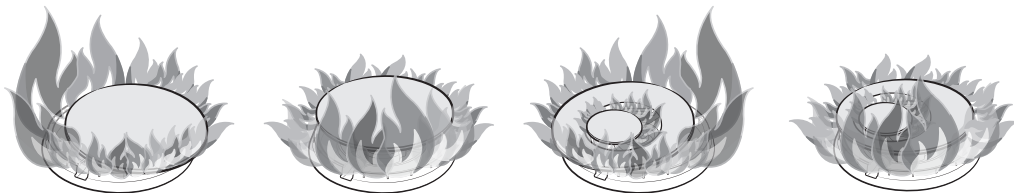

# Oven Maintenance

## Oven Care and Cleaning

### **⚠ WARNING**

Be sure electrical power is off and all surfaces are cool before cleaning any part of the appliance.

### **Cleaning Painted Parts and Decorative Trim**

- For general cleaning, use a cloth with hot, soapy water.
- For more difficult residue, apply liquid detergent directly on the area, and leave for 60 minutes. Wipe with a damp cloth, and dry. Do not use abrasive cleaners; they can scratch oven surfaces.

### **Cleaning Stainless Steel**

1. Shake a bottle of stainless steel appliance cleaner or polish well.
2. Place a dab of stainless steel appliance cleaner on a damp cloth or paper towel.
3. Clean a small area, rubbing with the grain of the steel if applicable.
4. Dry and buff with a clean, dry paper towel or soft cloth.

### **📄 NOTE**

Some paper towels tend to scratch stainless, test on a inconspicuous location before using.

5. Repeat as needed.

### **📄 NOTE**

- Do not use a steel-wool pad. It will scratch the surface.
- If the range was last cleaned with a mineral-oil-based stainless-steel cleaner, wash the surface with dish soap and water before using the stainless-steel cleaner.

### **About the Convection Filter**

The convection filter is in the back of each oven chamber. Clean the filter regularly. If it becomes clogged, the oven's convection cooking modes will not work properly. Always remove the filter before self-cleaning.

### **📄 NOTE**

For best performance, re-install the convection filter before cooking. Not doing so will damage the blade and cookware, and potentially injure the user.

### **📄 NOTE**

### **Removing/Re-installing the Convection Filter**

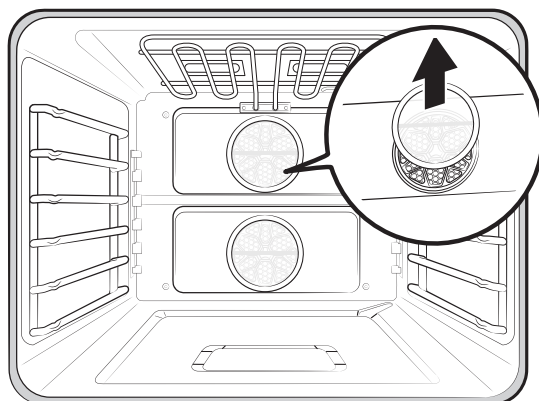

When the oven is cool, grasp the edges of the filter, and gently push up.

### **Cleaning the filter**

Put the filter on the top rack of a dishwasher, or soak the filter in hot, soapy water, then rinse it well. Dry the filter before re-installing it.

# Oven Maintenance

## Oven Care and Cleaning, cont.

### Removing/Re-installing the Convection Filter, cont.

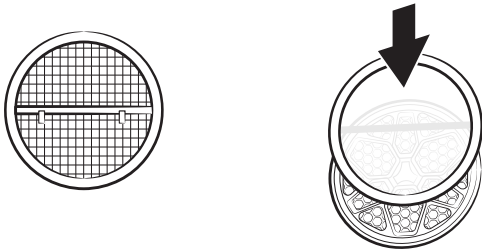

Centering the filter over the fan hole, carefully hook the metal clips (back of filter) over the metal bar across the hole. Do not scratch the oven's porcelain with the filter.

### Oven Racks

- If left in the oven during self-cleaning, the racks will discolor and will not slide as easily on their tracks. When the oven is cool, rub the rack sides with wax paper or a bit of oil to help the racks glide more easily on their tracks.
- Clean gliding racks by hand with an abrasive cleaner or steel wool. Do not let water or cleaner enter the rack slides.

### NOTE

- Do not clean the racks in a dishwasher.
- If the rack does not slide easily, it can be treated with an FDA-approved graphite lubricant. (Graphite lubricant can be purchased from many stores and online.)

### Lubricating the Gliding-Rack Slides

Do not lubricate the gliding rack with cooking spray or other such sprays.

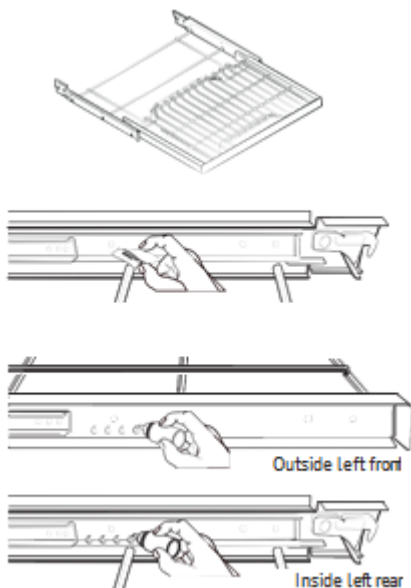

1. Remove the rack from the oven. (See **Using the Gliding Rack**, Pg. 27.)
2. Fully extend the rack on a surface covered with newspaper or cloth.
3. With paper towel, wipe debris from the slide tracks.
4. Shake the graphite lubricant before opening it. Starting with the rack's left (front, back) slide mechanism, place 4 small drops of lubricant on the 2 bottom tracks of the slide close to the bearing carriers (see left).
5. Repeat for the right (front, back) slide mechanism.



# Oven Maintenance

---

## Oven Care and Cleaning, cont.

---

### Removing/Re-installing the Rack Supports

Rack supports can be removed for cleaning. (Self-Cleaning, GreenClean™ and Manual cleaning).



1. Grasp the bottom-center of the support, and lift.

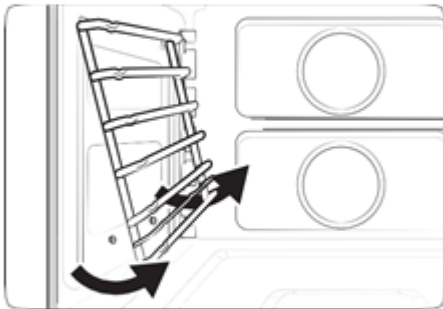

2. Swing the support bottom outward about 45°.

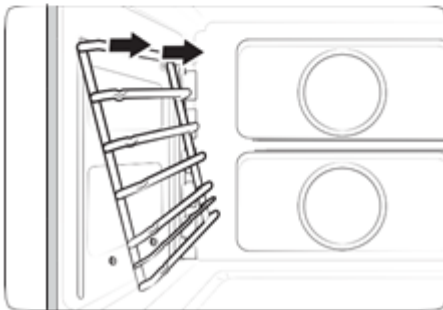

3. Pull the rack support from the mounting holes.

# Oven Maintenance

---

## Oven Care and Cleaning, cont.

---

### Removing/Re-installing the Rack Supports, cont.

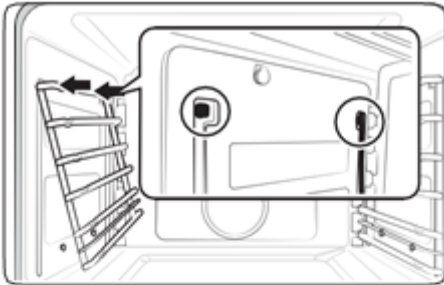

4. Insert the rack-support prongs into the holes near the top of the oven-chamber wall.

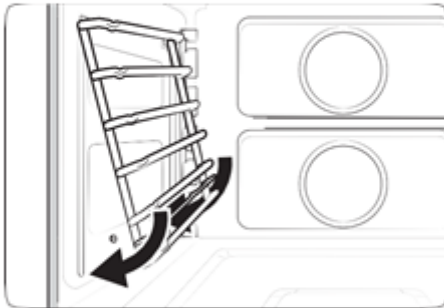

5. Swing the bottom of the rack support toward the oven-chamber wall.

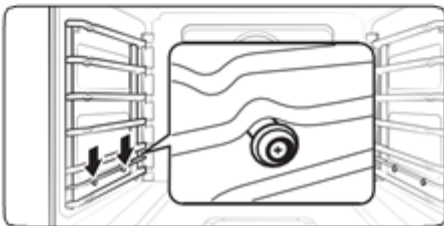

6. Pull the rack support down, making sure the two humps on the support bar rest upon the nuts attached to the oven-chamber wall.

### Cleaning the Oven Door

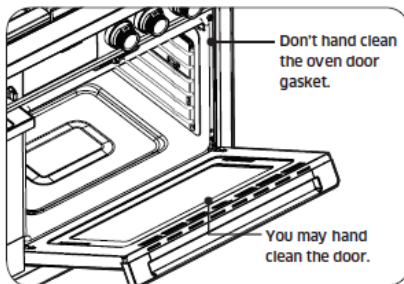

- Clean the oven door surfaces with soap and water, and rinse well. Clean the exterior door glass with glass cleaner. Do not immerse the door in water. Keep liquids out of the door vents. Do not use oven cleaners, cleansers, or abrasive cleaners on the outside of the door.
- DO NOT clean/rub/remove/damage the door gasket, which is made of a fragile material that is essential for a good seal.

# Oven Maintenance

## Removing/Re-installing the Oven Door

Spread a blanket on a stable, flat surface where you can lay the door once you have removed it.

### CAUTION

The 30" oven door weighs 42 lbs (19 kg). Grasp the door with both hands. Do not lift by the handle.

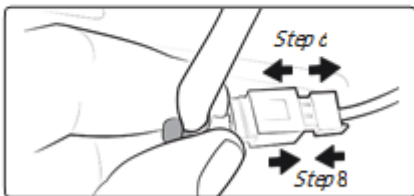

1. Open the oven door fully.
2. In the bottom corners of the oven door, flip the hinge locks toward you to unlock them. If the hinge locks are not fully forward (see left), you cannot remove the door.
3. Partially close the door to engage the hinge locks. (The door stops at this point.)
4. Grasp the sides of the door below the handle, and as you pull, gently jiggle the door side to side as needed to loosen it.
5. Set the door down without damaging the LED cable at the door's bottom right corner.
6. Disconnect the cable's wire harness, and set the door (handle-down), on the blanket you prepared.
7. When ready to re-install the door, stand at the top of the door, grasp each side below the handles, and take the door to the oven.
8. Set the door down, and connect the wire harness.
9. Holding the door at a 45° angle, insert the hinges in the slots. (A slight drop engages the hinges.)
10. Fully open the door. (If it does not open 90°, repeat Steps 7 – 9.)
11. Flip the hinge locks forward to lock them, and close the door. (The gap between door and control panel should be even; if not, the hinge on the wide end of the gap is not seated properly.)
12. Stuff the wire harness into its hole, and re-insert the rubber seal.

# Oven Maintenance

---

## Changing the Oven Light

---

The oven light is a standard 40-watt halogen appliance bulb. It comes on when the oven door is opened. When the door is closed, touch LIGHT to turn the light on/off. The light does not work during self-cleaning. Wear gloves to halogen bulbs.

### CAUTION

Before starting, ensure all oven surfaces are cool, then turn off power to the oven at the circuit-breaker panel or fuse box.

1. Support the broil element, and turn the round nut counterclockwise. The element loosens and tilts down. (The broil element is not removable; do not force it down or let it drop.)
2. Remove the glass cover, then the bulb cover.
3. Replace the halogen bulb, then the glass cover.
4. Lift the broil element into position, and turn the nut clockwise to hold the element in place.

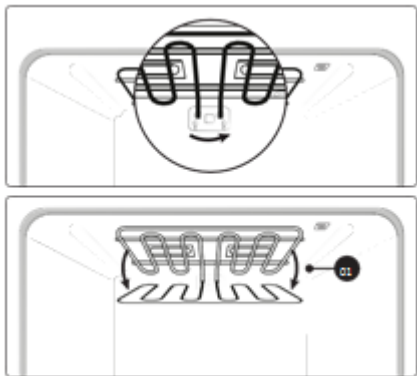

# Oven Maintenance

If you experience an issue with your range, review the tables in this section to resolve it. If you cannot find a solution, call Dacor Customer Assurance (800-793-0093) for assistance.

## Gas Safety

Problem	Possible cause	Action
You smell gas	Burner is ON, but burner is not lit.	Turn the burner knob to OFF.
	Gas leak.	<ul style="list-style-type: none"> <li>Evacuate the building.</li> <li>From a neighbor's home (your phone may cause a spark that ignites the gas), immediately call the gas supplier, and follow their directions. (If you cannot reach your gas supplier, call the fire department.)</li> </ul>

## Surface Burner

Problem	Possible causes	Action
No burners light	Cooktop is unplugged.	Ensure power cord is plugged into a live, grounded outlet.
	Blown fuse/tripped circuit breaker.	Replace fuse/reset circuit breaker.
	Gas supply not on or improperly connected.	See the Installation Instructions.
Burner does not light	Control knob not set properly.	Push in knob and turn to Lite position.
	Burner caps not in place or burner base misaligned.	<ul style="list-style-type: none"> <li>Clean the electrodes.</li> <li>Put burner cap on burner head.</li> <li>Align burner base.</li> </ul>
Burner clicks during operation	Control knob left in Lite position.	After burner ignites, turn knob to desired setting; if burner still clicks, contact service technician.
Burner not burning evenly	Burner improperly assembled.	See Pg. 62.
	Dirty burners.	Clean the burner components, see Pg. 60.
Very large or yellow burner flames	Wrong burner orifice installed.	Check orifice size; contact installer if you have wrong orifice (LP gas, natural gas or vice versa).

## Control Display

Problem	Possible cause	Solution
Display goes blank	Bad fuse/tripped circuit breaker.	Replace fuse/reset circuit breaker.
Control panel not responding	Moisture/residue on panel; Control Lock enabled.	Remove moisture/residue, retry; disable Control Lock.

# Troubleshooting

## Oven

Problem	Possible cause	Solution
Oven not turning on	Oven not fully plugged in.	Verify the range plug is properly inserted in its outlet.
	Bad fuse/tripped circuit breaker.	Replace fuse/reset circuit breaker.
	Oven controls improperly set.	See <b>Using the Steam Oven</b> , Pgs. 55, 56.
	Oven too hot.	Let oven cool.
	Incomplete service wiring.	Call for service.
	Power outage.	Check house lights. call utilities provider if needed.
Oven light not turning on	Light loose/defective.	Tighten/replace lamp; call for service if door light stays off.
	Broken light switch.	Call for service.
Excessive smoke during broiling	Oven controls improperly set.	See <b>Using the Steam Oven</b> , Pgs. 55, 56.
	Meat too close to broil element.	Lower the rack one level
	Meat not properly prepared.	Trim excess fat from around meat.
	Grease buildup in oven.	Clean oven more frequently.
Food not baking/ roasting properly	Oven controls incorrectly set.	See <b>Using the Steam Oven</b> , Pg. 55, 56.
	Mispositioned/unlevel rack.	See <b>Using the Oven Racks</b> , Pg. 26.
	Oven temp improperly set.	See <b>Temp in Settings</b> , Pg. 50.
Food not broiling properly	Serving size may be unsuitable.	See <b>Broiling Recommendation Guide</b> , Pg. 32 and retry.
	Rack not well positioned.	See <b>Broiling Recommendation Guide</b> , Pg. 32
	Cookware not good for broiling.	Use cookware suitable for broiling.
	Voltage may be insufficient.	Preheat broiler 10 min's; see <b>Broiling Recommendation Guide</b> , Pg. 32.
Cook temp too hot/ cold	Adjust oven temperature.	See <b>Temp in Settings</b> , Pg. 50.
Water is dripping	Type of food being cooked.	Not a malfunction; let oven cool, then wipe with dry dish towel.
Steam comes out seam between oven chassis and door		
Water stays in oven		
Boiling sounds when steam cooking	Water being heated by steam heater.	Not a malfunction.
Oven will not self- clean	Oven too hot for self-cleaning.	Let oven cool, then reset controls. (See Pg. 39.)
	Oven controls incorrectly set.	See <b>Self-Cleaning</b> , Pg. 39.
	Control Lockout enabled.	Disable control lockout (see Pg. 49).
Excessive smoke while self-cleaning.	Excessive residue in the oven.	Press OFF; open windows to vent smoke; wait for self-cleaning to cancel, and wipe up excessive soil, then restart self-cleaning.
Oven door not opening after self- cleaning.	Oven too hot.	Let oven cool.

# Troubleshooting

## Oven, cont.

Problem	Possible cause	Solution
Oven still dirty after self-cleaning.	Oven controls incorrectly set.	See <b>Self-Cleaning</b> , Pg. 39.
	Oven too heavily soiled.	Wipe up food residue, then start self-cleaning; very dirty ovens may need two self-cleaning cycles or longer cycles.
Steam emitting from vent.	When using convection, steam normally emits from oven vent.	This is normal operation.
	Large quantity of food cooking.	
Burning or oily odor emitting from vent.	New oven.	To eliminate the smell faster, set self-cleaning 3+ hrs. (See <b>Self-Cleaning</b> , Pg. 39.)
Strong odor.	Insulation in new oven.	Run oven empty on Bake at 400 °F for 1 hr.
Fan noise.	Convection fan cycling on/off.	This is normal operation.
Oven racks hard to slide.	Chrome racks were left in oven during self-cleaning.	Apply a dab of veg. oil to paper towel, and wipe oven-rack edges.
Oven door is locked.	Tripped circuit breaker or power outage while door was locked	Enable Control Lockout, then unlock the control. See <b>Using Control Lockout</b> , Pg. 49.

## Information Codes

Displayed code	Possible cause	Solution
C-d1	Occurs if door lock is mispositioned.	Press OFF, and restart oven. If issue persists, disconnect power to oven for at least 30 sec's, then reconnect. If issue is not resolved, call for service.
C-F0	Communication between Main and Sub PBA was interrupted.	
C-F2	Communication between Main and Touch was interrupted.	
C-20	Oven sensor is either open or short when oven is on.	
C-21	Occurs if internal temp is unusually high.	Restart appliance.
C-23	Temp probe sensor is short when oven is on.	Press OFF, and restart oven. If issue persists, disconnect power to oven for at least 30 sec's, then reconnect. If issue is not resolved, call for service.
C-30	PCB sensor is either open or short when oven is on.	
C-31	Occurs if PCB temp is unusually high.	Call for service
C-70	Steam sensor is either open or short when oven is on.	Press OFF, and restart oven. If issue persists, disconnect power to oven for at least 30 sec's, then reconnect. If issue is not resolved, call for service.
C-72	Problem with drain system.	
C-A2	Problem with cooling motor.	Call for service.

# Warranty and Service

---

## Warranty

---

### What Is Covered

CERTIFICATE OF WARRANTIES: DACOR RANGES WITHIN THE 50 STATES OF THE USA, THE DISTRICT OF COLUMBIA, AND CANADA:

#### FULL 2-YEAR WARRANTY

The warranty applies only to Dacor Modernist appliances sold to the original purchaser, starting from the original retail purchase date or closing date for new construction, whichever period is longer. The warranty is valid on Modernist products purchased new from a Dacor Authorized Dealer or other Dacor-authorized seller.

If, within 2 years of the original purchase date, your Dacor Modernist product malfunctions due to material or manufacturing defect, Dacor will restore the appliance to its proper function at no charge to you.

All cosmetic damage (e.g., scratches on stainless steel, paint/porcelain blemishes) to the appliance or included accessories must be reported to Dacor within 60 days of the original purchase date to qualify for warranty coverage.

#### LIMITATIONS OF COVERAGE

Service will be provided by a Dacor-designated service company during regular business hours. These providers are independent entities and not Dacor agents. Dealer display and model-home- display products with a production date greater than 5 years, products sold "As Is," and products installed for non-residential use (religious organizations, fire stations, bed & breakfast, spas, etc.) carry a 1-year parts warranty only. All delivery, installation, labor costs, and other service fees are the purchaser's responsibility.

The warranty is null and void:

- on any product whose serial numbers and tags have been altered/defaced/removed.
- if a non-ETL-/non-CUL-approved product is transported from the USA.

The owner must provide proof of purchase or closing statement for new construction upon request. All Dacor products must be accessible for service.

OUTSIDE THE 50 STATES OF THE USA, THE DISTRICT OF COLUMBIA, AND CANADA:

#### LIMITED FIRST-YEAR WARRANTY

If your Dacor product malfunctions within 1 year of the original purchase date due to a defect in material or workmanship, Dacor will furnish a new part, FOB factory to replace the defective part. Delivery, installation, labor costs, and other service fees are the purchaser's responsibility.



# Warranty and Service

---

## Warranty, cont.

---

### What Is Not Covered

- Slight color variations due to differences in painted parts, kitchen lighting, product location, and other factors.
- Service calls to educate the owner on product use and care.
- Service fees for travel to islands and remote areas (including but not limited to ferries, toll roads, and other travel expenses).
- Consequential or incidental damage (including but not limited to food or medicine loss, lost work time, or restaurant meals).
- Product failure under non-residential circumstances (e.g., commercial, industrial, b&b, religious organization).
- Product failure due to improper installation.
- Consumable parts (e.g., filters, light bulbs).
- Replacement of house fuses, fuse boxes, or resetting of circuit breakers.
- Damage due to so-called "acts of God" (e.g., fire, flood, power outage/surge).
- Liability for damage to surrounding property (e.g., cabinetry, floors, ceilings, countertops).
- Breakage/discoloration/damage to glass, metal surfaces, plastic parts, trim, paint, or other cosmetic finish due to abuse, neglect, improper use/care.

### Out-of-Warranty Products

Should you experience a service issue after the standard warranty period expires, contact us nonetheless. Dacor reviews each issue and customer concern to provide the best possible solution for the customer under the individual circumstances.

THE REMEDIES IN THE ABOVE EXPRESS WARRANTIES ARE THE SOLE AND EXCLUSIVE REMEDIES; THUS, NO OTHER EXPRESS WARRANTIES ARE MADE, AND OUTSIDE THE 50 STATES OF THE UNITED STATES, THE DISTRICT OF COLUMBIA AND CANADA, ALL IMPLIED WARRANTIES, INCLUDING BUT NOT LIMITED TO, ANY IMPLIED WARRANTY OF MERCHANTABILITY OR FITNESS FOR A PARTICULAR USE OR PURPOSE, ARE LIMITED IN DURATION TO 1 YEAR FROM THE ORIGINAL PURCHASE DATE. DACOR SHALL NOT BE LIABLE FOR INCIDENTAL EXPENSE OR CONSEQUENTIAL DAMAGES. SHOULD DACOR PREVAIL IN ANY LAWSUIT, DACOR SHALL BE ENTITLED TO REIMBURSEMENT OF ALL COSTS AND EXPENSES, INCLUDING ATTORNEY'S FEES, FROM THE DACOR CUSTOMER. NO WARRANTIES, EXPRESS OR IMPLIED, ARE MADE TO ANY BUYER FOR RESALE.

Some states do not allow limitations on how long an implied warranty lasts, or do not allow the exclusion or limitation of inconsequential damages; therefore, the above limitations or exclusions may not apply to you. This warranty gives you specific legal rights, and you may also have other rights that vary from state to state.

# Open-Source Announcement

---

The software included in this product contains open-source software. You may obtain the complete corresponding source code for 3 years after the last shipment of this product by emailing: <mailto:oss.request@samsung.com>.

You may also obtain the complete corresponding source code via physical medium (e.g., CD-ROM) at a minimal charge.

The URL [http://opensource.samsung.com/opensource/OVEN\\_HKM\\_TZ/seq/0](http://opensource.samsung.com/opensource/OVEN_HKM_TZ/seq/0) leads to the download page of the source code made available and open-source license information as related to this product. This offer is valid to anyone in receipt of this information.





Please visit [www.dacor.com](http://www.dacor.com) to activate your warranty online.

# WARRANTY INFORMATION

**IMPORTANT:**

Your warranty will not be activated until you activate it online or return this form to Dacor. If you have purchased more than one Dacor product, please return all forms in one envelope, or activate the warranty online for each product.

Please be assured that Dacor will never sell your name or any information on this form for mailing-list purposes, as we do not consider it a proper way of expressing our gratitude for your having chosen Dacor products for your kitchen!

Owner Last Name (please print) \_\_\_\_\_ First \_\_\_\_\_ Middle Init. \_\_\_\_\_

Street \_\_\_\_\_

City \_\_\_\_\_ State \_\_\_\_\_ Zip \_\_\_\_\_

Purchase Date \_\_\_\_\_ Email \_\_\_\_\_ Phone \_\_\_\_\_

Dealer \_\_\_\_\_

City \_\_\_\_\_ State \_\_\_\_\_ Zip \_\_\_\_\_

Your willingness to take a few seconds to complete the section below will be sincerely appreciated. Thank you.

1. How were you first exposed to Dacor products? (Please check one.)

- A. T.V. Cooking Show
- B. Magazine
- C. Appliance Dealer Showroom
- D. Kitchen Dealer Showroom
- E. Home Show
- F. Builder
- G. Architect/Designer
- H. Another Dacor Owner
- I. Model Home
- J. Other \_\_\_\_\_

2. Where did you buy your Dacor appliances?

- A. Appliance Dealer
- B. Kitchen Dealer
- C. Builder Supplier
- D. Builder
- E. Other \_\_\_\_\_

3. For what purpose was the product purchased?

- A. Replacement only
- B. Part of a Remodel
- C. New Home
- D. Other \_\_\_\_\_

4. What is your household income?

- A. Under \$75,000
- B. \$75,000 – \$100,000
- C. \$100,000 – \$150,000
- D. \$150,000 – \$200,000
- E. \$200,000 – \$250,000
- F. Over \$250,000

5. What other brands of appliances do you have in your kitchen?

- A. Cooktop \_\_\_\_\_
- B. Oven \_\_\_\_\_
- C. Dishwasher \_\_\_\_\_
- D. Refrigerator \_\_\_\_\_

6. Would you buy or recommend another Dacor product?

- Yes
- No

Comments \_\_\_\_\_

\_\_\_\_\_

\_\_\_\_\_

Thank you very much for your assistance. The information you have provided will be extremely valuable in helping us plan for the future and in giving you the support you deserve.



cut here

cut here

fold here



NO POSTAGE  
NECESSARY  
IF MAILED  
IN THE  
UNITED STATES

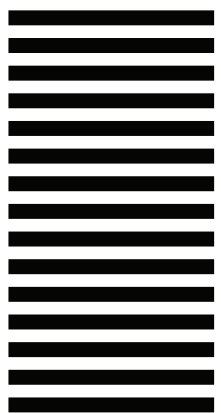

**BUSINESS REPLY MAIL**  
FIRST-CLASS MAIL PERMIT NO 1600 CITY OF INDUSTRY CA

POSTAGE WILL BE PAID BY ADDRESSEE

**DACOR**  
**ATTN WARRANTY PROCESSING DEPT**  
**PO BOX 90070**  
**CITY OF INDUSTRY CA 91715-9907**

