

Project: _____

Type: _____

Note: _____

2", 3", 5" LED CYLINDER - PENDANT



2" Pendant Cylinder Stem with Standard Retro Fit Canopy

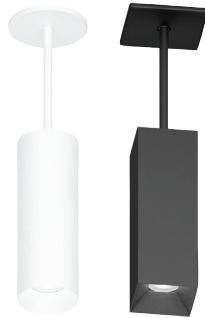

3" Pendant Cylinder Stem with Standard Retro Fit Canopy



5" Pendant Cylinder Stem with Standard Retro Fit Canopy



5" Pendant Cylinder Stem with Conduit 3-1/4" Canopy*

*Conduit 3-7/8" Canopy also available

LED LIGHT ENGINE	
RATED WATTAGE	2" (10W-20W), 3" (15W-30W), 5" (15W-50W)
DELIVERED LUMENS	Up to: 2" 1943 lm, 3" 3175 lm, 5" 4975 lm
CCT/CRI	2700K 90CRI, 3000K 90CRI, 4000K 80CRI, WARM DIM 98CRI
COLOR QUALITY	2700K-3500K 90+ CRI, 2-Step SDCM
LED LIFETIME	55,000 hours @ L90

SILENT VU™ OPTICS TECHNOLOGY	
OPTICS	10°, 30°, 50°, 80° Available
ADJUSTABLE	Non Adjustable
OPTICAL MEDIA	Clear, Solite, Frosted, Linear Spread, Hex Louver

SIZE	MAX POWER	LUMENS @ 3500K			
		10° Optic	30° Optic	50° Optic	80° Optic
2"	20 Watt	1530 lm	1633 lm	1506 lm	1271 lm
3"	30 Watt	2227 lm	2646 lm	2440 lm	2023 lm
5"	50 Watt	3877 lm	4252 lm	4228 lm	2858 lm

POWER SUPPLY	
INPUT VOLTAGE	120/277V, 50/60Hz
DIMMING	Multiple Dimming Drivers Available
SERVICABILITY	Light Module and Driver Field Serviceable

STANDARD FINISH

- WT (Semi Gloss White)
- MB (Matte Black)
- All custom finishes available (see p 5)

MOUNTING

- 5" x 1/8" canopy included with standard universal dim driver
- Additional Canopies included, New Construction, Alternative Driver, Conduit Canopies. See drawings for dimensions.
- 4' of stem included; (1) 6", (2) 12" & (1) 18" (includes couplers).
- 10' field adjustable cord available.
- Standard Driver canopy mounts a 4" round Junction Box
- Alternative Driver Canopy mounts to standard 4" round and square Junction Boxes.
- Conduit Canopies mount to 4" Octagon Junction Box.
- CC1: 1-1/2" tall Junction Box, CC2: 2-1/8" tall Junction Box
- Conduit Canopies are supplied with 4X 3/4" Open Conduit Covers and 3X Solid Covers.

LISTING/WARRANTY

- Five (5) year limited warranty
- UL Listed for 40°C Ambient
- cULus Listed for Wet Location
- CA Title 24-JA8 Compliant

CCT MULTIPLIER CHART

SIZE	2700K 90CRI	3000K 90CRI	3500K 90 CRI	4000K 90CRI	WARM DIM 98CRI
2"	0.92	0.97	1.00	1.19	0.62
3"	0.91	0.97	1.00	1.20	0.62
5"	0.92	0.96	1.00	1.17	0.57

POWER MULTIPLIER CHART

SIZE	10W	15W	20W	25W	30W	35W	40W	50W
2"	0.60	0.80	1.00					
3"		0.57	0.65	0.78	1.00			
5"		0.37	0.48	0.58	0.68	0.77	0.85	1.00



Project: _____
 Type: _____
 Note: _____

2", 3", 5" LED CYLINDER - PENDANT

2" PENDANT MOUNT ORDER MATRIX

2" Cylinder LED Pendant

(Example: LP2-10-27-30-CL-CL-WT-C-5-S-ST)

SHAPE	WATTAGE	CCT & CRI	OPTIC	MEDIA 1	MEDIA 2
LP2 Pendant Downlight 2" Round	-10 10W	-27 2700K 90CRI	-10 10° Spot	(blank) None	(blank) None
SLP2 Pendant Downlight 2" Square	-15 15W	-30 3000K 90CRI	-30 30° Narrow Flood	CL Clear Lens	CL Clear Lens
	-20 20W	-35 3500K 90CRI	-50 50° Flood	MP Solite Lens	MP Solite Lens
		-40 4000K 80CRI	-80* 80° Wide Flood	FR Frosted Lens	FR Frosted Lens
		-WD* Warm Dim 98CRI	*WD with 80° Optic not CA title 24 compliant.	LS Linear Spread Lens	LS Linear Spread Lens
		*Media 1 lens required. For WD with 10°, 30°, 50° Optic use MP (Solite Lens). For WD with 80° Optic use FR (Frosted Lens)		HEX Hex Louver	Holds 1 Media only when HEX selected

STANDARD FINISH	COASTAL COATING	REVISION	STANDARD DRIVER
-WT Semi Gloss White	(blank) None	-5 Revision	-S Universal Dim Driver: 1%-100% 0-10V, TRIAC, ELV, 120V/277V
-MB Matte Black	-C Coastal Coating		ALTERNATIVE DRIVER
- Color Finish			-L3 Lutron Dim Driver: 1%-100% EcoSystem, 120V/277V
See p 5 for Color Finish Codes			-EL1 EldoLED DALI Dim: 1%-100% DALI, 120V/277V
			-EL2 EldoLED Dim: 0.1%-100% 0-10V, 120V/277V
			-DMX DMX Dim: 1%-100% DMX, 120V/277V
			NOTE: Ambient temperature rated for 25°C

Accessories (2" Cylinder)

HANGING OPTIONS	CANOPY	OPTIC	MEDIA
-ST Stem - Retro Fit	(blank) Non Conduit	C2-10-OPTIC 10° Spot	C2-CL Clear Lens
-NCST Stem - New Construction	-CC1 Conduit 3-1/4" Canopy	C2-30-OPTIC 30° Narrow Flood	C2-MP Solite Lens
-BC 10' Black Cord - Retro Fit	-CC2 Conduit 3-7/8" Canopy	C2-50-OPTIC 50° Flood	C2-FR Frosted Lens
-WC 10' White Cord - Retro Fit		C2-80-OPTIC 80° Wide Flood	C2-LS Linear Spread Lens
-NCBC 10' Black Cord - New Construction	NOTE: CC1/CC2 Canopies only available with Standard Driver and ST, BC, or WC Hanging Options.		C2-HEX Hex Louver
-NCWC 10' White Cord - New Construction			

EMERGENCY OPTIONS		
EM-1000 25W Remote Inverter	EM-1003-CA 35W Remote Inverter - Title 20	EM-1006 25W Remote Inverter - Title 20
EM-1002* 10W Remote Emergency Driver - Title 20	EM-1004 50W Remote Inverter	

*EM-1002 not compatible with Standard Driver

Project: _____

Type: _____

Note: _____

2", 3", 5" LED CYLINDER - PENDANT

3" PENDANT ORDER MATRIX

3" Cylinder LED Pendant

(Example: LP3-25-35-50-CL-MB-C-6-S-ST)

SHAPE	WATTAGE	CCT & CRI	OPTIC	MEDIA 1	MEDIA 2
LP3 Pendant Downlight 3" Round	-15 15W	-27 2700K 90CRI	-10 10° Spot	(blank) None	(blank) None
SLP3 Pendant Downlight 3" Square	-20 20W	-30 3000K 90CRI	-30 30° Narrow Flood	CL Clear Lens	CL Clear Lens
	-25 25W	-35 3500K 90CRI	-50 50° Flood	MP Solite Lens	MP Solite Lens
	-30 30W	-40 4000K 80CRI	-80* 80° Wide Flood	FR Frosted Lens	FR Frosted Lens
		-WD* Warm Dim 98CRI	<small>*WD with 80° Optic not CA title 24 compliant.</small>	LS Linear Spread Lens	LS Linear Spread Lens
	<small>*Media 1 lens required. For WD with 10°, 30°, 50° Optic use MP (Solite Lens). For WD with 80° Optic use FR (Frosted Lens)</small>			HEX Hex Louver	Holds 1 Media only when HEX selected

STANDARD FINISH	COASTAL COATING	REVISION	STANDARD DRIVER
-WT Semi Gloss White	(blank) None	-6 Revision	-S Universal Dim Driver: 1%-100% 0-10V, TRIAC, ELV, 120V/277V
-MB Matte Black	-C Coastal Coating		ALTERNATIVE DRIVER
- Color Finish See p 5 for Color Finish Codes			-L3 Lutron Dim Driver: 1%-100% EcoSystem, 120V/277V
			-EL1 EldoLED DALI Dim: 1%-100% DALI, 120V/277V
			-EL2 EldoLED Dim: 0.1%-100% 0-10V, 120V/277V
			-DMX DMX Dim: 1%-100% DMX, 120V/277V
<small>NOTE: Ambient temperature rated for 25°C</small>			

Accessories (3" Cylinder)

HANGING OPTIONS	CANOPY	OPTIC	MEDIA
-ST Stem - Retro Fit	(blank) Non Conduit	C3-10-OPTIC 10° Spot	C3-CL Clear Lens
-NCST Stem - New Construction	-CC1 Conduit 3-1/4" Canopy	C3-30-OPTIC 30° Narrow Flood	C3-MP Solite Lens
-BC 10' Black Cord - Retro Fit	-CC2 Conduit 3-7/8" Canopy	C3-50-OPTIC 50° Flood	C3-FR Frosted Lens
-WC 10' White Cord - Retro Fit	<small>NOTE: CC1/CC2 Canopies only available with Standard Driver and ST, BC, or WC Hanging Options.</small>	C3-80-OPTIC 80° Wide Flood	C3-LS Linear Spread Lens
-NCBC 10' Black Cord - New Construction		C3-HEX Hex Louver	
-NCWC 10' White Cord - New Construction			

EMERGENCY OPTIONS

EM-1000 25W Remote Inverter	EM-1003-CA 35W Remote Inverter - Title 20	EM-1006 25W Remote Inverter - Title 20
EM-1002* 10W Remote Emergency Driver - Title 20	EM-1004 50W Remote Inverter	

*EM-1002 not compatible with Standard Driver

Project: _____

Type: _____

Note: _____

2", 3", 5" LED CYLINDER - PENDANT

5" PENDANT ORDER MATRIX

5" Cylinder LED Pendant

(Example: LP5-50-WD-80-MP-FR-WT-C-3-S-ST)

SHAPE	WATTAGE	CCT & CRI	OPTIC	MEDIA 1	MEDIA 2
LP5 Pendant Downlight 5" Round	-15 15W	-27 2700K 90CRI	-10 10° Spot	(blank) None	(blank) None
SLP5 Pendant Downlight 5" Square	-20 20W	-30 3000K 90CRI	-30 10° Spot	CL Clear Lens	CL Clear Lens
	-25 25W	-35 3500K 90CRI	-50 10° Spot	MP Solite Lens	MP Solite Lens
	-30 30W	-40 4000K 80CRI	-80* 10° Spot	FR Frosted Lens	FR Frosted Lens
	-35 35W	-WD* Warm Dim 98CRI	*WD with 80° Optic not CA title 24 compliant.	LS Linear Spread Lens	LS Linear Spread Lens
	-40 40W	*Media 1 lens required. For WD with 10°, 30°, 50° Optic use MP (Solite Lens). For WD with 80° Optic use FR (Frosted Lens)		HEX Hex Louver	Holds 1 Media only when HEX selected
	-50 50W				

STANDARD FINISH	COASTAL COATING	REVISION	STANDARD DRIVER
-WT Semi Gloss White	(blank) None	-3 Revision	-S Universal Dim Driver: 1%-100% 0-10V, *TRIAC, ELV, 120V/277V
-MB Matte Black	-C Coastal Coating		ALTERNATIVE DRIVER
- Color Finish			-L3 Lutron Dim Driver: 1%-100% EcoSystem, 120V/277V
See p 5 for Color Finish Codes			-EL1 EldoLED DALI Dim: 1%-100% DALI, 120V/277V
			-EL2 EldoLED Dim: 0.1%-100% 0-10V, 120V/277V
			-DMX DMX Dim: 1%-100% DMX, 120V/277V
			NOTE: Ambient temperature rated for 25°C

Accessories (5" Cylinder)

HANGING OPTIONS	CANOPY	OPTIC	MEDIA
-ST Stem - Retro Fit	(blank) Non Conduit	C5-10-OPTIC 10° Spot	C5-CL Clear Lens
-NCST Stem - New Construction	-CC1 Conduit 3-1/4" Canopy	C5-30-OPTIC 30° Narrow Flood	C5-MP Solite Lens
-BC 10' Black Cord - Retro Fit	-CC2 Conduit 3-7/8" Canopy	C5-50-OPTIC 50° Flood	C5-FR Frosted Lens
-WC 10' White Cord - Retro Fit		C5-80-OPTIC 80° Wide Flood	C5-LS Linear Spread Lens
-NCBC 10' Black Cord - New Construction	NOTE: CC1/CC2 Canopies only available with Standard Driver and ST, BC, or WC Hanging Options.		C5-HEX Hex Louver
-NCWC 10' White Cord - New Construction			

EMERGENCY OPTIONS

EM-1000 25W Remote Inverter	EM-1003-CA 35W Remote Inverter - Title 20	EM-1006 25W Remote Inverter - Title 20
EM-1002* 10W Remote Emergency Driver - Title 20	EM-1004 50W Remote Inverter	

*EM-1002 not compatible with Standard Driver

Project: _____

Type: _____

Note: _____

2", 3", 5" LED CYLINDER - PENDANT

STANDARD FINISH

(Stem Mount Shown)



WT

Semi Gloss White



MB

Matte Black

COLOR FINISH

(Stem Mount Shown)



FLG

Flannel Gray



PNA

Painted Natural
Aluminum



TBZ

Textured Bronze



TGP

Textured Graphite

2", 3", 5" LED CYLINDER - PENDANT

2" ROUND CYLINDER

LP2 (2" Round Cylinder Downlight - Pendant Stem Mount)

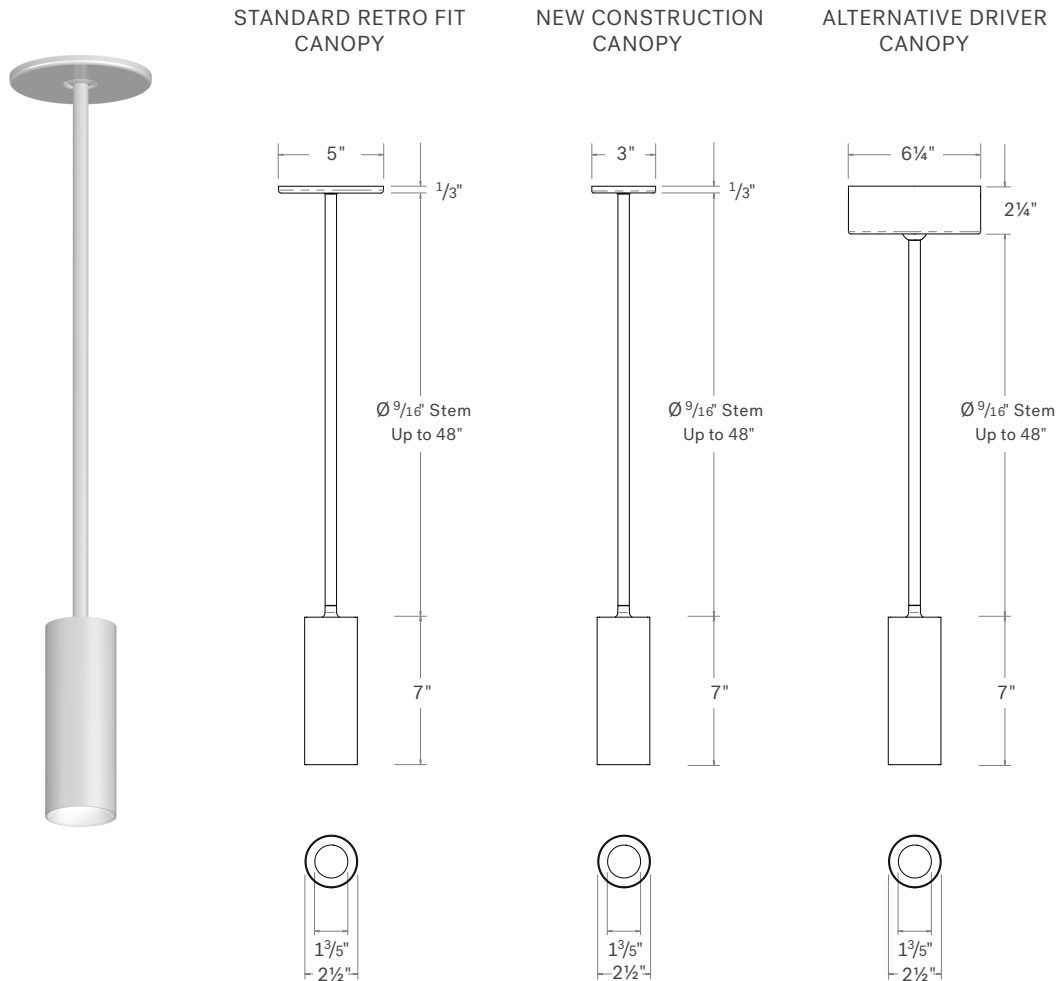

LP2 Stem Mount with CC1 and CC2 Conduit Canopy:

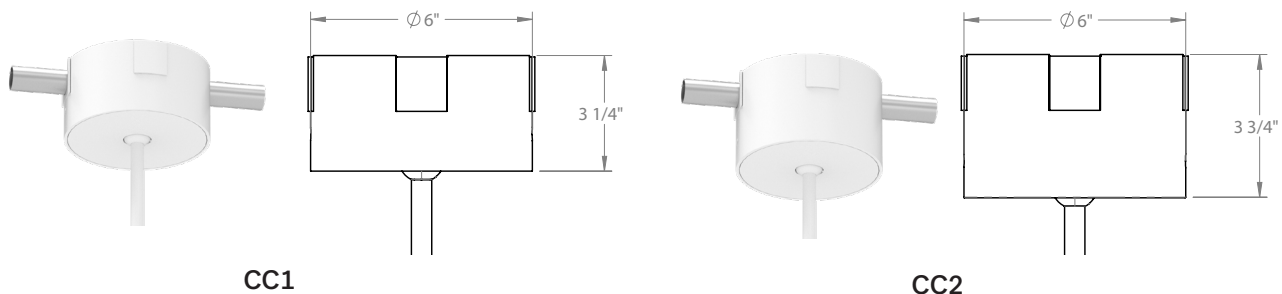

2", 3", 5" LED CYLINDER - PENDANT

2" ROUND CYLINDER

LP2 (2" Round Cylinder Downlight - Pendant Cord Mount)

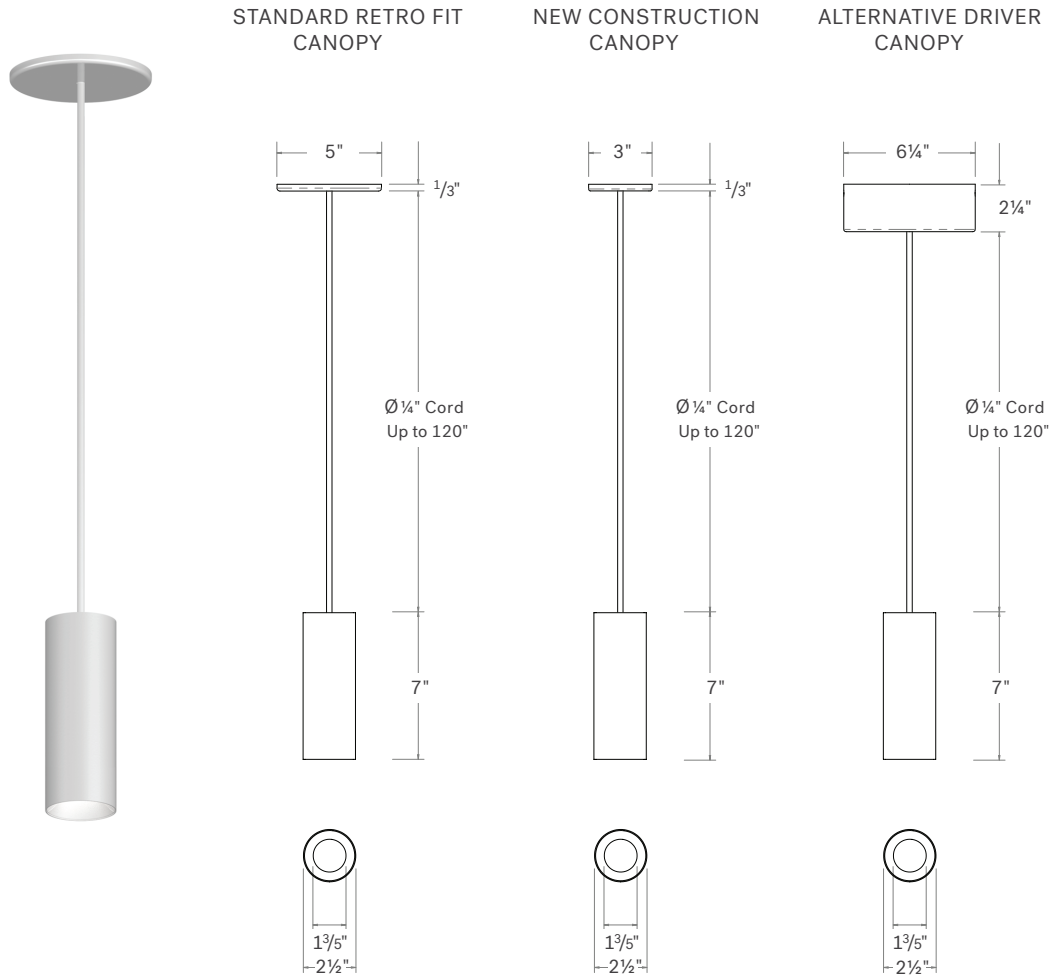

LP2 Cord Mount with CC1 and CC2 Conduit Canopy:

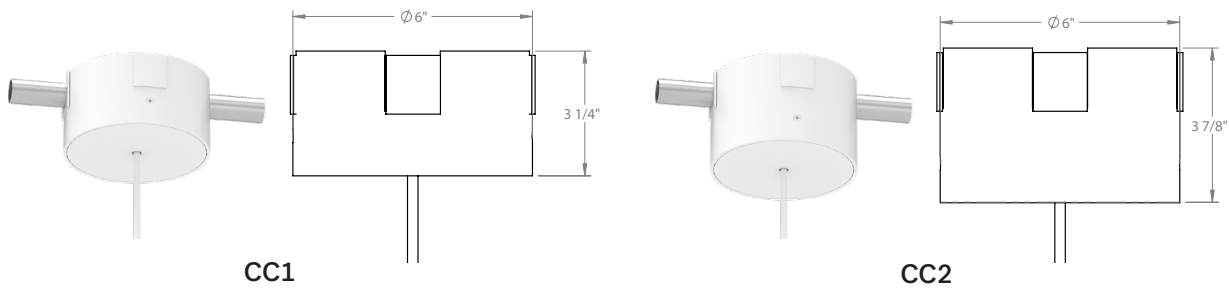

Project: _____
 Type: _____
 Note: _____

2", 3", 5" LED CYLINDER - PENDANT

2" SQUARE CYLINDER

SLP2 (2" Square Cylinder Downlight - Pendant Stem Mount)

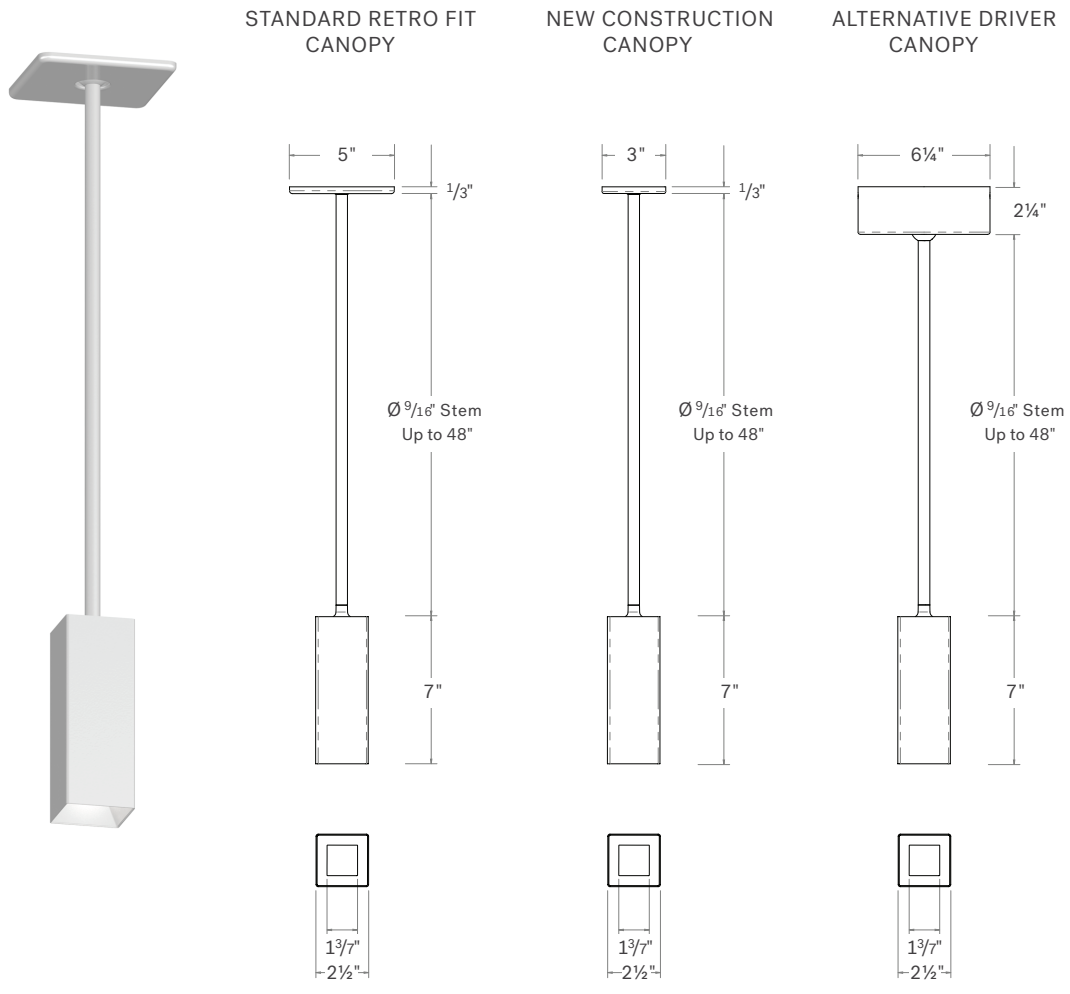

SLP2 Stem Mount with CC1 and CC2 Conduit Canopy:

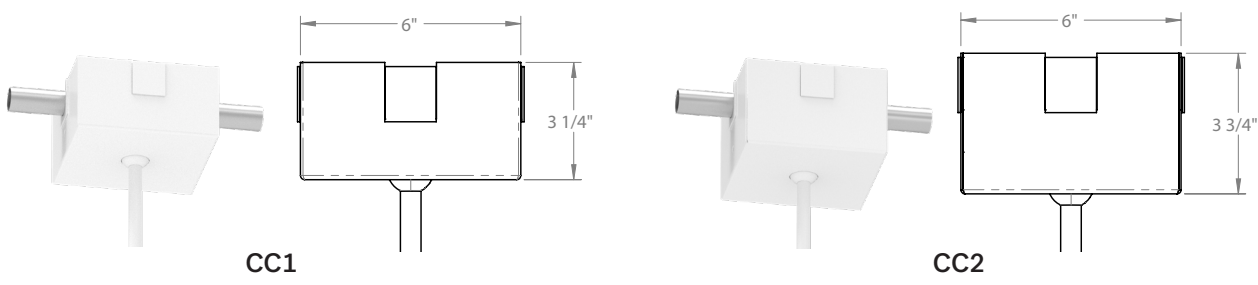

2", 3", 5" LED CYLINDER - PENDANT

2" SQUARE CYLINDER

SLP2 (2" Square Cylinder Downlight - Cord Stem Mount)

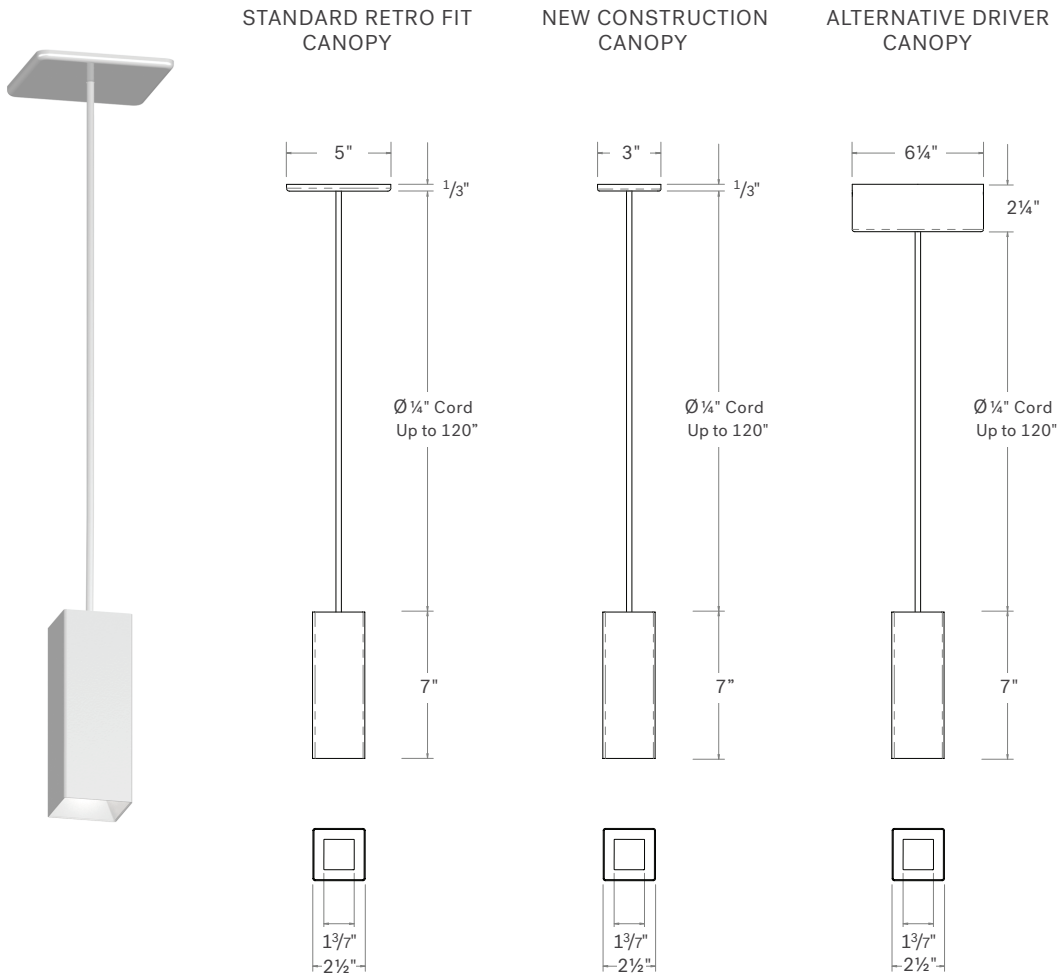

SLP2 Cord Mount with CC1 and CC2 Conduit Canopy:

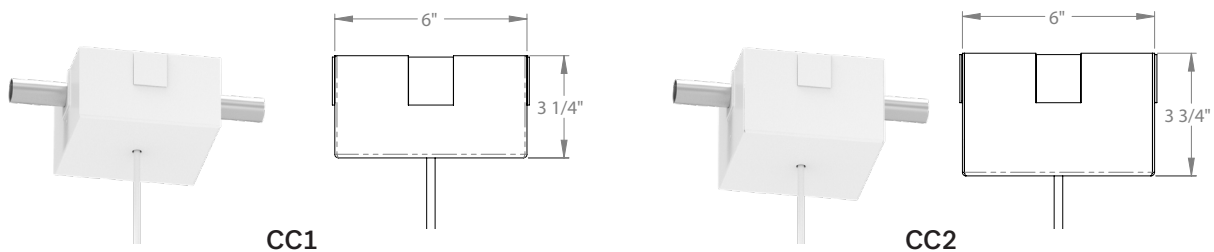

Project: _____
 Type: _____
 Note: _____

2", 3", 5" LED CYLINDER - PENDANT

3" ROUND CYLINDER

LP3 (3" Round Cylinder Downlight - Pendant Stem Mount)

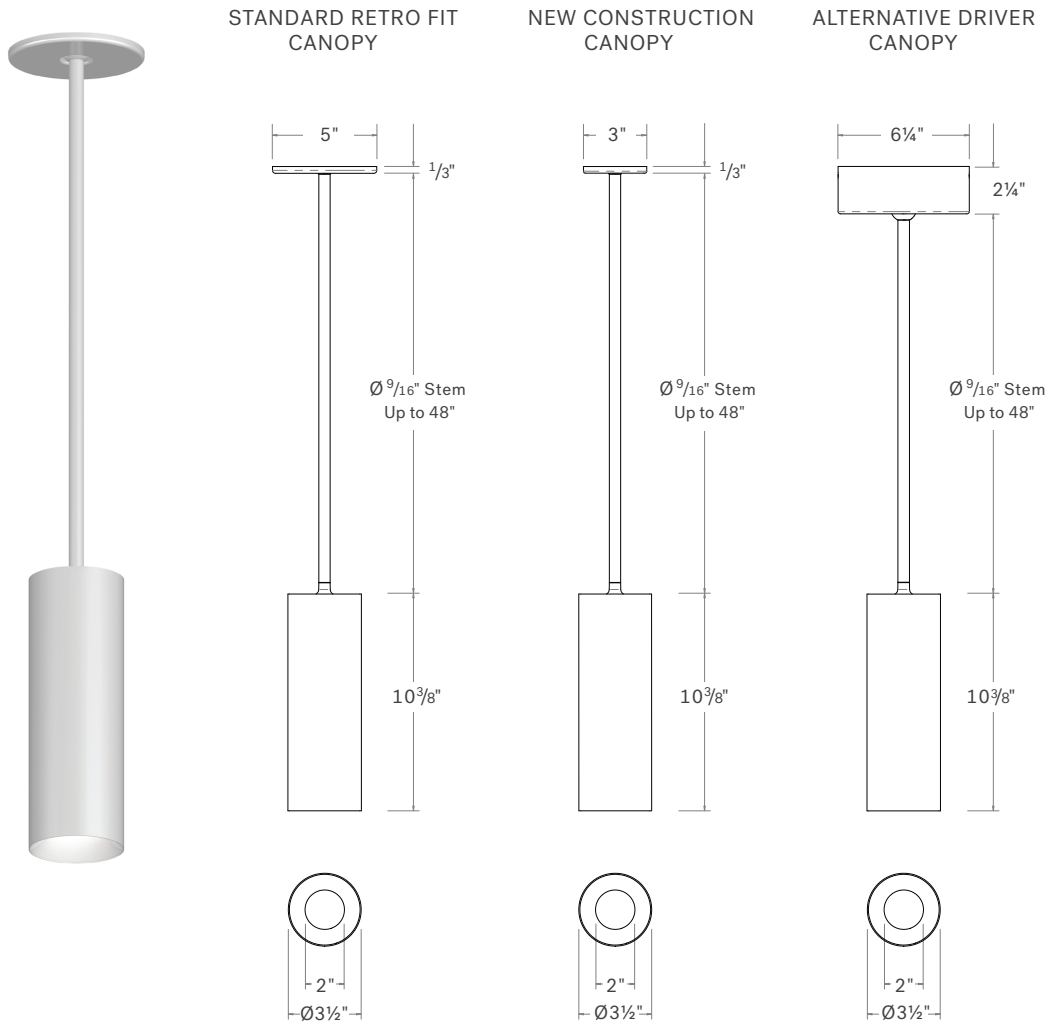

LP3 Stem Mount with CC1 and CC2 Conduit Canopy:

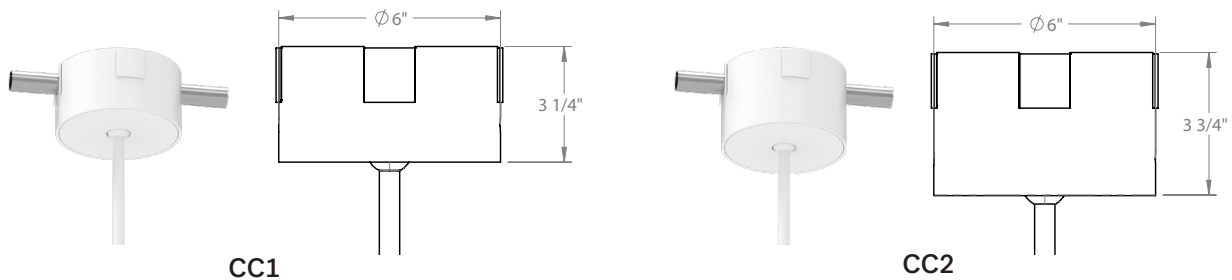

2", 3", 5" LED CYLINDER - PENDANT

3" ROUND CYLINDER

LP3 (3" Round Cylinder Downlight - Pendant Cord Mount)

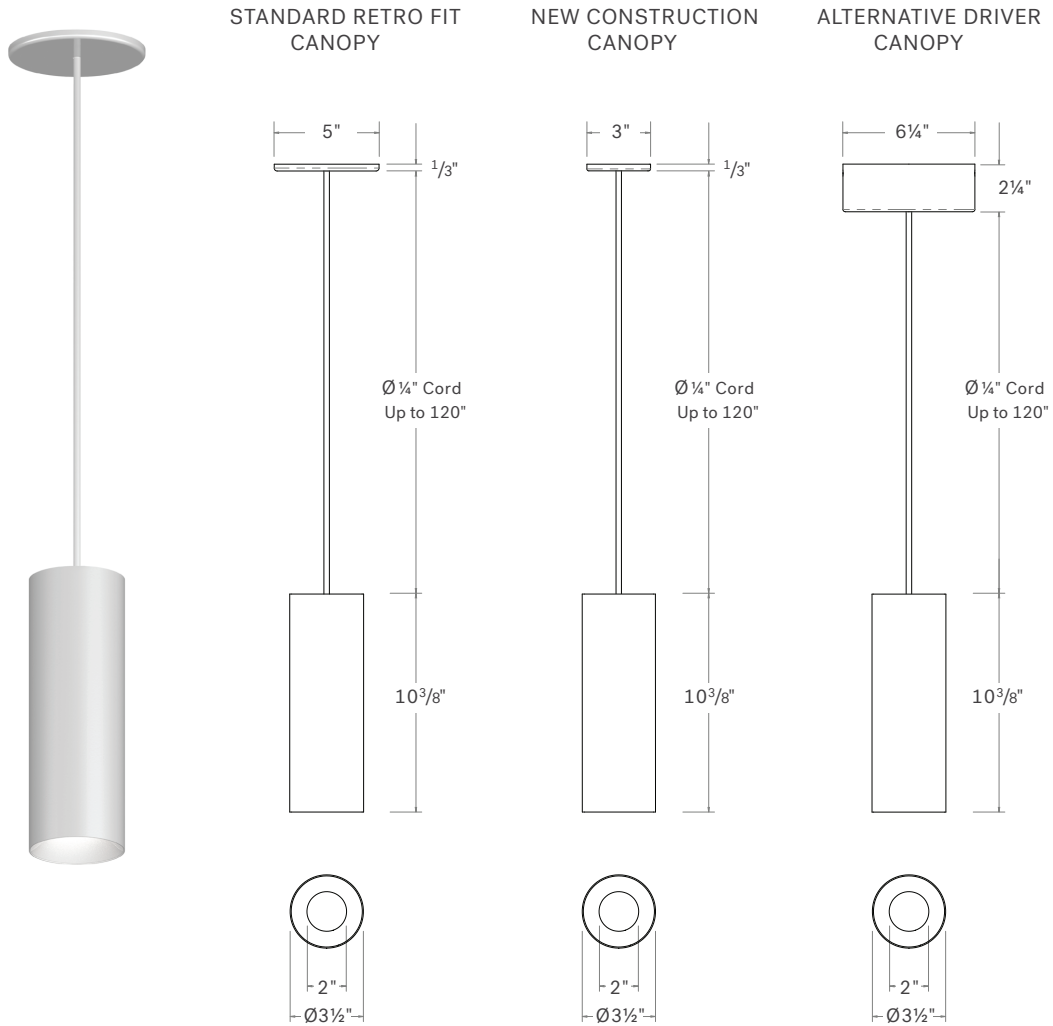

LP3 Cord Mount with CC1 and CC2 Conduit Canopy:

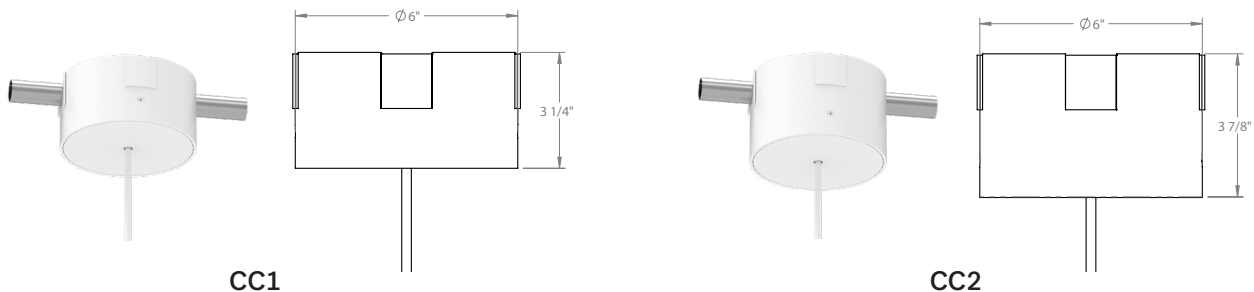

2", 3", 5" LED CYLINDER - PENDANT

3" SQUARE CYLINDER

SLP3 (3" Square Cylinder Downlight - Pendant Stem Mount)

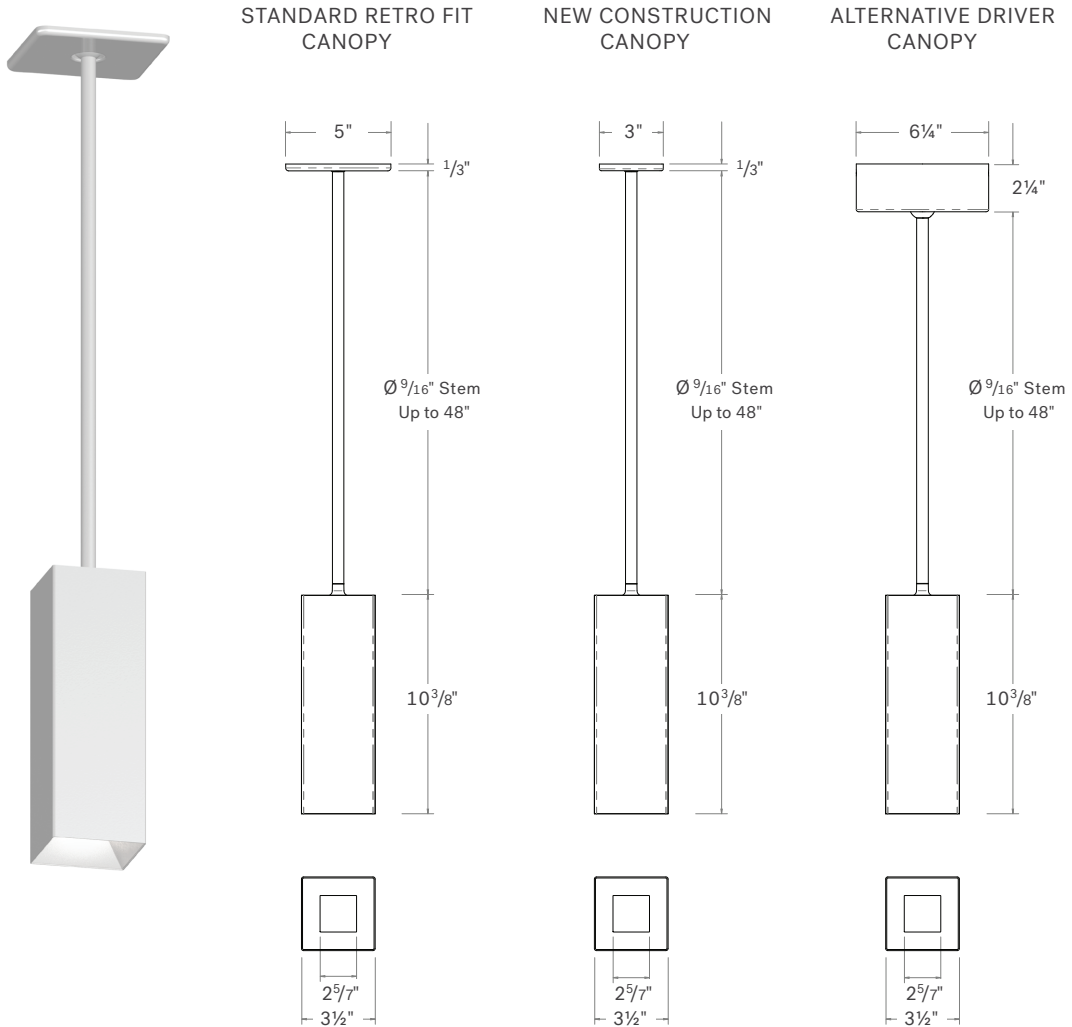

SLP3 Stem Mount with CC1 and CC2 Conduit Canopy:

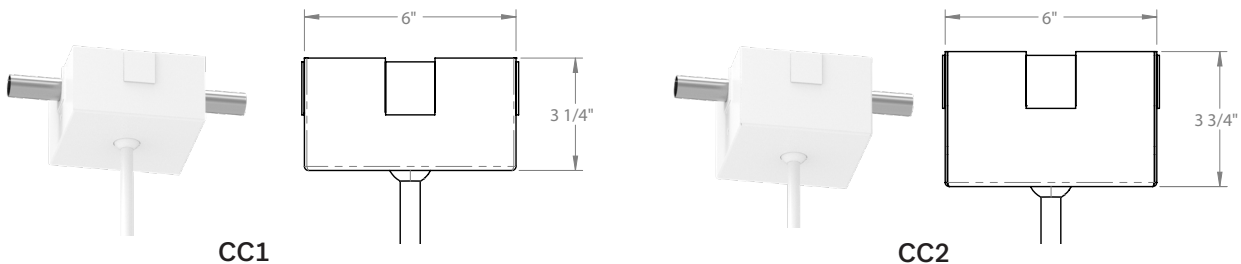

2", 3", 5" LED CYLINDER - PENDANT

3" SQUARE CYLINDER

SLP3 (3" Square Cylinder Downlight - Cord Stem Mount)

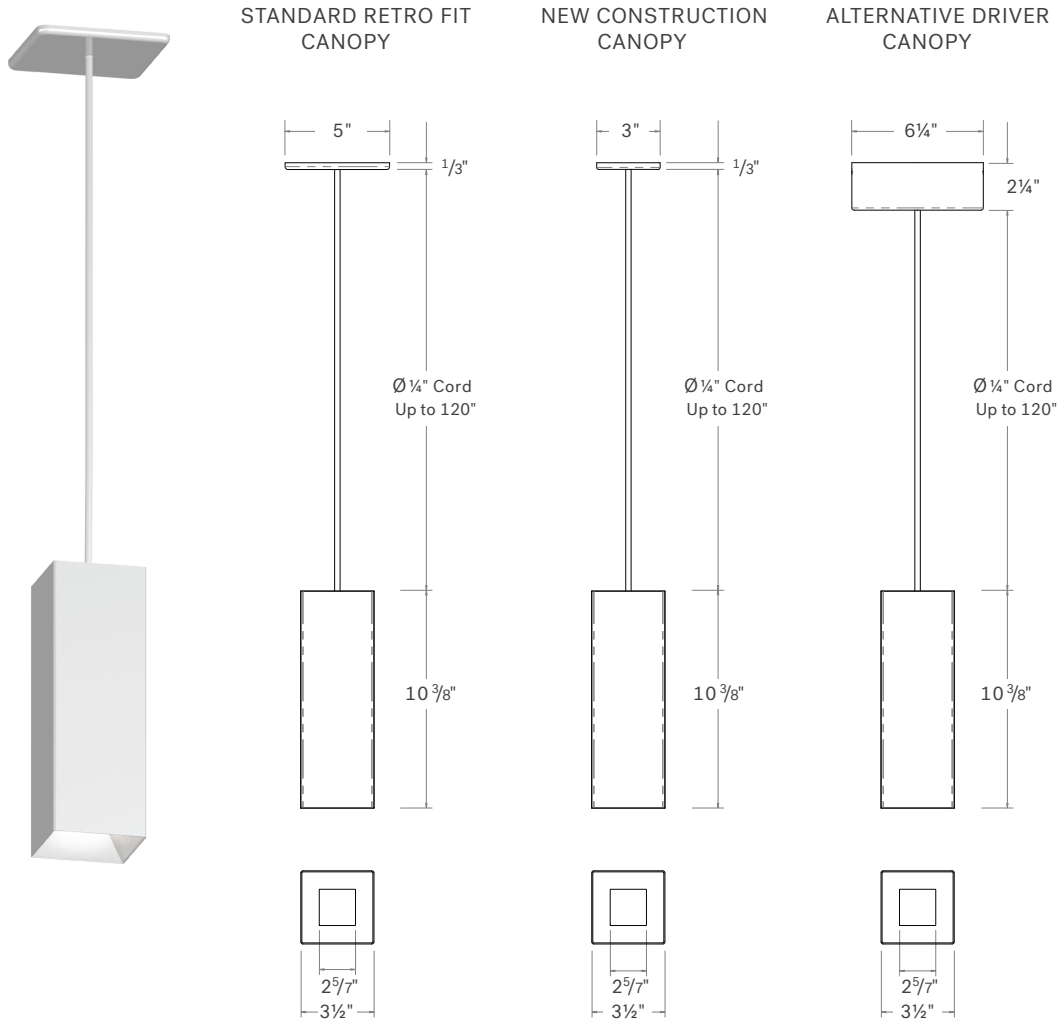

SLP3 Cord Mount with CC1 and CC2 Conduit Canopy:

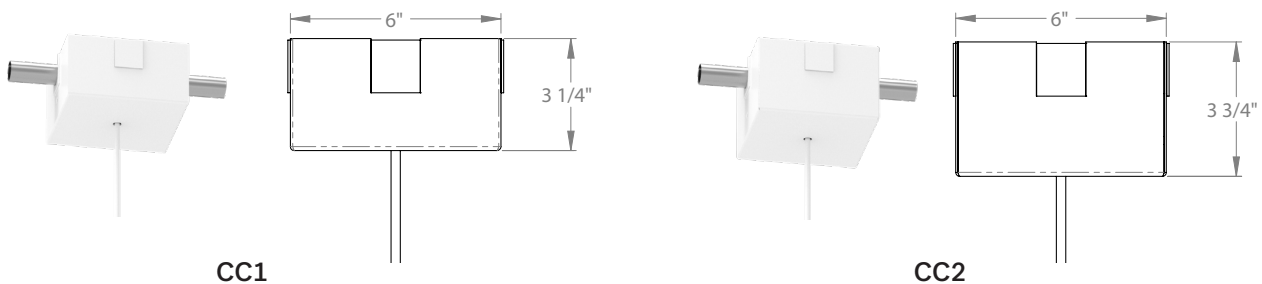

2", 3", 5" LED CYLINDER - PENDANT

5" ROUND CYLINDER

LP5 (5" Round Cylinder Downlight - Pendant Stem Mount)

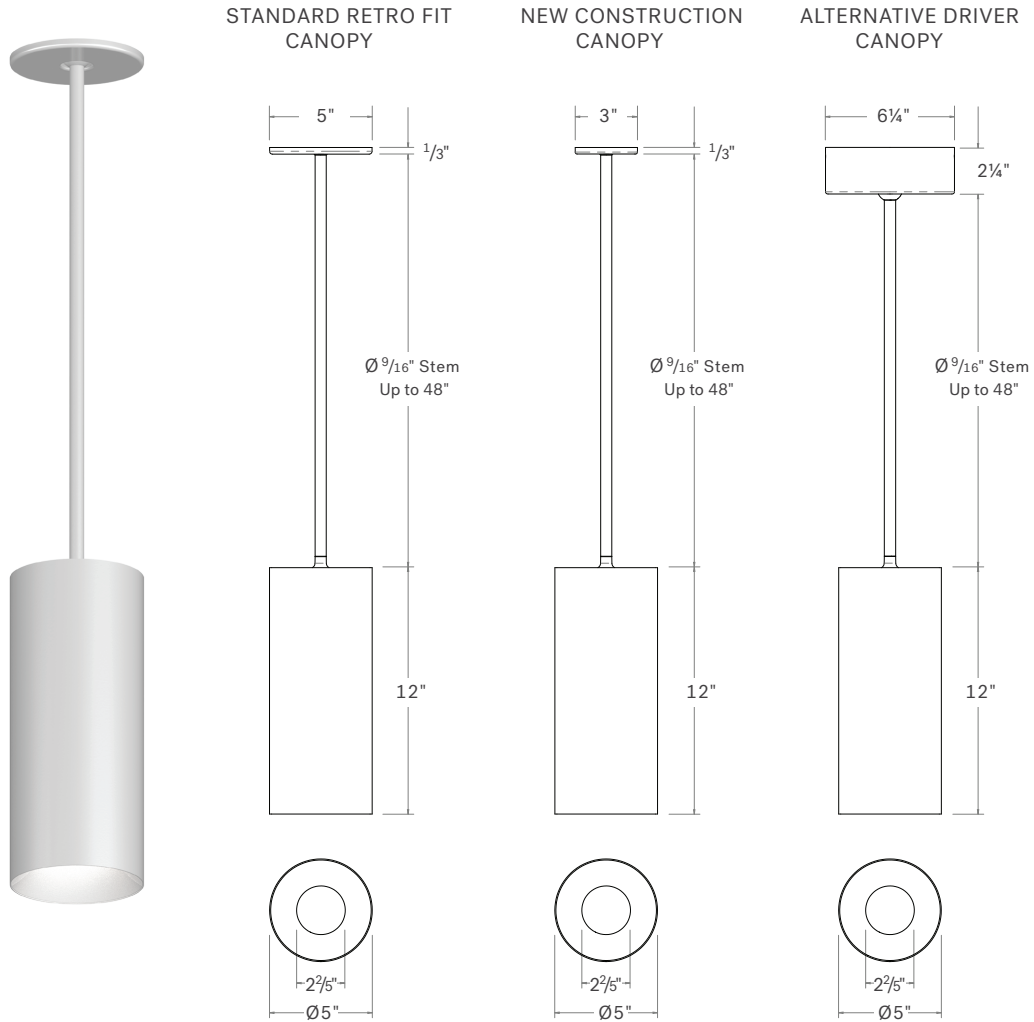

LP5 Stem Mount with CC1 and CC2 Conduit Canopy:

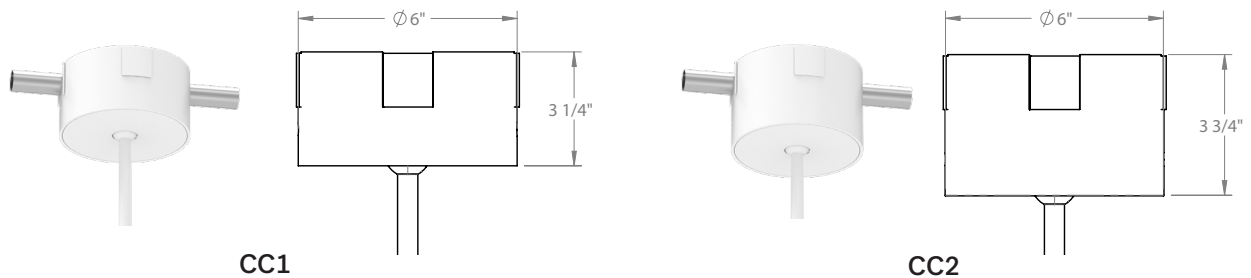

Project: _____
 Type: _____
 Note: _____

2", 3", 5" LED CYLINDER - PENDANT

5" ROUND CYLINDER

LP5 (5" Round Cylinder Downlight - Pendant Cord Mount)

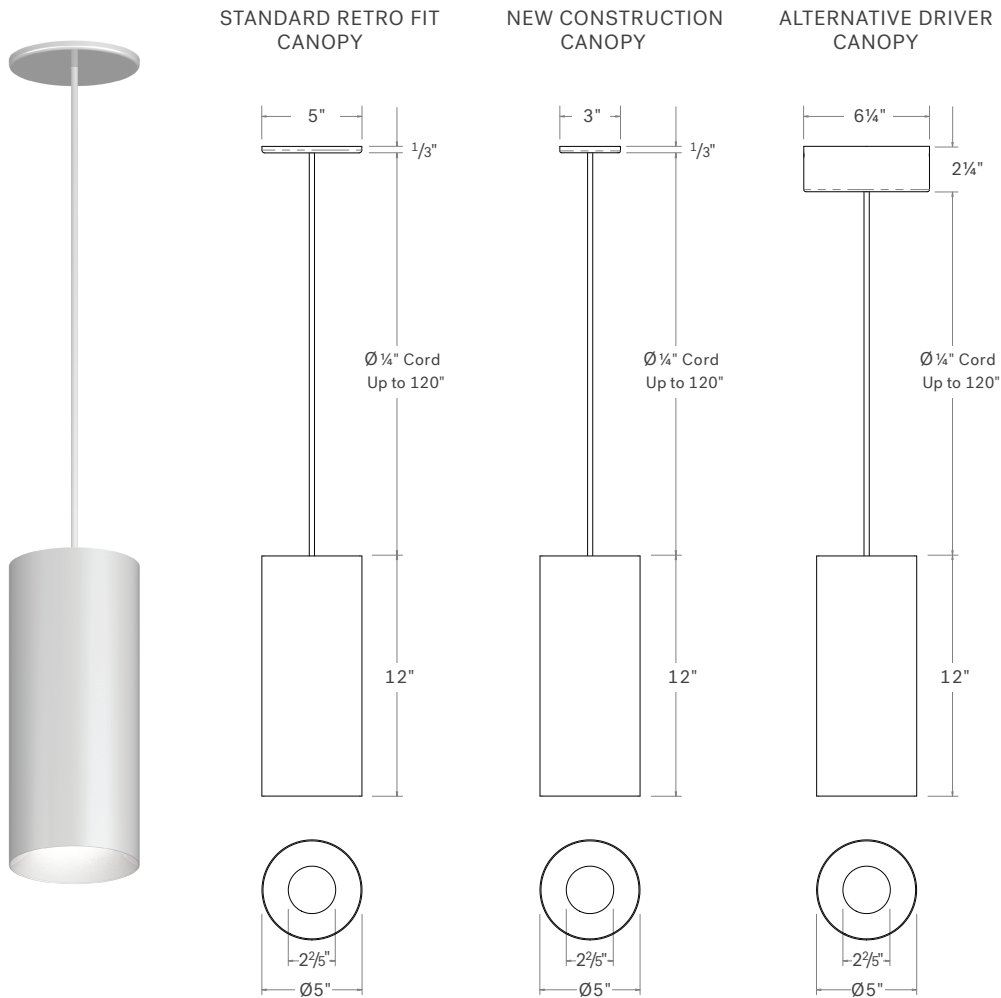

LP5 Cord Mount with CC1 and CC2 Conduit Canopy:

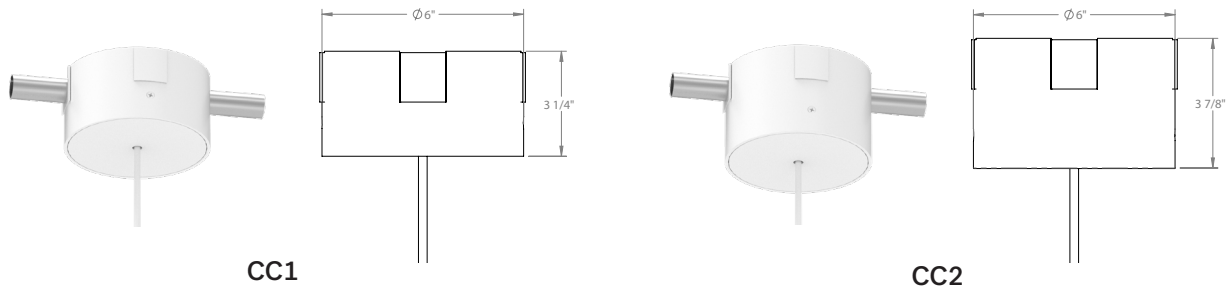

Project: _____
 Type: _____
 Note: _____

2", 3", 5" LED CYLINDER - PENDANT

5" SQUARE CYLINDER

SLP5 (5" Square Cylinder Downlight - Pendant Stem Mount)

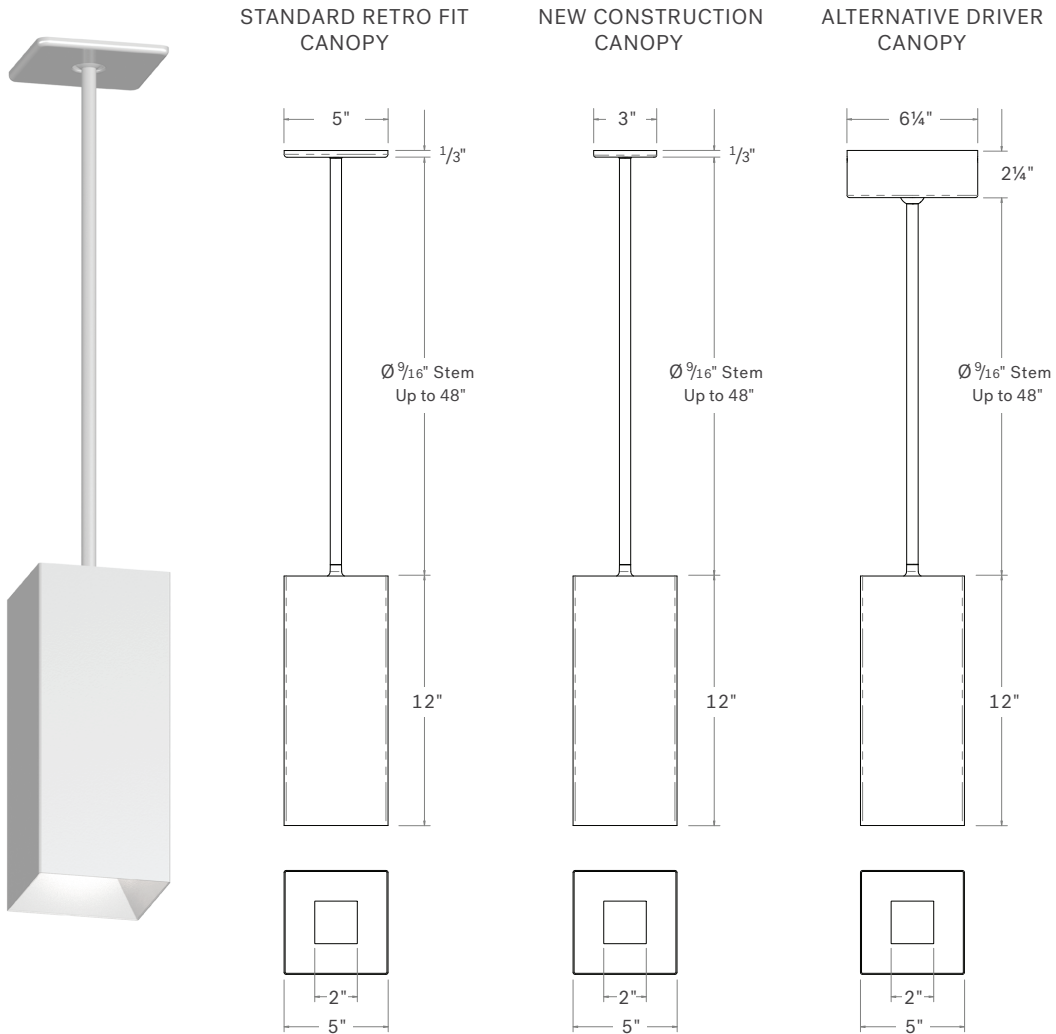

SLP5 Stem Mount with CC1 and CC2 Conduit Canopy:

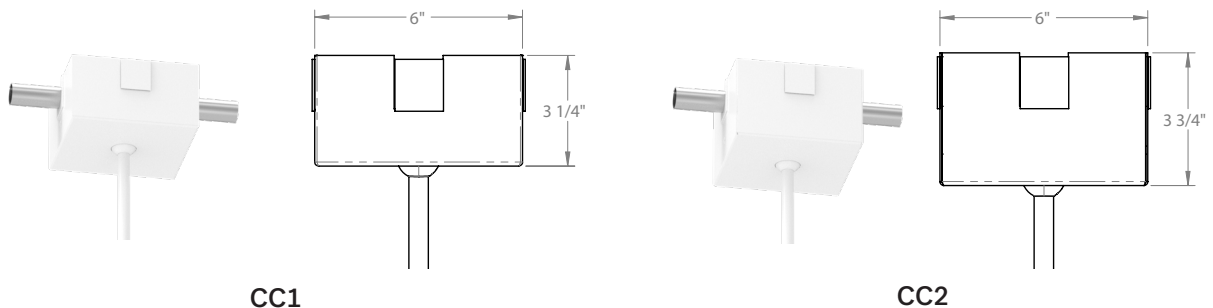

Project: _____
 Type: _____
 Note: _____

2", 3", 5" LED CYLINDER - PENDANT

5" SQUARE CYLINDER

SLP5 (5" Square Cylinder Downlight - Cord Stem Mount)

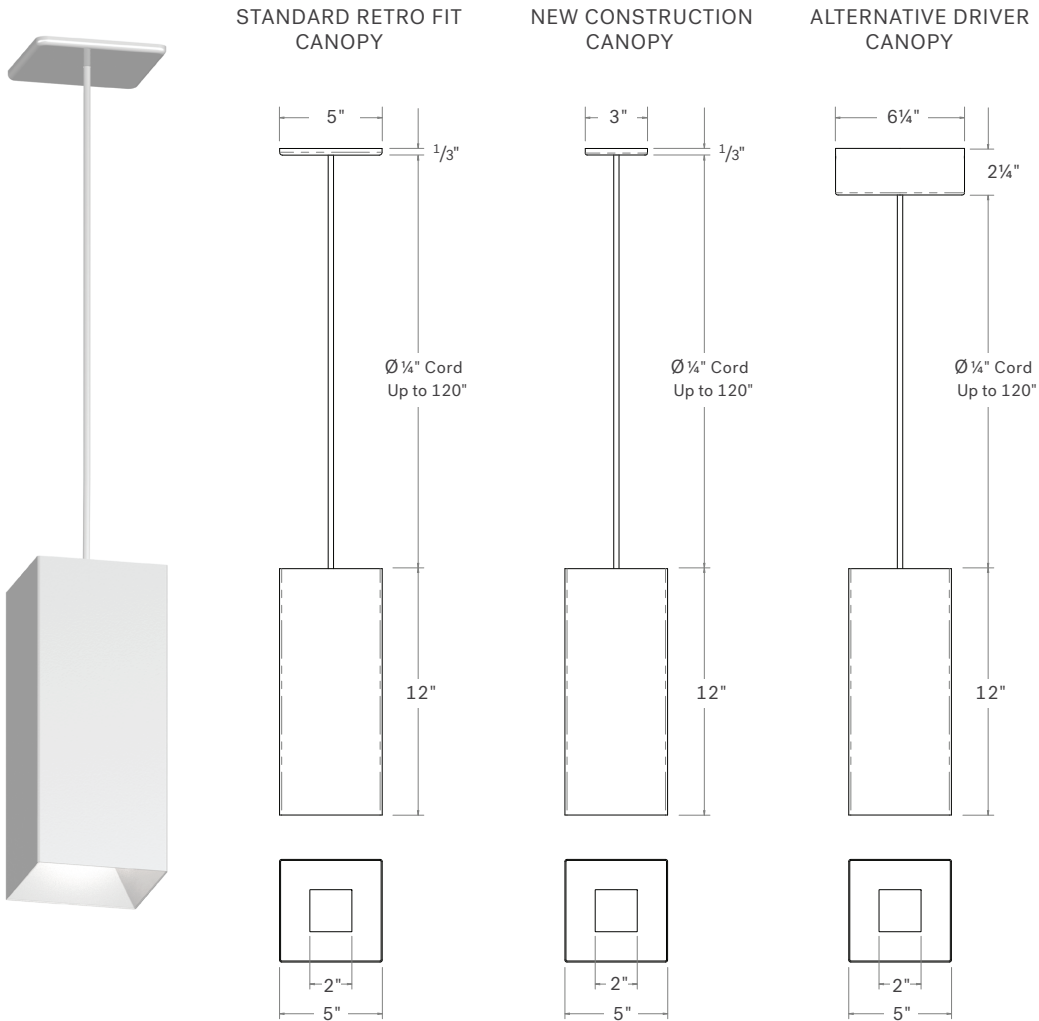

SLP5 Cord Mount with CC1 and CC2 Conduit Canopy:

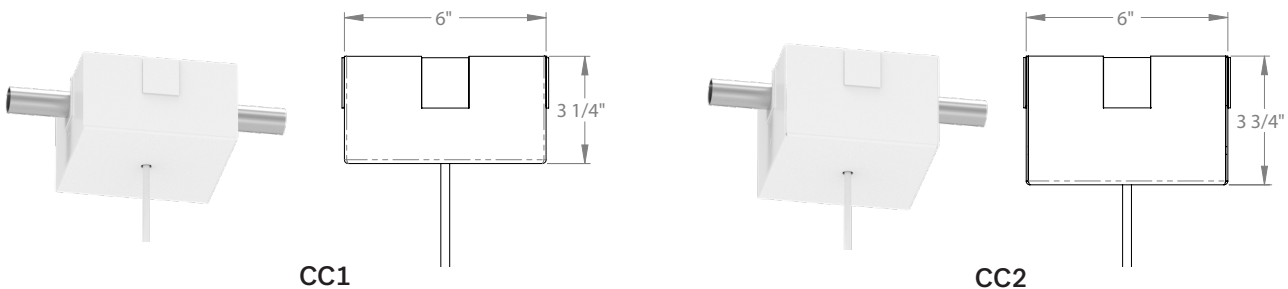

2", 3", 5" LED CYLINDER - PENDANT

HANGING OPTION (Round Stem Mount)



ST
Standard Retro Fit
Stem



NCST
New Construction
Stem



Alternative Driver
Stem

HANGING OPTION (Round Cord Mount)



WC
Retro Fit
White Cord



BC
Retro Fit
Black Cord



NCWC
New Construction
White Cord



NCBC
New Construction
Black Cord



Alternative Driver
White Cord

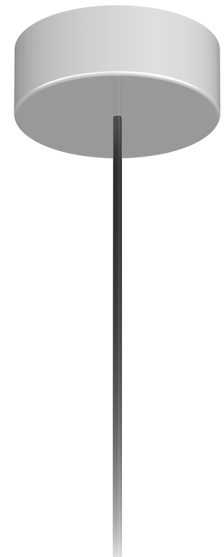

Alternative Driver
Black Cord

2", 3", 5" LED CYLINDER - PENDANT

HANGING OPTION (Square Stem Mount)



ST
Retro Fit
Stem



NCST
New Construction
Stem



Alternative Driver
Stem

HANGING OPTION (Square Cord Mount)



WC
Retro Fit
White Cord



BC
Retro Fit
Black Cord



NCWC
New Construction
White Cord



NCBC
New Construction
Black Cord



Alternative Driver
White Cord

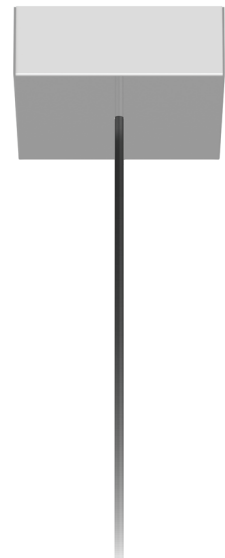

Alternative Driver
Black Cord

2", 3", 5" LED CYLINDER - PENDANT

PHOTOMETRICS

2" Cylinder (2700K, 90 CRI, 20W) 10° Optic

Polar Plot

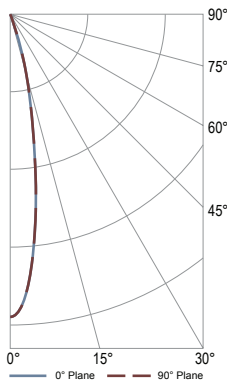

Cone of Light Tabulation

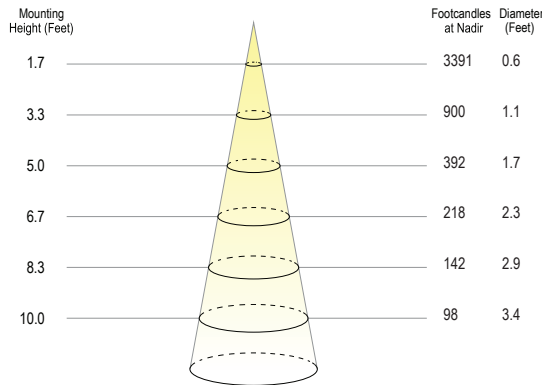

VOLTAGE	CURRENT	POWER
119.97 VAC	0.17945 A	21.38W

POWER FACTOR	FREQUENCY	CURRENT THD
0.993	60 Hz	9.3%

Summary of Results

Spacing Criteria	Total Lumen Output:	1407.3 Lumens
0-180: 0.34	Luminaire Efficacy:	65.8 lm/w
90-270: 0.34	Maximum Candela:	9800 Candela

ZONE	LUMENS	% OF LUMINAIRE
0-40	1404.2	98.8%
0-60	1417.42	99.7%
0-90	1421.67	100%

2" Cylinder (2700K, 90 CRI, 20W) 30° Optic

Polar Plot

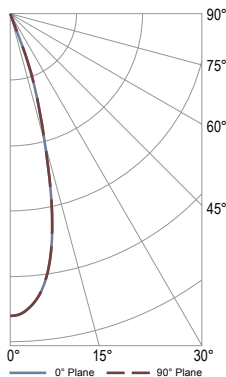

Cone of Light Tabulation

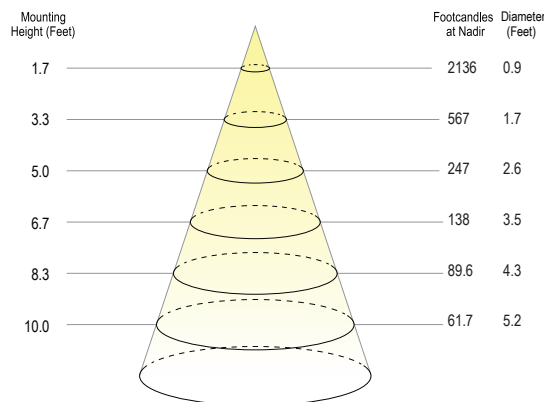

VOLTAGE	CURRENT	POWER
119.97 VAC	0.1796A	21.4W

POWER FACTOR	FREQUENCY	CURRENT THD
0.993	60 Hz	9.2%

Summary of Results

Spacing Criteria	Total Lumen Output:	1501.9 Lumens
0-180: 0.50	Luminaire Efficacy:	70.2 lm/w
90-270: 0.50	Maximum Candela:	6174 Candela

ZONE	LUMENS	% OF LUMINAIRE
0-40	1493.77	98.9%
0-60	1507.81	99.8%
0-90	1510.9	100%

2", 3", 5" LED CYLINDER - PENDANT

PHOTOMETRICS

2" Cylinder (2700K, 90 CRI, 20W) 50° Optic

Polar Plot

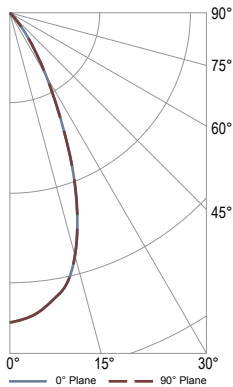

Cone of Light Tabulation

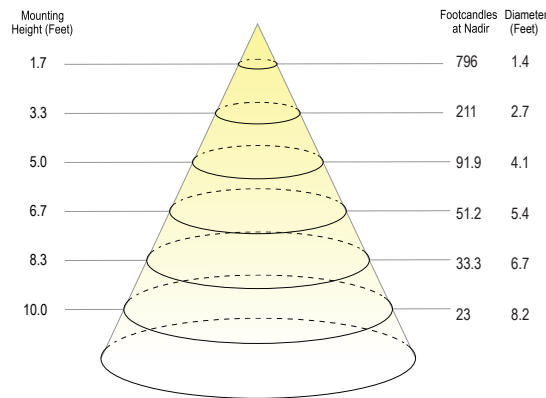

VOLTAGE	CURRENT	POWER
119.97 VAC	0.1796 A	21.41W

POWER FACTOR	FREQUENCY	CURRENT THD
0.993	60 Hz	9.1%

Summary of Results

Spacing Criteria	Total Lumen Output:	1385.6 Lumens
0-180: 0.72	Luminaire Efficacy:	64.7 lm/w
90-270: 0.74	Maximum Candela:	2297 Candela

ZONE	LUMENS	% OF LUMINAIRE
0-40	1310.37	94.4%
0-60	1384.27	99.7%
0-90	1385.6	100%

2" Cylinder (2700K, 90 CRI, 20W) 80° Optic

Polar Plot

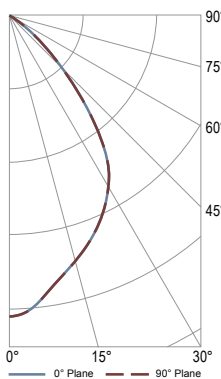

Cone of Light Tabulation

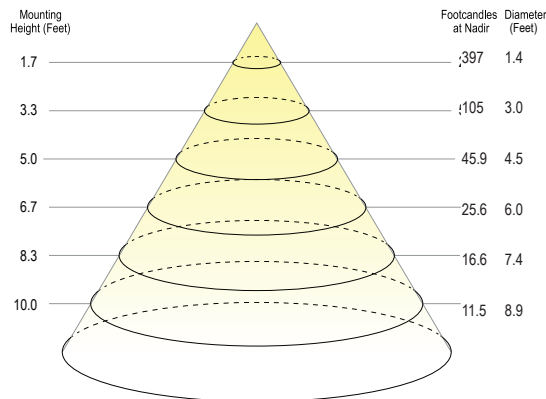

VOLTAGE	CURRENT	POWER
119.97 VAC	0.1795A	21.39W

POWER FACTOR	FREQUENCY	CURRENT THD
0.993	60 Hz	9.1%

Summary of Results

Spacing Criteria	Total Lumen Output:	1170 Lumens
0-180: 1.36	Luminaire Efficacy:	57 lm/w
90-270: 1.38	Maximum Candela:	755 Candela

ZONE	LUMENS	% OF LUMINAIRE
0-40	903.62	77.2%
0-60	1157.25	98.9%
0-90	1170	100%

Project: _____

Type: _____

Note: _____

2", 3", 5" LED CYLINDER - PENDANT

DIMMING DRIVER COMPATIBILITY

"S" STANDARD UNIVERSAL DIM

COMPATIBLE PHASE CUT DIMMER	
MANUFACTURER	PRODUCT
Cooper	DAL06P
	DLC03P
	SLC03P
Leviton	6161
	6631-2
	6633-P
	6673-10W
	6683-IW
	IPE04
	IPI06-1LZ
	VPE06
Lightolier	ZP26QEW
Lutron	CT103P
	DV600P
	DVCL-153P
	DVEL303P
	FAELV500
	LG600P
	MAELV600
	S600P
	S-603PG
	SELV300P
	TG-600P
	TGCL-153P

COMPATIBLE 1-10V DIMMER	
MANUFACTURER	PRODUCT
Leviton	IP740-DLZ
Lightolier	ZP600FAM120
	V2000FAMU
Lutron	DVTV
	NTFTV
Crestron	CLS-EXP-DIMFLV
	DIN-4DIMFLV4
	DIN-A08
	GLX-DIMFLV8

Project: _____
 Type: _____
 Note: _____

2", 3", 5" LED CYLINDER - PENDANT

DIMMING DRIVER COMPATIBILITY

DIMMER LIST

"L3" LUTRON FADE-TO-BLACK

DIMMER INFORMATION	
MANUFACTURER	PRODUCT
Lutron	LQSE-2ECO-D
	RMJ-ECO32-DV-B
	FCJ/FCJS-ECO
	QSN-1ECO-S
	QSN-2ECO-S
	EcoSystem ESN
	Grafik Eye QS with EcoSystem
	Quantum

NOTE: Wiring diagrams are examples of typical installations intended to illustrate the number of wires that must be run to fixture. These diagrams are not intended to specify all equipment necessary for a given dimming circuit. Refer to specific dimmer manufacturer's documentation for details.

L3- LUTRON FADE-TO-BLACK DRIVER EcoSystem DIMMING

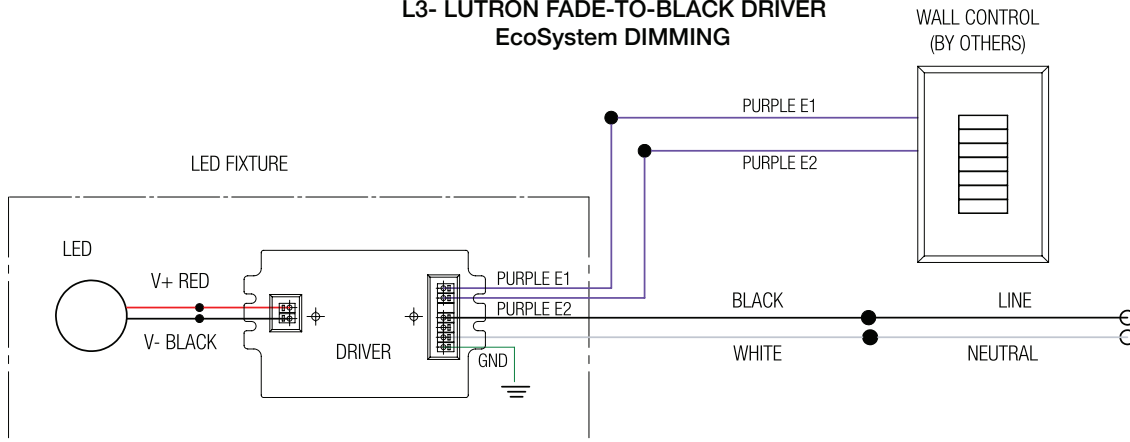

IMPORTANT SAFETY INSTRUCTIONS - SAVE THESE INSTRUCTIONS

1. Keep these instructions in a safe place for future reference.
2. Only qualified electricians in accordance to local codes should install these fixtures
3. De-energize the electrical circuit at the circuit breaker prior to installation process or servicing.
4. Make sure all connections are in accordance with the National Electrical Code and any local regulations.
5. Cap any wires not used separately (not together).

2", 3", 5" LED CYLINDER - PENDANT

DIMMING DRIVER COMPATIBILITY

DIMMER LIST

"EL1" eldoLED DALI 1%

DIMMER INFORMATION	
MANUFACTURER	PRODUCT
	DALI Controls

NOTE: Wiring diagrams are examples of typical installations intended to illustrate the number of wires that must be run to fixture. These diagrams are not intended to specify all equipment necessary for a given dimming circuit. Refer to specific dimmer manufacturer's documentation for details.

EL1- eldoLED DRIVER DALI DIMMING

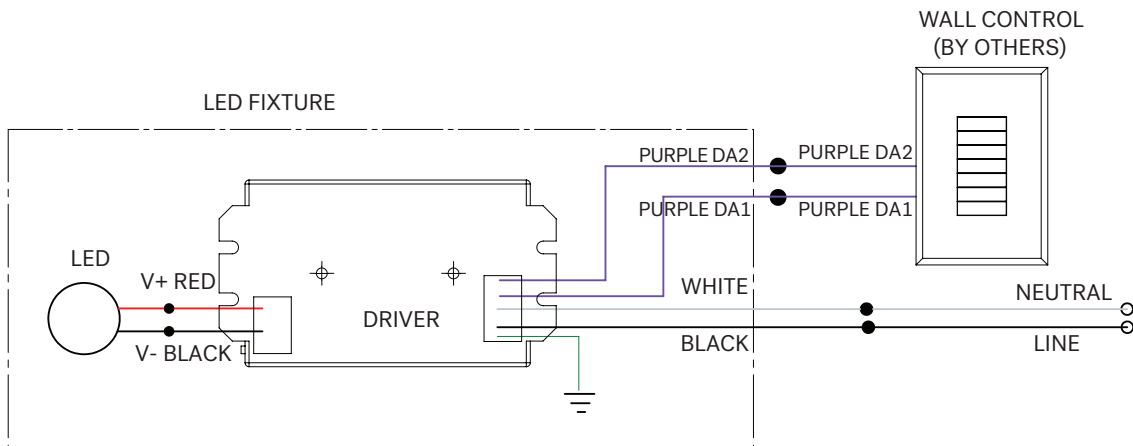

IMPORTANT SAFETY INSTRUCTIONS - SAVE THESE INSTRUCTIONS

1. Keep these instructions in a safe place for future reference.
2. Only qualified electricians in accordance to local codes should install these fixtures
3. De-energize the electrical circuit at the circuit breaker prior to installation process or servicing.
4. Make sure all connections are in accordance with the National Electrical Code and any local regulations.
5. Cap any wires not used separately (not together).

Project: _____
 Type: _____
 Note: _____

2", 3", 5" LED CYLINDER - PENDANT

DIMMING DRIVER COMPATIBILITY

DIMMER LIST

"EL2" eLdoLED 0-10V 1%

DIMMER INFORMATION	
MANUFACTURER	PRODUCT
Leviton	IP740-DLZ
Lightolier	ZP600FAM120
Lutron	DVTV
	NTFTV
	NFTV
Crestron	CLS-EXP-DIMFLV
	DIN-4DIMFLV4
	DIN-A08
	GLX-DIMFLV8

NOTE: Wiring diagrams are examples of typical installations intended to illustrate the number of wires that must be run to fixture. These diagrams are not intended to specify all equipment necessary for a given dimming circuit. Refer to specific dimmer manufacturer's documentation for details.

EL2- eLdoLED DRIVER 0-10V DIMMING

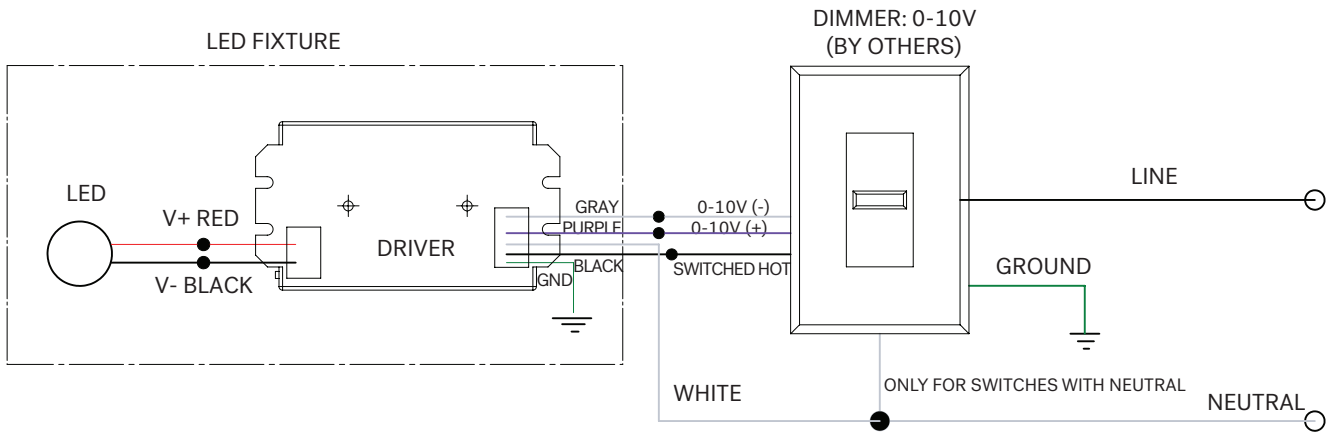

IMPORTANT SAFETY INSTRUCTIONS - SAVE THESE INSTRUCTIONS

1. Keep these instructions in a safe place for future reference.
2. Only qualified electricians in accordance with local codes should install these fixtures
3. De-energize the electrical circuit at the circuit breaker prior to installation process or servicing.
4. Make sure all connections are in accordance with the National Electrical Code and any local regulations.
5. Cap any wires not used separately (not together).

2", 3", 5" LED CYLINDER - PENDANT

DIMMING DRIVER COMPATIBILITY

DIMMER LIST

"DMX" Moons

DIMMER INFORMATION	
MANUFACTURER	PRODUCT
	DMX Controls

NOTE: Wiring diagrams are examples of typical installations intended to illustrate the number of wires that must be run to fixture. These diagrams are not intended to specify all equipment necessary for a given dimming circuit. Refer to specific dimmer manufacturer's documentation for details.

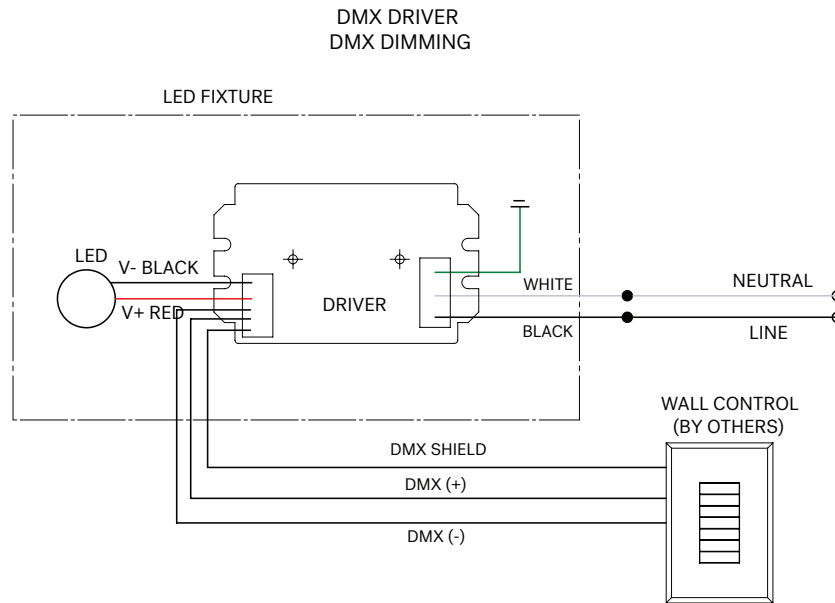

IMPORTANT SAFETY INSTRUCTIONS - SAVE THESE INSTRUCTIONS

1. Keep these instructions in a safe place for future reference.
2. Only qualified electricians in accordance to local codes should install these fixtures
3. De-energize the electrical circuit at the circuit breaker prior to installation process or servicing.
4. Make sure all connections are in accordance with the National Electrical Code and any local regulations.
5. Cap any wires not used separately (not together).