

Contemporary Lever Installation Instructions



L00-YV00M14 Rev. 13/11-02

USE AND CARE GUIDE GUIDE D'UTILISATION ET D'ENTRETIEN GUÍA DE USO Y CUIDADOS

1 FOR POUR PARA

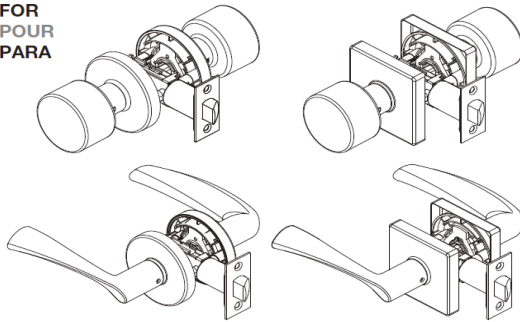

2 Safety Information Informations de sécurité Información de seguridad

Read the precautions and instructions in this manual before installing and using this lock. Save this manual for future reference.

Lisez les consignes et instructions contenues dans le présent manuel avant d'installer et d'utiliser cette serrure. Conservez ce manuel pour consultation ultérieure.

Lea las advertencias e instrucciones en este manual antes de instalar y usar esta cerradura. Guarde este manual para consultas futuras.



WARNING/AVERTISSEMENT/ADVERTENCIA:

If the door needs to be drilled, be familiar with how to use your drill safely, and understand all the door preparation steps before proceeding.

S'il faut percer la porte, sachez comment utiliser adéquatement votre perceuse et assurez-vous que vous connaissez toutes les étapes de préparation de la porte avant de continuer.

Si debe perforar la puerta, sepa cómo usar su taladro con seguridad, y entienda todos los pasos de preparación de la puerta antes de proceder.



CAUTION/ATTENTION/ADVERTENCIA:

Before beginning the installation, please read and understand the entire manual.

Avant de continuer l'installation, veuillez lire et comprendre tout le manuel.

Antes de comenzar la instalación, lea y entienda todo el manual.



NOTE/REMARQUE/NOTA:

To ensure a long lasting finish, remove the locks, or do not install the locks, prior to painting your door. Periodically clean the locks with mild soap and a soft cloth. Do not use abrasives or harsh chemicals, and avoid sharp or scratching objects.

Pour assurer un fini durable, retirez les serrures, ou ne les installez avant de peindre votre porte. Nettoyez régulièrement les serrures avec un savon doux et un chiffon doux. Évitez les produits abrasifs ou chimiques agressifs, et évitez les objets pointus ou susceptibles de gratter.

Para garantizar un acabado de larga duración, retire las cerraduras, o no instale una cerradura, antes de pintar la puerta. Limpie las cerraduras periódicamente con jabón y paño suaves. No use productos químicos abrasivos o agresivos, y evite los objetos afilados o que puedan causar rayones.

3 Pre-Installation – Tools Required/Hardware Included Pré-installation – Outils nécessaires /matériel inclus Instalación previa – Herramientas necesarias/Hardware incluido

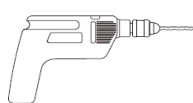
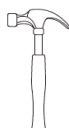

Optional
Facultatif
Opcional

Optional
Facultatif
Opcional

Optional
Facultatif
Opcional

Part Pièce Parte	Description Description Descripción	Quantity Quantité Cantidad
AA	Mounting Screws / Vis de fixation / Tornillos de montaje	2
BB	Latch/Strike Plate Screws / Vis de la plaque de la serrure/gâche / Tornillos del cerrojo/cerradero	4
CC	Allen wrench / Clé hexagonale / Llave Allen	1
DD	Set screw / Vis de serrage / Tornillo de fijación	2



Note: Not to scale.

Remarque: Pas à l'échelle.

Nota: No está a escala.



AA



BB



CC



DD

Part Pièce Parte	Description Description Descripción	Quantity Quantité Cantidad
A	Interior lever / Levier intérieur / Palanca interior	1
B	Interior rose / Rose intérieur / Roseta interior	1
C	Interior rose plate / Plaque rose intérieur / Placa de la roseta interior	1
D	Latch / Serrure / Pestillo	1
E	Faceplate / Plaque de frontale / Placa frontal	1
F	Strike Plate / Gâche / Cerradero	1
G	Interior rose plate / Plaque rose intérieur / Placa de la roseta interior	1
H	Exterior lever / Levier extérieur / Palanca exterior	1
J	Inside square plate / Plaque carrée interne / Disco cuadrado interior	1

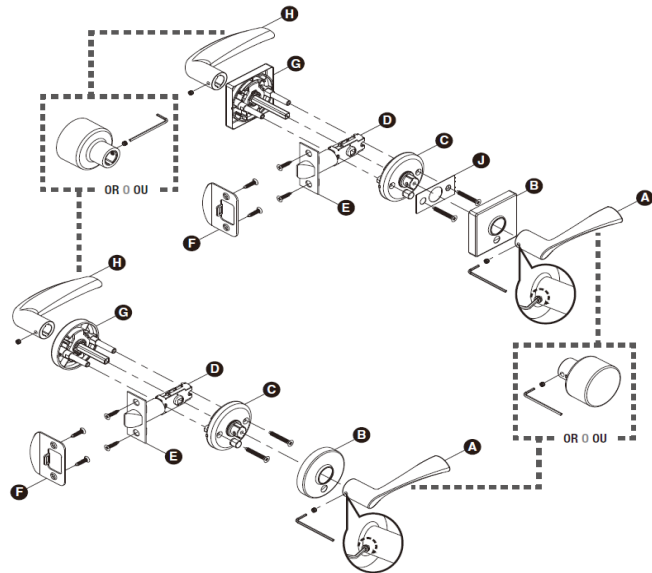

4 Pre-Installation (continued) – Door Preparation Pré-installation (suite) – Préparation de la porte Antes de la instalación (continuación) – Preparación de la puerta



NOTE: If your door already has holes, skip to installation.

REMARQUE: Si votre porte a déjà des trous, passez à l'installation.

NOTA: Si su puerta ya tiene agujeros, pase a la instalación.

1

Using the template, mark the door and drill the holes, and chisel out a mortise.

À l'aide du modèle, marquez la porte et percez et ciselez une mortaise.

Con la plantilla, marque la puerta y perforo los orificios, y cincela las muescas.



NOTE: Drill from both sides to avoid wood splitting.

REMARQUE: Percez des deux côtés pour éviter l'éclatement du bois.

NOTA: Perfore de ambos lados para evitar dañar la madera.

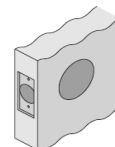
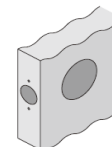
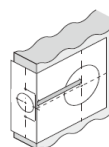

2

Prepare the door jamb – using the strike plate as a pattern, drill the latch and screw holes, and chisel out a mortise until the strike plate fits flush.

Préparez le jambage de la porte – à l'aide de la gâche comme modèle, percez les trous de la serrure et de la vis, ciselez une mortaise jusqu'à ce que la gâche puisse entrer sans force.

Prepara el portante de la puerta: usando el cerradero como plantilla, perforo los orificios de la cerradura y el cerradero, y cincela una muesca hasta que el cerradero entre perfectamente.



NOTE: To assure proper lockset function, the holes in the door jamb must be drilled 1/2 in. (13 mm) deep.

REMARQUE: Pour assurer un bon fonctionnement de la serrure complète, les trous sur le jambage de la porte doit être percé de 1/2 pouce, (13 mm) de profondeur.

NOTA: Para garantizar un funcionamiento adecuado del juego de cerradura, debe perforar los orificios del portante de la puerta hasta una profundidad de 1/2 pulgada (13 mm).

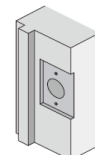

Contemporary Lever Installation Instructions



TEMPLATE MODÈLE PLANTILLA

Drill a 1" (25 mm) diameter hole at the center of the door edge.
Percez un trou de 1" dans le centre du rebord de la porte.
Hacer un agujero de 1" en el centro del borde de la puerta.

Fold here.
Place on the door edge.
Pliez ici.
Placez sur le rebord de la porte.
Doble aquí.
Ponga en el borde de la puerta.

Ø 2-1/8" (54 mm)

NOTE: Double check your product for the correct hole sizes.
REMARQUE: Vérifiez attentivement votre produit pour vous assurer que les tailles du trou sont correctes.
NOTA: Verifique nuevamente los tamaños correctos de los orificios para su producto.

1-3/4" (45 mm) 1-9/16" (40 mm) 1-3/8" (35 mm)

Backset
Distance d'entrée
Entrada 2-3/8" (60 mm)

Backset
Distance d'entrée
Entrada 2-3/4" (70 mm)

5 Installation Installation Instalación

1 INSTALLING THE LATCH INSTALLATION DE LA SERRURE INSTALACIÓN DEL PESTILLO

A. Attach the correct faceplate
Fixez la bonne plaque frontale
Coloque la placa frontal correcta

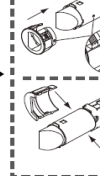
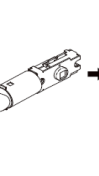
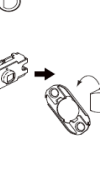
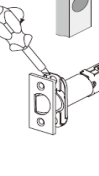
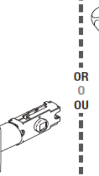
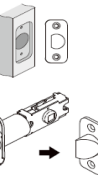
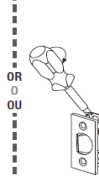
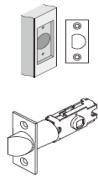

B. Set the latch backset
Réglez la distance d'entrée de la serrure
Fije la entrada del pestillo

CAUTION: Be sure the latch cam is upright before making any backset adjustment.
ATTENTION: Assurez-vous que la came de la gâche est droite en effectuant tous les ajustements nécessaires de la distance d'entrée.
ADVERTENCIA: Asegúrese de que la leva del pestillo está en posición vertical antes de ajustar la entrada.

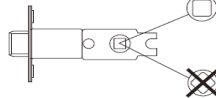

Right/Correct/Correcto

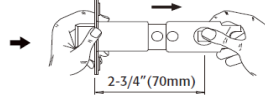

2-3/4" (70mm)

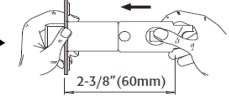

2-3/8" (60mm)

C. Install the latch
Installez la gâche
Instale el pestillo

NOTE: The bevel should face the door jamb.
REMARQUE: Le biseau doit faire face jambage de la porte.
NOTA: El bisel debe enfrentar al montante de la puerta.

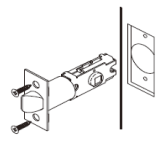

OR
OU

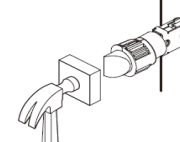

2 INSTALLING THE LEVERS INSTALLATION DES LEVIERS INSTALACIÓN DE LAS PALANCAS

A. Install the exterior lever
Installez le levier extérieur
Instale la palanca exterior

B. Install the interior lever
Installez le levier intérieur
Instale la palanca interior

Wrong/Incorrect/Equivocado
Mauvaise position

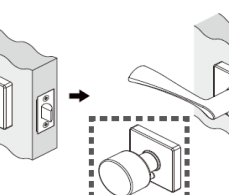
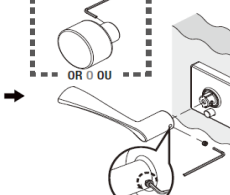
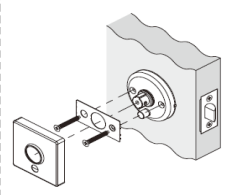
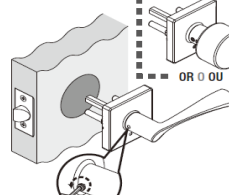
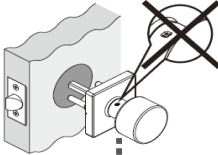

Wrong/Incorrect/Equivocado
Mauvaise position

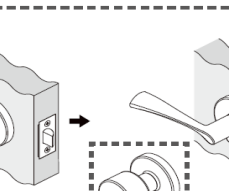
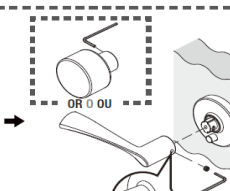
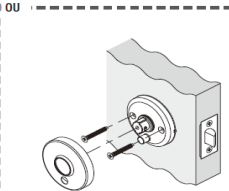
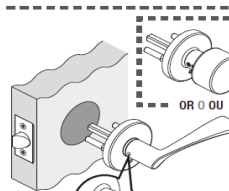

SWITCHING THE HANDLES (IF DESIRED) CHANGEMENT DES POIGNÉES (SI NÉCESSAIRE) CAMBIAR LAS MANIJAS (SI SE DESEA)

NOTE: Levers installed in reverse will not affect the product's performance.
REMARQUE: Les leviers installés dans l'ordre inverse n'affecteront pas la performance du produit.
NOTA: Las palancas instaladas a la inversa no afectan el desempeño del producto.

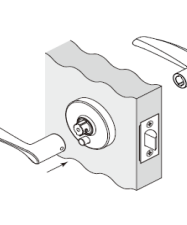
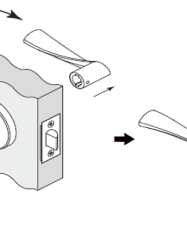
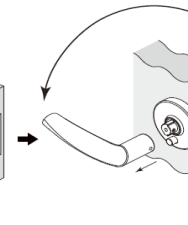
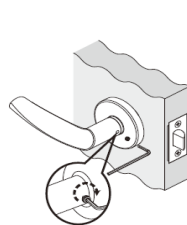
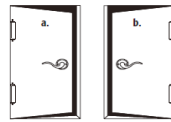

3 INSTALLING THE STRIKE PLATE INSTALLATION DE LA GÂCHE INSTALACIÓN DEL CERRADERO

NOTE: If required, bend the adjustable tang on the strike to eliminate a loose fit between the door and the door stop.
REMARQUE: Si nécessaire, pliez le tenon ajustable sur la gâche pour éliminer tout espace vide entre la porte et l'arrêt de la porte.
NOTA: Si es necesario, doblar la rabera ajustable sobre el cerradero para lograr un buen calce entre la puerta y el marco.

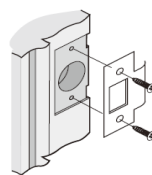

OR
OU

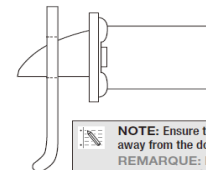
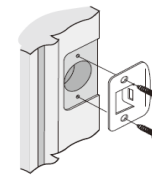

NOTE: Ensure the lip faces away from the door.
REMARQUE: Éloignez les faces les faces à ergot de la porte.
NOTA: Asegúrese de que el tablo esté en sentido opuesto a la puerta. away from the door.