



2100 South Clearwater Drive
Des Plaines, IL 60018
Phone: 847-803-5000
Fax: 847-803-5454
www.chicagofaucets.com

FOR TECHNICAL ASSISTANCE
1-800-TEC-TRUE (1-800-832-8783)

ROUGH-IN

BY: JAR DATE: 02-10-16
CHK: *JAR* REV:

FITTING NO.
EQ-A13-KJKCP EQ-A13-KJKBN
SUBMITTED MODEL NO.

SUBMITTED AS SHOWN	SUBMITTED AS NOTED	SEE ATTACHED FOR SUBMITTED MODIFICATION
JOB NAME		ITEM NO.

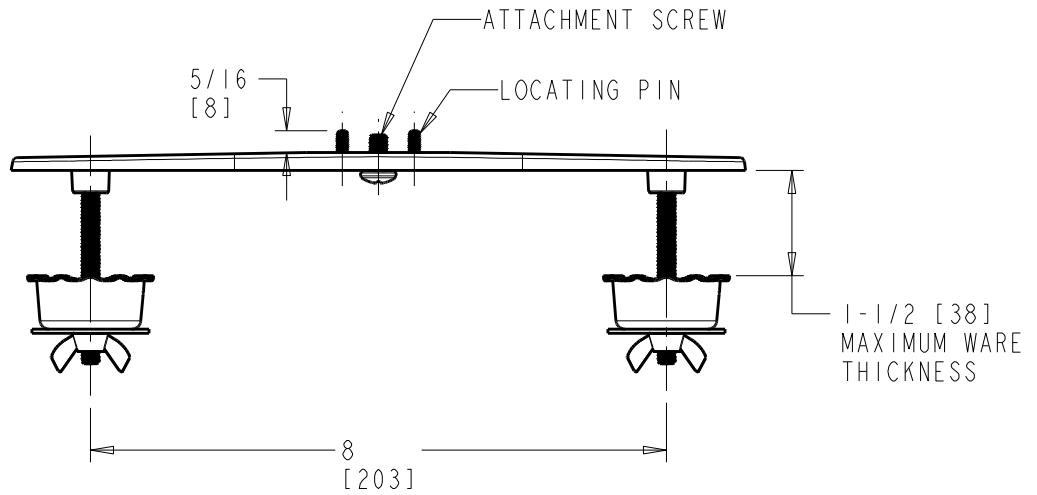
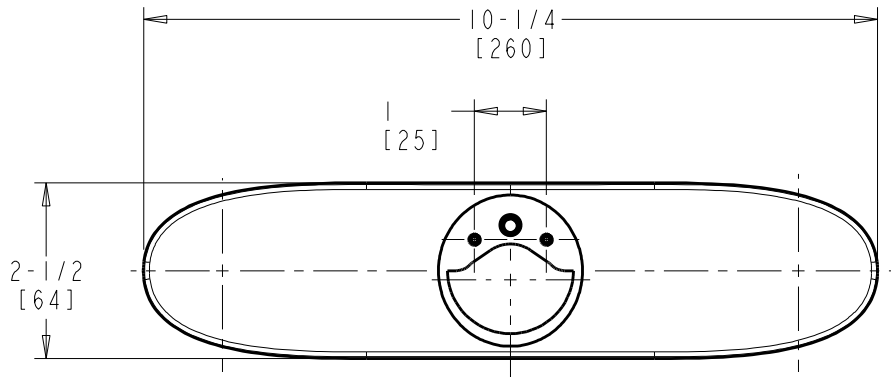

DIMENSIONS ARE IN INCHES AND [MILLIMETERS].

TECHNICAL DATA

- SEE SPECIFICATION SHEET

ROUGHING IN DIMENSIONS MAY VARY AND ARE SUBJECT TO CHANGE. NO RESPONSIBILITY IS ASSUMED FOR USE OF SUPERCEDED OR VOIDED DATA.