

Model# 80968-Z

Three Handle Tub & Shower Set

FEATURES & SPECIFICATIONS

- Canopy Handles
- Shower Head, Arm & Flange
- 1/2" I.P.S. or 1/2" nominal copper Union Inlets
- Ceramic Disc Cartridges
- 8" Centers
- 1/2" IPS & Slip-on Combo Tub Spout

FINISHES

- PC Polished Chrome

STANDARDS

- ASME A112.18.1



WARRANTY

- Lifetime Limited Warranty
- Lifetime Residential Warranty
- 5 Year Commercial Warranty

80968-Z/REV. 11 2016

Product Specifications subject to change without notice

Job Name _____ Date _____
Model Specified _____ QTY _____
Customer/Wholesaler _____
Contractor _____
Architect/Engineer _____
Submitted as Shown _____
Submitted w/ Variations _____

Model# 80968-Z

Three Handle Tub & Shower Set

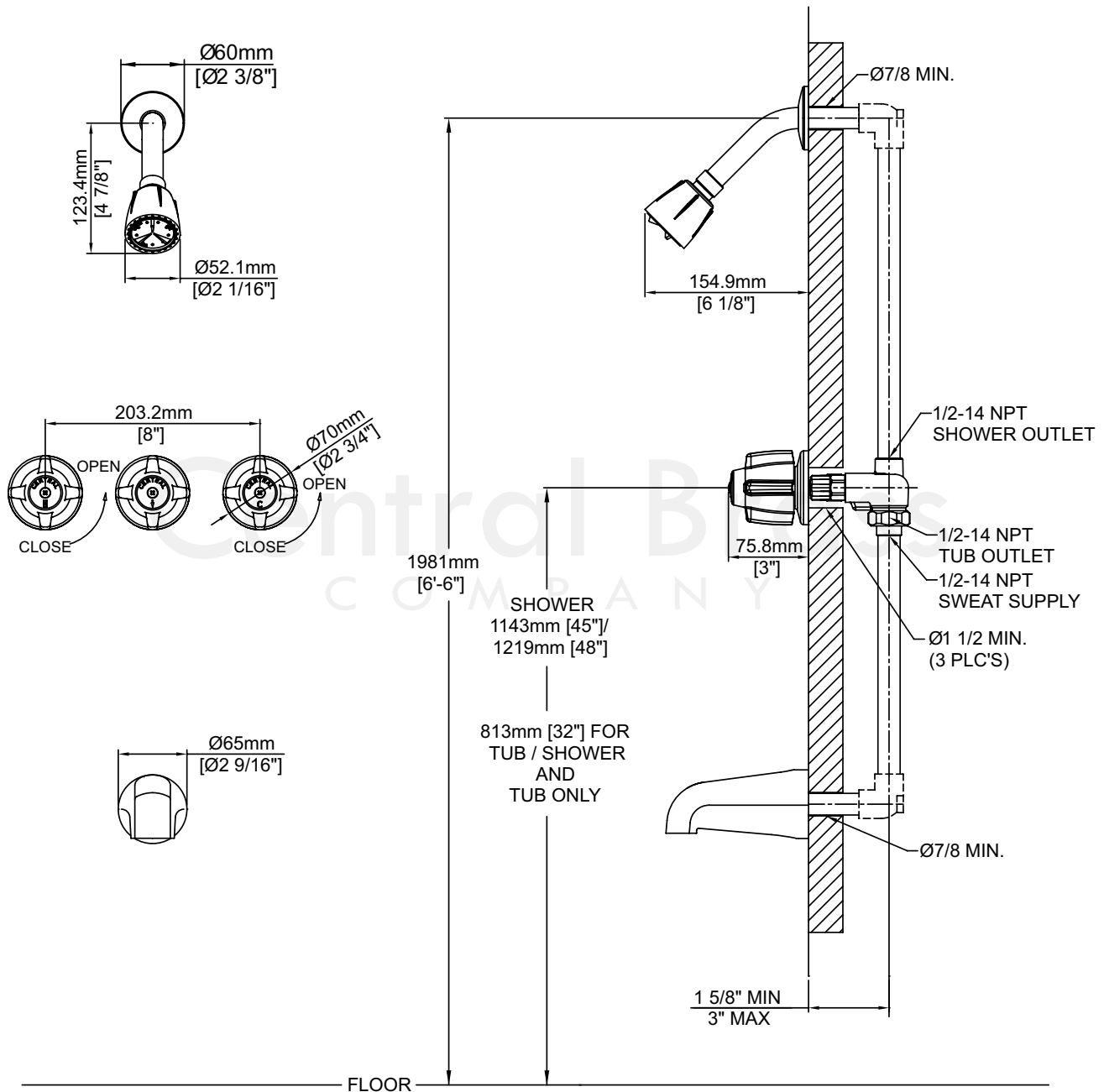

80968-Z/REV. 11 2016

Product Specifications subject to change without notice