

Model# 0336-N2-3/8

Slow-Close Straight Stop

FEATURES & SPECIFICATIONS

- Push Handle
- 3/8-18 NPS Female Thread

FINISHES

- PC Polished Chrome

STANDARDS

- ASME A112.18.1



WARRANTY

- Lifetime Limited Warranty
- Lifetime Residential Warranty
- 5 Year Commercial Warranty

0336-N2-3/8/REV. 11 2016

Product Specifications subject to change without notice

Job Name _____ Date _____
Model Specified _____ QTY _____
Customer/Wholesaler _____
Contractor _____
Architect/Engineer _____
Submitted as Shown _____
Submitted w/ Variations _____

Model# 0336-N2-3/8

Slow-Close Straight Stop

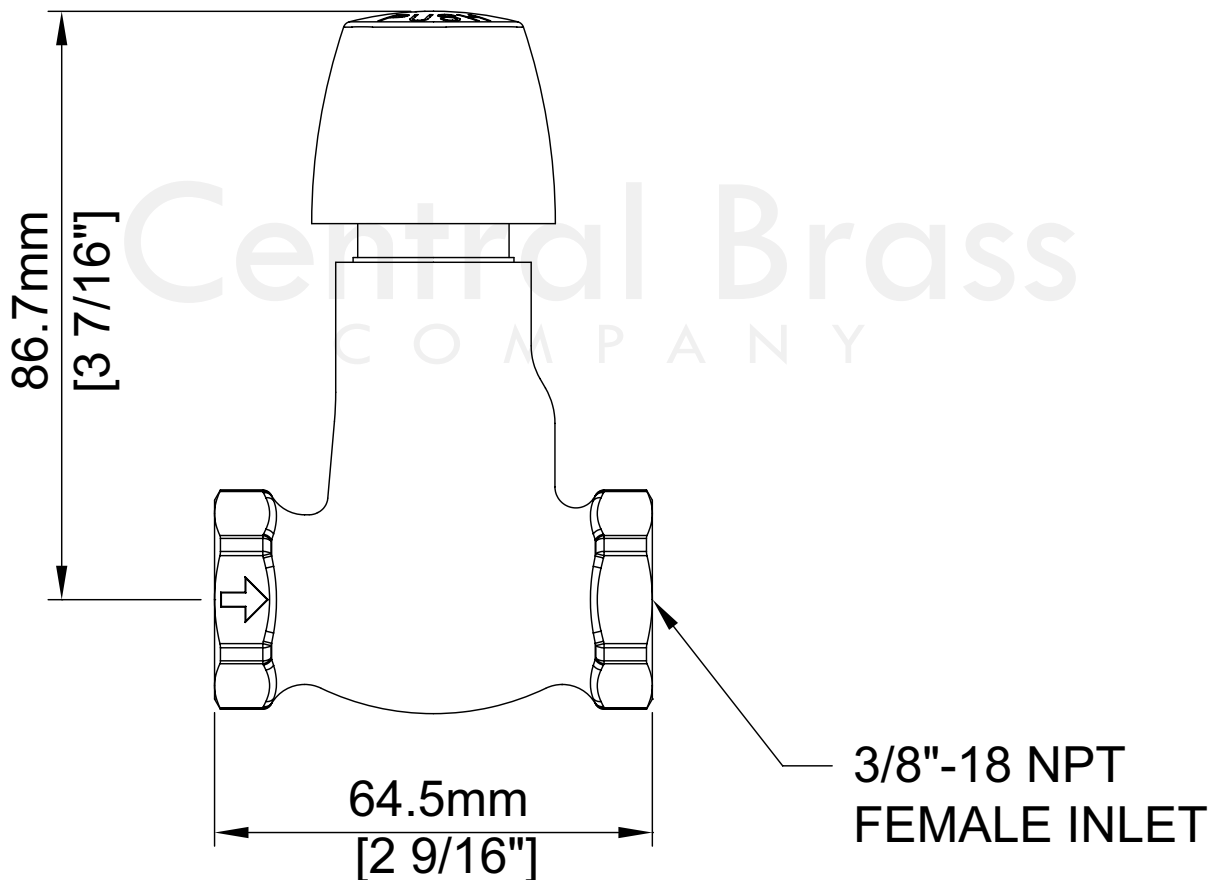
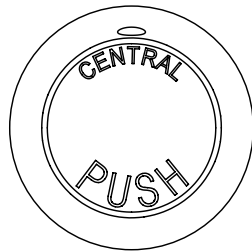

0336-N2-3/8/REV. 11 2016

Product Specifications subject to change without notice