

Model# 0208

Two Handle Leg Tub Faucet

FEATURES & SPECIFICATIONS

- Canopy Handles
- 6-7/8" High Gooseneck Spout
- 3/4-14 NPS Male Inlets
- Replaceable Seat
- 2-Hole 3-3/8" Installation

FINISHES

- PC Polished Chrome

STANDARDS

- ASME A112.18.1
- ANSI A117.1 / ADA COMPLIANT



WARRANTY

- Lifetime Limited Warranty
- Lifetime Residential Warranty
- 5 Year Commercial Warranty

0208/REV. 11 2016

Product Specifications subject to change without notice

Job Name _____ Date _____
Model Specified _____ QTY _____
Customer/Wholesaler _____
Contractor _____
Architect/Engineer _____
Submitted as Shown _____
Submitted w/ Variations _____

Model# 0208

Two Handle Leg Tub Faucet

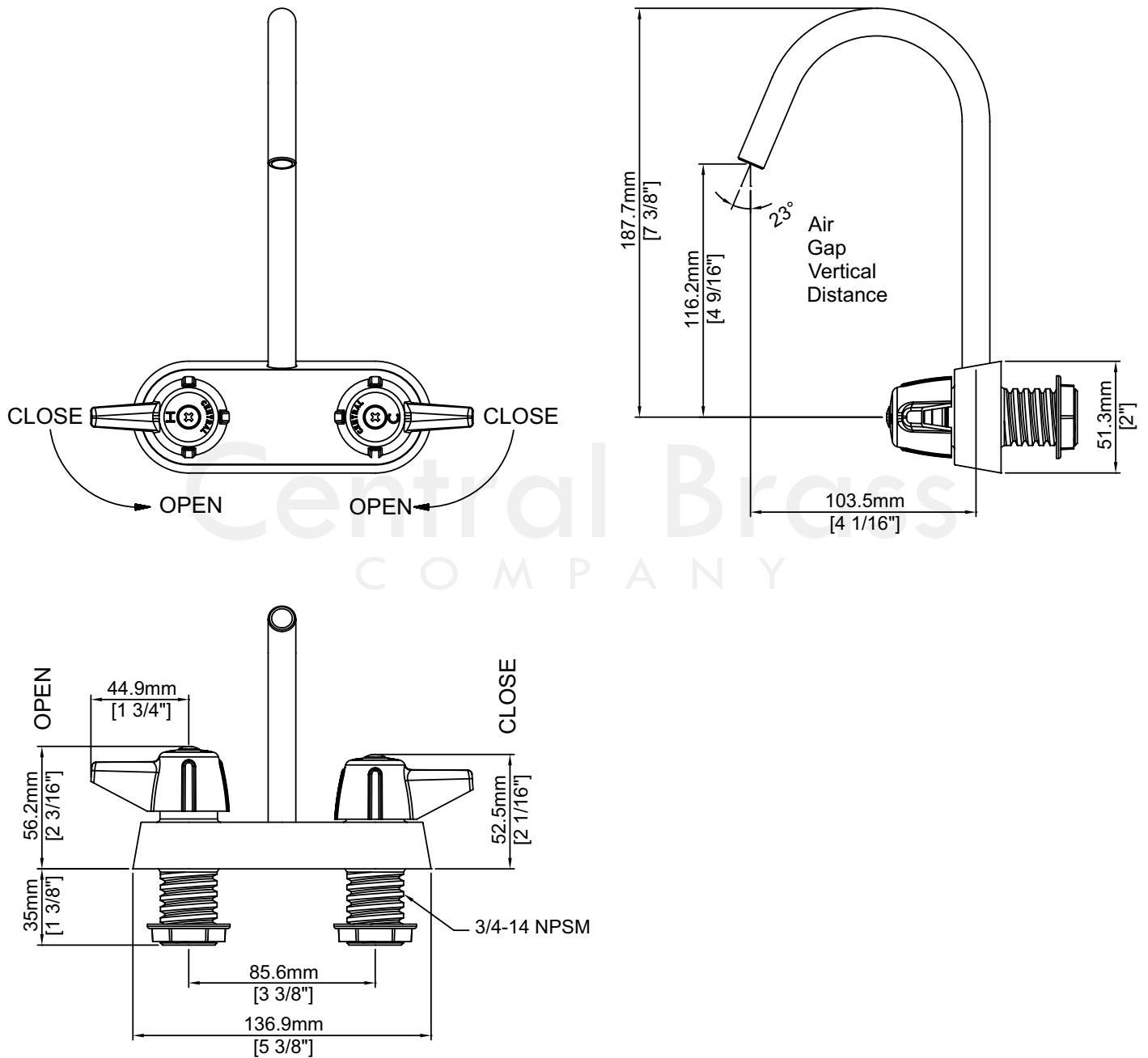

0208/REV. 11 2016

Product Specifications subject to change without notice