

Model# 80968

Three Handle Tub & Shower Set

FEATURES & SPECIFICATIONS

- Canopy Handles
- Shower Head, Arm & Flange
- 1/2" I.P.S. or 1/2" nominal copper Union Inlets
- Ceramic Disc Cartridges
- 8" Centers
- 1/2" IPS Brass Tub Spout

FINISHES

- PC Polished Chrome

STANDARDS

- ASME A112.18.1



WARRANTY

- Lifetime Limited Warranty
- Lifetime Residential Warranty
- 5 Year Commercial Warranty

80968/REV. 11 2016

Product Specifications subject to change without notice

Job Name _____ Date _____

Model Specified _____ QTY _____

Customer/Wholesaler _____

Contractor _____

Architect/Engineer _____

Submitted as Shown _____

Submitted w/ Variations _____

Model# 80968

Three Handle Tub & Shower Set

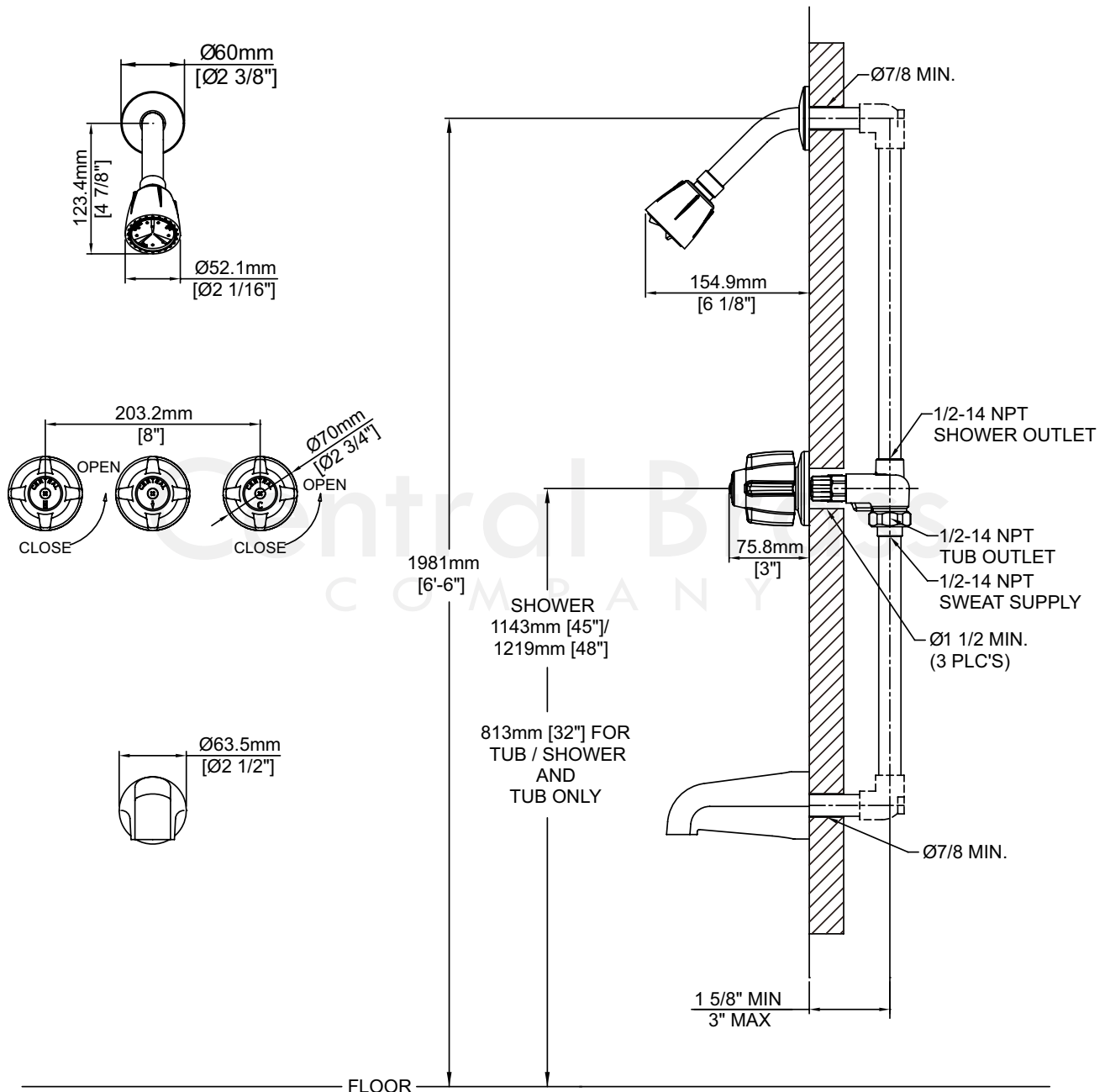

80968/REV. 11 2016

Product Specifications subject to change without notice