

NEED HELP?
Call or Email us first

Our service team is ready to answer your questions...
1-800-265-1833 (English) / 1-800-567-2513 (French)
IN CANADA - ressaescanada@canarmna.ca - IN USA - ressaesusa@canarmna.ca

Monday – Friday
8 AM - 5 PM EST.



INSTRUCTIONS PERTAINING TO RISK OF FIRE OR INJURY TO PERSONS
READ ALL INSTRUCTIONS

IMPORTANT SAFETY INSTRUCTIONS
SAVE THESE INSTRUCTIONS

TOOLS AND MATERIALS REQUIRED:



Phillips
Screwdriver



Wire Cutters



Pliers



Wrench

Wiring supplies
as required by
local electrical
code

SAFETY PRECAUTIONS:

1. TURN OFF ELECTRICAL POWER BEFORE STARTING INSTALLATION OF LIGHT FIXTURE.
2. THIS PRODUCT MUST BE INSTALLED IN ACCORDANCE WITH THE APPLICABLE INSTALLATION CODE BY A PERSON FAMILIAR WITH THE CONSTRUCTION AND OPERATION OF THE PRODUCT AND THE HAZARDS INVOLVED.
3. CONNECT THE GROUND WIRES (BARE COPPER OR GREEN) FROM YOUR FIXTURE TO THE GROUND WIRE (BARE COPPER OR GREEN) OR GROUND SCREW IN THE ELECTRICAL BOX.
4. TO CLEAN THE FIXTURE, TURN OFF THE POWER, WAIT FOR IT TO COOL, AND WIPE THE FIXTURE WITH A CLEAN, SOFT CLOTH.

NOTE: Product may not look exactly as shown in figures.

INSTALLATION:

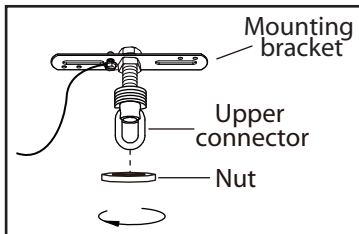

1. Determine the height that you would like to hang your fixture. Trim the cord and chain. Allow 10" of extra wiring for the electrical box connections. Remove the nut from upper connector.

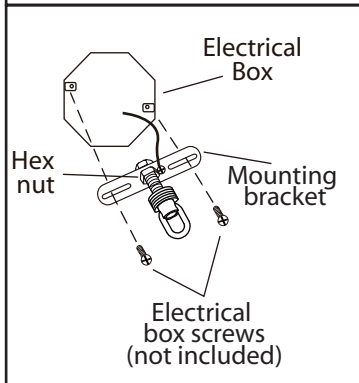

2. Attach the mounting bracket to the electrical box using electrical box screws (not included). Attach the nipple to the mounting bracket and adjust until it will clear the canopy when assembled (Place the canopy over the nipple and tighten the upper connector onto the nipple until snug. The upper connector should hold the canopy snug to the ceiling). Lock the nipple in the correct position using the hex nut.

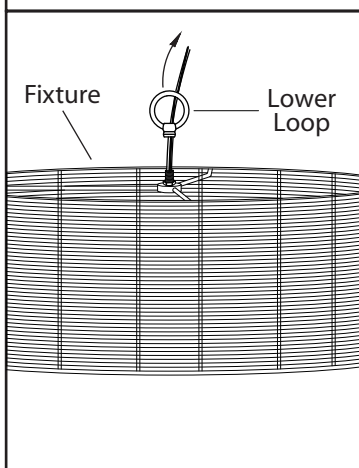

3. Tighten the lower loop to the stem on the fixture.

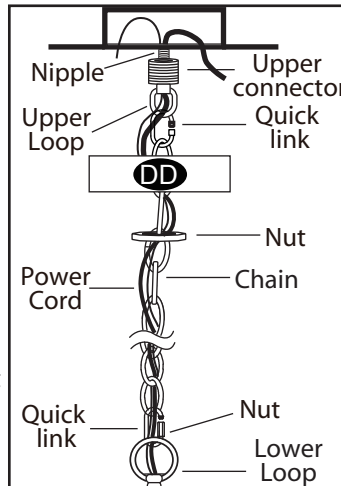

4. Weave the power cord and fixture ground wire through the chain, the nut and the canopy.

5. Connect the chain to the lower loop and the upper loop on the upper connector using the two quick link. **Seal the opening on the quick link by screwing the nut.**

6. Thread the power cord and fixture ground wire through the center of the upper connector. Tighten the upper connector onto the nipple.

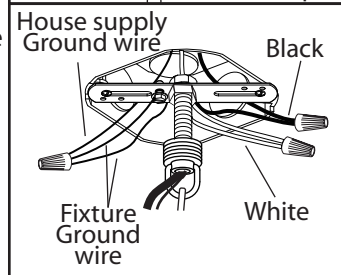

7. Connect the ground wires (bare copper or green) from your fixture to the ground wire (bare copper or green) or ground screw in the electrical box. Connect the black wire (or wire marked "SPT-1") from the fixture to the black wire in the electrical box and connect the white wire (or the wire with ribbed side) from the fixture to the white wire in the electrical box.

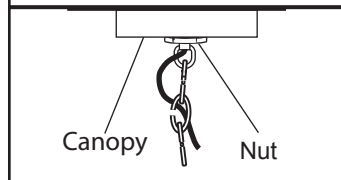

8. Once connections of wires are completed, carefully tuck wires and wire nuts into the electrical box making sure no bare wire (on the black and white) is visible at the wire nuts.

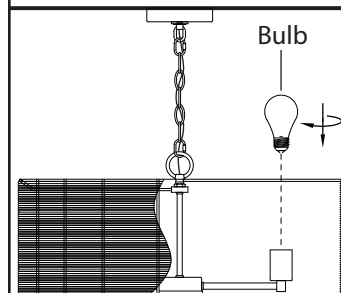

9. Slide the canopy up the chain and over the upper connector. Slide the nut up the chain and thread onto the upper connector.

10. Install specified bulb type and wattage (not included).