

California Faucets reserves the right to make modification and specification changes at any time. Please visit www.calfaucets.com for most current technical data.

CALIFORNIA FAUCETS RECOMMENDS THAT ALL PLUMBING PRODUCTS BE INSTALLED BY A LICENSED PROFESSIONAL

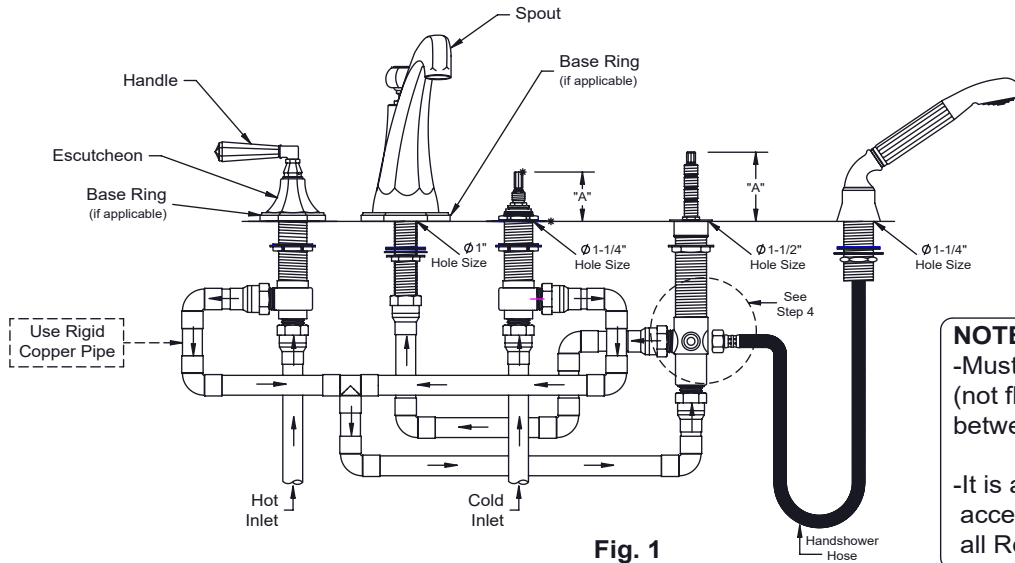

NOTE:
 -Must use rigid copper piping (not flex) for all connections between spout and valves.
 -It is also recommended that an access panel be provided for all Roman Tub installations.

1

Roman Tub Spout Connectors

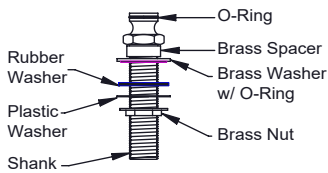

Fig. 2A

Fig. 2B



Fig. 2C



Fig. 2D

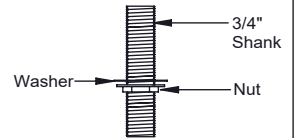

Fig. 2E

Quick Connect Model #: QC-50 Use With Rough Kit #: 08-75-50	Quick Connect Model #: QC-99 Use With Rough Kit #: 08-75-99	Quick Connect Model #: QC-63 Use With Rough Kit #: 08-75-63	Quick Connect Model #: QC-63 Use With Rough Kit #: 08-75-65	3/4" Nipple Model #: QC-75 Use With Rough Kit #: 08-75-75
For Series #: 5008	For Series #: 3208 3308 3408 3508 3608 3808 4008 4208 4408 4508 4508X 4608 4708 5108 5508 5808 5908 6008 6108 6408 6708 6808 6908	For Series #: 6308 <i>Series 6308 uses Broach Adapter</i>	For Series #: 3008 3008K 3008F 3008X 3008XK 3008XF 3108 3108K 3108F 3108X 3108XK 3108XF 4808 4808X 6508 6608	For Series #: 5208 5208F 5208K 5308 5308F 5308K 7008 7208 7308

For all Quick Connect except: 08-75-75

- Remove brass nut, plastic washer and rubber washer from Quick Connect assembly.
- Ensure that O-ring is properly seated in brass washer.
- Insert Quick Connect assembly through hole in deck.
- Place Rubber Washer, Plastic Washer and Brass Nut onto Shank from below and firmly tighten.
- Seat Spout onto Quick Connect.
- Rotate Spout to desired position and tighten setscrew.
- Use thread sealant to seal all fittings with threads.

For Quick Connect: 08-75-75

- Apply thread sealant to one end of the Shank and tighten into Spout.
- Place spout base ring (if applicable) onto deck, over the spout shank.
- Insert Shank through deck hole and from below place Washer and Nut onto Shank.
- Rotate Spout to desired position and firmly tighten nut.
- Use thread sealant to seal all fittings with threads.

IMPORTANT: All soldering shall be performed prior to attaching fitting to Valves and Quick Connect, otherwise severe damage may take place and void warranty

2 Install valve bodies:

NOTE: Hot & cold valves are labeled: *cold=blue & hot=red.*

-Remove top nut and turn bottom nut with fiber washer down the valve until it stops.

-Insert valve through hole from below and install top nut (if applicable), and adjust to proper height, see Fig. 4A (also refer to "A" dimension).

-Tighten the bottom nut to secure the valve.

-Install trim parts (base ring if applicable), escutcheon and handle and tighten handle set screws with Allen key provided.

REMINDER: Please retain allen key as handles may require re-tightening with normal use.

Installation Note for series:

32, 33, 34, 35, 36, 43, 57, 60, 61, 67, 68 & 69.

The trim to those products do not require a top nut to be installed on the valve (See Fig. 4A)

The decorative base ring and escutcheon takes the place of the top nut. (See Fig. 4B).

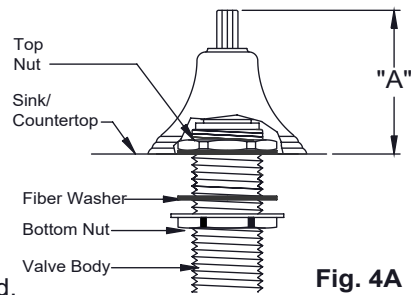

Fig. 4A

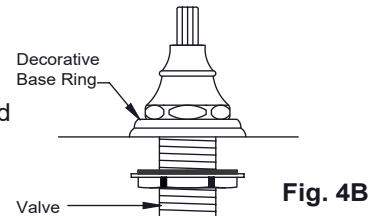

Fig. 4B

"A"

DIMENSION

"A" Dimension is from top of counter/tub top to tip of stem broach.

Series #	Handle	Diverter
3008	1 3/4"	1 3/4"
3108	1 3/4"	1 3/4"
3208	2 3/8"	2 3/8"
3308	2 3/8"	2 3/8"
3408	2 3/8"	2 3/8"
3508	2 3/8"	2 3/8"
3608	2 3/8"	2 3/8"
3808	2 5/8"	2 5/8"
4008	2 5/8"	2 5/8"
4208	2 5/8"	2 5/8"
4408	2 3/8"	2 3/8"
4508.X	2"	2"
4608	2 1/2"	2 1/2"
4708	2 1/2"	2 1/2"
4808.X	2 5/16"	2 5/16"
5108	2 1/2"	2 1/2"
5208	1 3/8"	1 3/8"
5308	1 3/8"	1 3/8"
5508	2 5/8"	2 5/8"
5708	2"	2"
5808	2 5/8"	2 5/8"
5908	2 5/8"	2 5/8"
6008	2 1/4"	2 1/4"
6108	2 1/4"	2 1/4"
6208	1 1/8"	1 1/8"
6308	3"	3"
6408	2 5/8"	2 5/8"
6508	2"	2"
6608	2"	2"
6708	2 1/4"	2 1/4"
6808	2 3/8"	2 3/8"
6908	2 3/8"	2 3/8"
7008	1 3/8"	1 3/8"
7108	1"	1"
7208	1"	1"
7308	1"	1"
7408	3/4"	3/4"
7708	1 5/16"	1 5/16"
7708R	1"	1"
E308	15/16"	15/16"
E408	15/16"	15/16"

3 Install deck holder and handshower:

-Remove threaded nipple from spray holder. Insert threaded nipple up through deck, keeping lock nut, steel washer and rubber washer facing up towards deck from below. (See fig. 5)

-Reattach spray holder to threaded nipple and lock down from below.

-Insert handshower hose with hex nut end first.

-Ensure rubber washer is in the conical nut of the handshower hose and thread into the handshower elbow.

-Place fiber washer between handshower and the handshower elbow and thread together.

-Ensure rubber washer is in hex nut of handshower hose and connect to 1/2" out port of the diverter valve.

-Install piping (not supplied) to connect valve, spout and diverter (See Fig. 1 for piping diagram. See Fig. 6A for inlet/outlet configuration of diverter).

NOTE: The manufacturer recommends these connections be made in hard copper.

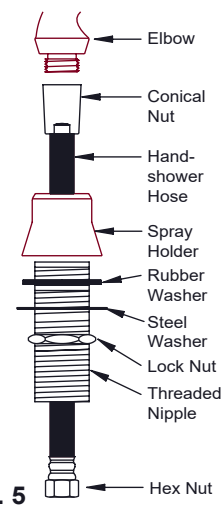

Fig. 5

4 Deck Diverter Installation

-Remove All-thread, Broach, Trim Nut and Hub from Body.

-Hole diameter size in deck or tub needs to be 1-1/2"

-Insert Body through the hole from underside and reinstall the Hub (hand tight only) until it stops against the O-Ring on Body.

-Align the Body into the desired position to allow easy connection access to ports, pull Body down and tighten the Bottom Nut securely.

Connection types: NPT Thread (or) copper sweat "solder"

-For solder connections either directly to the valve, or within 6" of the valve, the **CARTRIDGE MUST BE REMOVED** from the body. When soldering do not apply excessive heat directly to the body. **WARNING: Failure to follow these directions can cause damage to the body and/or cartridge, and will nullify the warranty.**

-Fit the Broach to the Cartridge and rotate counter-clockwise until it stops.

-Use a permanent marker to locate the Stop Pin on the Hub (See Fig. 6B).

-Remove Broach and Cartridge with stop ring from the Body.

-Connect the mixed water from valves to the bottom 3/4" inlet.

-Connect the 3/4" outlet on side to the tub spout.

-Connect 1/2" outlet on side to the hand shower hose.

-After Body has cooled, reinstall the Cartridge carefully and align Stop Pin with the mark on the Hub (See Fig. 6B). Use Broach if necessary to rotate the Cartridge for alignment.

-Install the Stop Ring in top of Body (fit one way) and push down into notches.

-Install Trim Nut, Broach and All-thread (do not overtighten All-thread).

NOTE: Prior to trim installation, it may be necessary to cut Broach and All-thread to dimension "A", All-thread shall be cut 1/2" less than Broach.

-Install trim (base ring if applicable), escutcheon, handle and tighten setscrews.

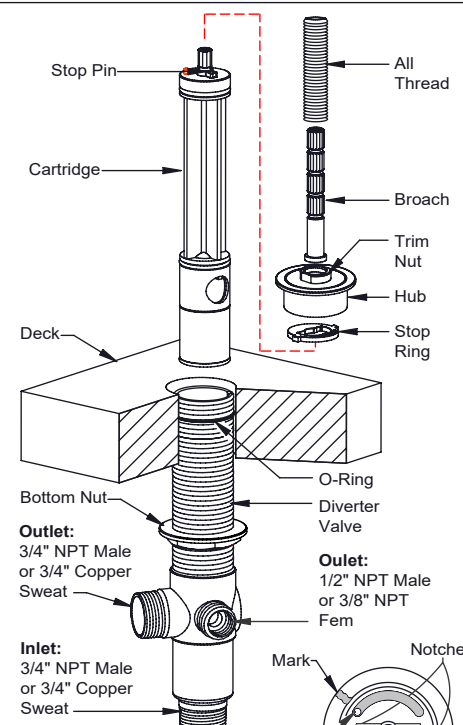

Fig. 6A

Fig. 6B