



Suggested Uses

- Shower drain
- Patio/Atrium drains
- Other wetted area floor drains

Features

- Over 30 finishes including 14 PVD finishes
- Solid brass decorative grid with no visible surface screws
- Surface is foot friendly with no sharp edges
- Rigid grid construction - will not dish or bend
- Square design for easy floor design and installation
- Outlet flow rate: 19 gpm (73 Lpm) with 1/4" head of water
- Latex coated cast iron body with reversible weep-hole membrane collar
- Outlet connection: 3" no-hub

Codes/Standards Applicable

- Specified model meets or exceeds the following:
- ASME A112.18.2/CSA B125.2
- US PAT NO. 8043497

9172-3

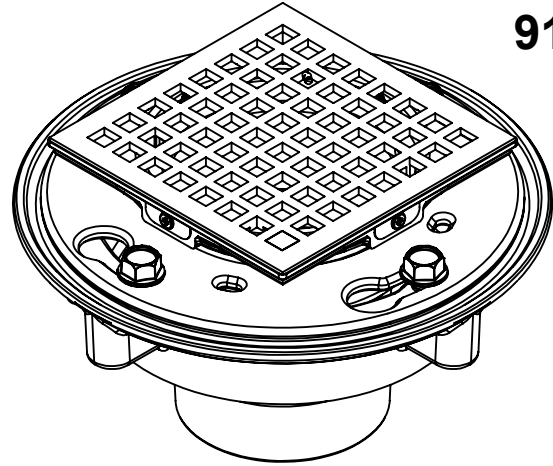

CAST IRON 3" NO HUB

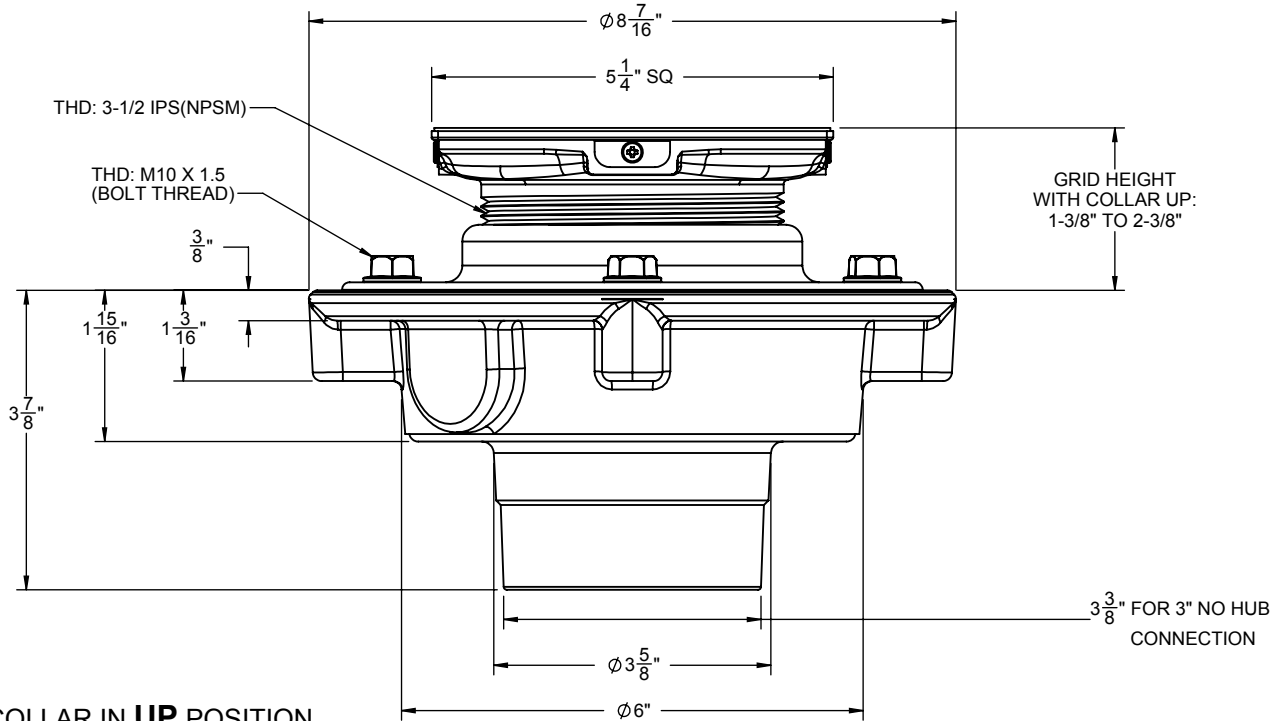

Figure 1. COLLAR IN UP POSITION

Figure 2. COLLAR IN DOWN POSITION

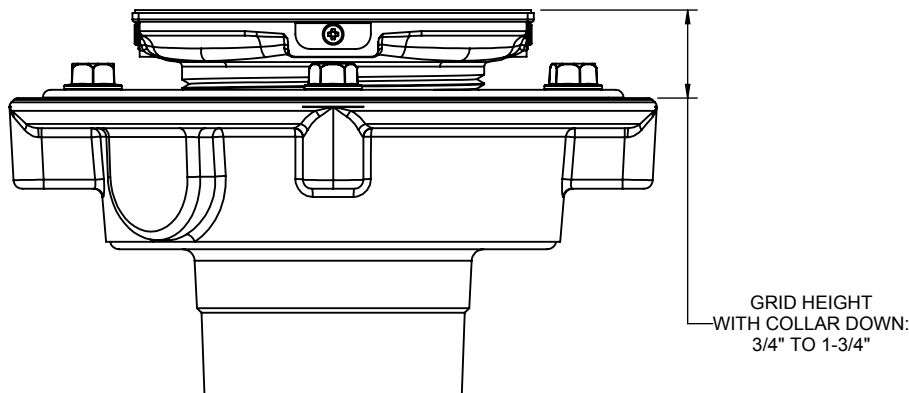
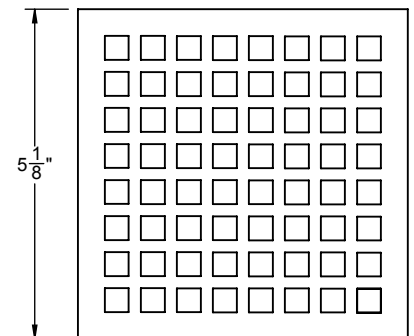

Figure 3. MISSION PATTERN



OPEN AREA = 8.95 in²

ALL DIMENSIONS SHOWN TO NEAREST 1/16"