



# CAL LIGHTING

3625 E. Philadelphia St. Ontario CA. 91761. Tel: 909.947.5200. Fax:  
909.947.5673. www.calighting.com. service@calighting.com.  
Specifications subject to change without notice

Type: \_\_\_\_\_

Project: \_\_\_\_\_

Catalog No.: \_\_\_\_\_

BO-3117AC

Lamp/Wattage: \_\_\_\_\_

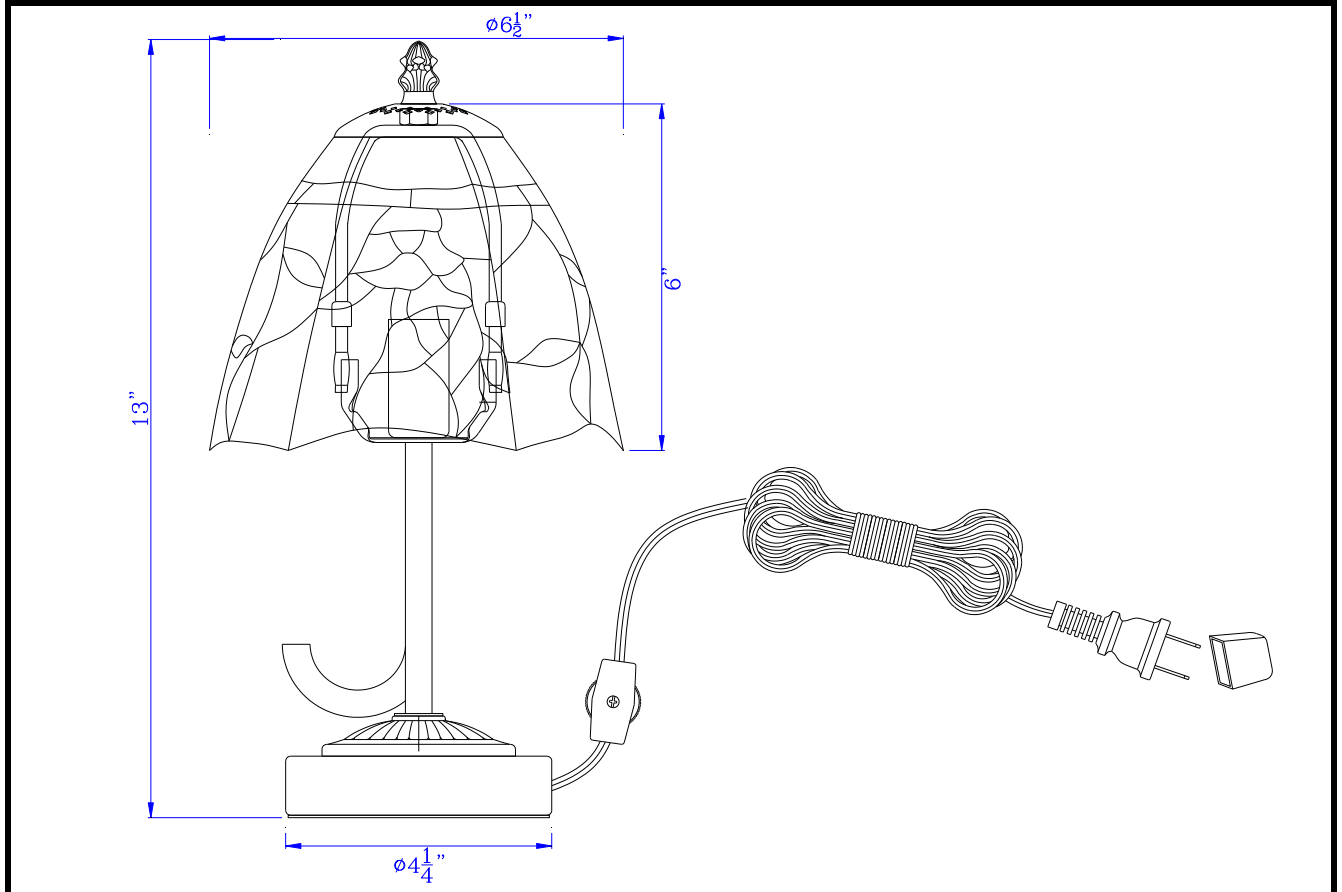

- Model No:** BO-3117AC  
**Description:** 40W metal/resin Tiffany accent lamp with inline switch  
**Material:** Metal  
**Finish :** Dark Bronze  
**Height:** 13"  
**Base Width:** Dia.4 1/4"  
**Wattage :** 40W  
**Socket :** Candelabra Base (E12)  
**Switch:** ON/Off In-line  
**Bulb:** Incandescent  
**Wire Length:** 6'  
**Wire Color:** Brown  
**Shade No:**  
**Material:** Tiffany  
**Shade size:** Dia.6 1/2" H 6"

**Certificate :** 