

Café™ 20.2 Cu. Ft. Fully Integrated Multi-Door Bottom Freezer

CIC36LP2VS1, CIC36RP2VS1

CAFÉ

DISTINCT BY DESIGN™



CIC36LP2VS1
Stainless Steel with Brushed
Stainless handles



WARRANTY

Labor Warranty	Limited 1-year entire appliance Limited 5-year sealed refrigerating system
Parts Warranty	Limited 1-year entire appliance Limited 5-year sealed refrigerating system

FEATURES & BENEFITS

Exterior style	Built-In Standard Installation 3-Door Bottom Freezer
Total Capacity	20.2 Cu. Ft.
FF Capacity	13.8 Cu. Ft.
FZ Capacity	3.5 Cu. Ft.
Convertible Drawer	2.9 Cu. Ft.
ADA Compliant	No
Energy Star	No
Depth	Built-In
Ice & Water Dispenser	No
Icemaker	Yes
Water Filtration	Yes
Control Type	Upfront Electronic Digital Temperature Display
Internal Lighting	LED
Colors Available	Stainless Steel
Case Color	Unfinished Sides or Panel Required
Claims & Certifications	MADE IN AMERICA, California Prop 65
Configuration	Full door
Temperature Management Features	Integrated Air Management System
Cabinet shelves (total ff & fz)	4 Half Width; 1 Full Width
Door bins (total ff & fz)	3 Full Width Adjustable
Fresh food cabinet shelf features	4 Adjustable glass; 1 fixed
Glass shelves	Yes
Fresh food cabinet pans/drawers	2
Clear bins and pans	Yes
Fresh Food Drawer Features	Adjustable humidity
Fresh food door bins	3
Fresh food door bins type	3 full width adjustable
Freezer Drawer	Equipped with ice maker and divider slide
Convertible Drawer	4 Temperature Settings: cold drinks, meat, snacks or frozen items
Filter change indicator	Yes - on upfront control
GE water filtration system	XWFE Leak Detect in top above case
Leveling system	4 Point (2 adjustable back rollers, 2 adjustable front legs)
Refrigerant type	r600a
Sealed system design	Yes
Defrost type	Automatic defrost
Connected	ConnectPlus WiFi; App details; Display/change temperature; Alert if fresh food temperature is too high; Alert if freezer temperature is too high; Alert if water filter needs to be replaced; Alert for software OTA updates

WEIGHTS & DIMENSIONS

Overall depth	24-3/4 in.
Overall width	35-3/4 in.
Overall height	83-7/8 in.
Case depth without door	22-1/8 in.
Depth without handle	24-3/4 in.
Height to top of case	83-11/16 in.
Approximate shipping weight	590 lbs.
Net weight	550 lbs.

ADDITIONAL ACCESSORIES



CXSB3H3PVBZ
Brushed Bronze
Optional Kits



CXSB3H3PVBT
Brushed Black
Optional Kits



CXSB3H3PVCU
Brushed Copper
Optional Kits



CXSB3H3PVCG
Brushed Brass
Optional Kits



CXSB3H3PVFB
Flat Black
Optional Kits

Café™ 20.2 Cu. Ft. Fully Integrated Multi-Door Bottom Freezer

CIC36LP2VS1, CIC36RP2VS1

CAFÉ

DISTINCT BY DESIGN™

DIMENSIONS AND INSTALLATION

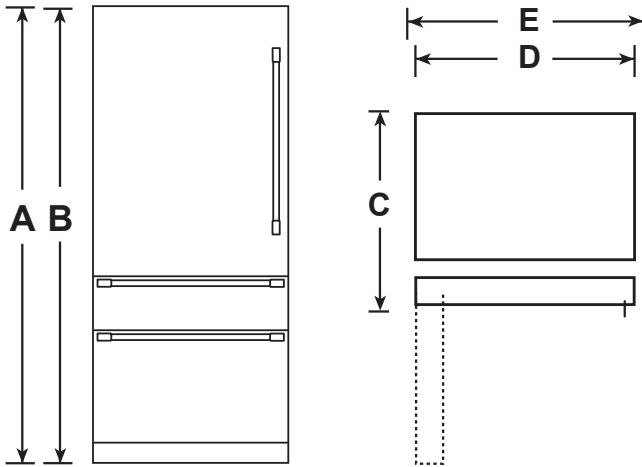

Overall Weights & Dimensions	A - Overall Height	83 7/8
	B - Height to Top of Case (in)	83 11/16
	C - Unit Depth With Door Closed With handle (in)	27 5/16
	D - Case Width (in)	35 5/16
	E - Overall Width (in)	35 3/4
	Approximate Shipping Weight (lb)	590
	Net Weight (lb)	550

Power / Ratings	
Volts/Hertz/Amps 115V 60Hz 20A	

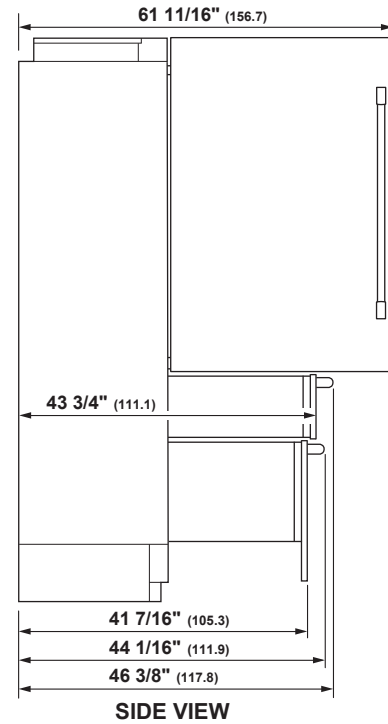

SIDE VIEW

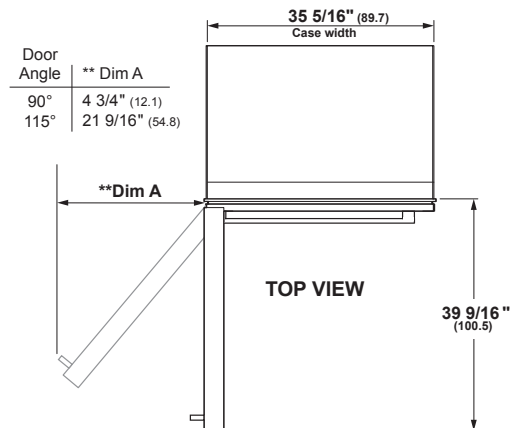

TOP VIEW

**PRODUCT CLEARANCES

The factory set 115° door swing can be adjusted to 90° if clearance to adjacent cabinets or walls is restricted.

GROUNDING THE REFRIGERATOR

IMPORTANT—PLEASE READ CAREFULLY

FOR PERSONAL SAFETY, THIS APPLIANCE MUST BE PROPERLY GROUNDING.

The power supply cord of this appliance is equipped with a three-prong (grounding) plug which mates with a standard three-prong (grounding) wall receptacle to minimize the possibility of electric shock hazard from this appliance.

Have the wall outlet and circuit checked by a qualified electrician to make sure the outlet is properly grounded.

Where a standard 2-prong wall outlet is encountered, it is your personal responsibility and obligation to have it replaced with a properly grounded 3-prong wall outlet.

DO NOT UNDER ANY CIRCUMSTANCES, CUT OR REMOVE THE THIRD (GROUND) PRONG FROM THE POWER CORD.

DO NOT USE AN ADAPTER PLUG TO CONNECT THE REFRIGERATOR TO A 2-PRONG OUTLET.

DO NOT USE AN EXTENSION CORD WITH THIS APPLIANCE.

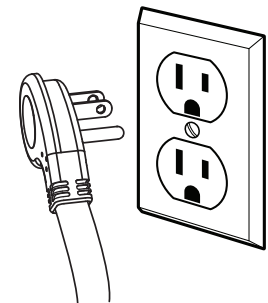

Café™ 20.2 Cu. Ft. Fully Integrated Installation Multi-Door Bottom Freezer

CAFÉ

DISTINCT BY DESIGN™

CIC36LP2VS1, CIC36RP2VS1

DIMENSIONS AND INSTALLATION (FULLY INTEGRATED INSTALLATION)

FLOORING

For proper installation, this refrigerator must be placed on a level surface of hard material that is at the same height as the rest of the flooring. This surface should be strong enough to support a fully loaded refrigerator, or approximately 1500 lbs.

NOTE: Protect the finish of the flooring. Cut a large section of the cardboard carton and place under the refrigerator where you are working.

WATER AND ELECTRICAL LOCATIONS

The opening must be prepared with the electrical and water supply located as shown.

FINISHED RETURN OF 6" REQUIRED

A minimum 6" (15.2) finished return matching cabinet exterior recommended on interior on all sides and top at front of opening.

ADDITIONAL SPECIFICATIONS

A 120 volt, 60Hz, 15 or 20 amp power supply is required. An individual properly grounded branch circuit or circuit breaker is recommended. Install a properly grounded 3-prong electrical receptacle recessed into the back wall. Electrical must be located on rear wall as shown.

SINGLE INSTALLATION

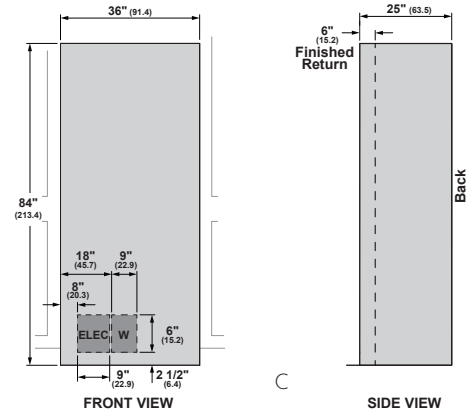

DUAL INSTALLATION

36" INTEGRATED BOTTOM FREEZER (LEFT-HAND SWING), CIC36LP2VS1 36" INTEGRATED BOTTOM FREEZER (RIGHT-HAND SWING), CIC36RP2VS1

A separate 115V, 60Hz, 15- or 20-amp power supply is recommended for each product. Cutout based on installation of two products with a left-and-right-hand door swing.

A minimum 6" (15.2) finished return matching cabinet exterior recommended on interior on all sides and top at front of opening.

ZKMV Unification Kit is required for Side-by-Side Heater/Dual Installation. Kit generates the 15/16" between units and overall cut out width includes this dimension.

DUAL INSTALLATION ACCESSORY KITS

ZKN72V: 72" stainless full-width toe kick

ZKMV: Integrated bottom-freezer unification/heater kit

DUAL PRODUCT CLEARANCES

In a side-by-side installation of a left-and-right-hand door swing product, 15/16" clearance between the units is required. Also required is Side-by-Side Heater/ Dual Installation Kit, ZKMV.

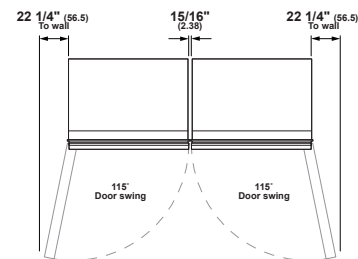
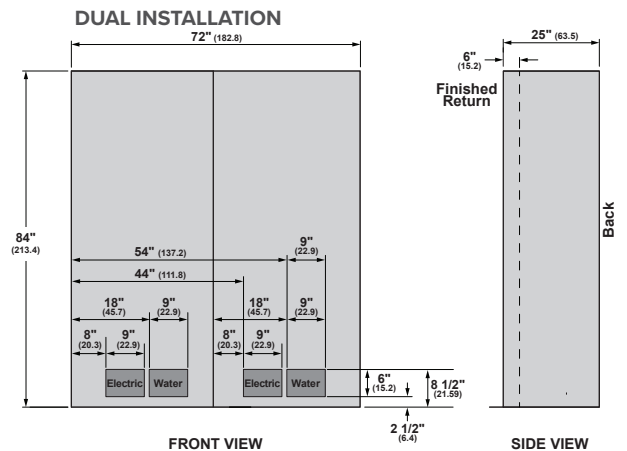

** Dimensions based on handle height of 2 9/16" (6.5)

NOTE: GFI (ground fault interrupter) is not recommended. Water line can enter the opening through the floor or rear wall. The water line installed should be 1/4" O.D. copper tubing or GE SmartConnect™ tubing between the cold water line and water connection location. The line should be long enough to extend to the front of the refrigerator. Installation of an easily accessible shutoff valve in the water line is required.

Café™ 20.2 Cu. Ft. Standard Installation Multi-Door Bottom Freezer



DISTINCT BY DESIGN™

CIC36LP2VS1, CIC36RP2VS1

DIMENSIONS AND INSTALLATION (STANDARD INSTALLATION)

FLOORING

For proper installation, this refrigerator must be placed on a level surface of hard material that is at the same height as the rest of the flooring. This surface should be strong enough to support a fully loaded refrigerator, or approximately 1500 lbs.

NOTE: Protect the finish of the flooring. Cut a large section of the cardboard carton and place under the refrigerator where you are working.

WATER AND ELECTRICAL LOCATIONS

The opening must be prepared with the electrical and water supply located as shown.

ADDITIONAL SPECIFICATIONS

A 120 volt, 60Hz, 15 or 20 amp power supply is required. An individual properly grounded branch circuit or circuit breaker is recommended. Install a properly grounded 3-prong electrical receptacle recessed into the back wall. Electrical must be located on rear wall as shown.

SINGLE INSTALLATION ACCESSORY KIT*

ZKW36V - Standard Installation Kit (required when installing in a 35 1/2" wide and 24" deep cut-out.)

*Product at Standard trim is 36 13/16" (93.5 cm) wide, 28 3/8" (72.1 cm) deep, and 84 1/2" (214.6 cm) height.

SINGLE INSTALLATION

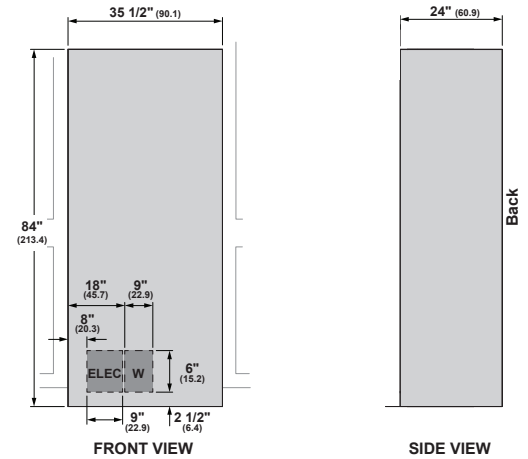

DUAL INSTALLATION**

36" INTEGRATED BOTTOM FREEZER (LEFT-HAND SWING), CIC36LP2VS1

36" INTEGRATED BOTTOM FREEZER (RIGHT-HAND SWING), CIC36RP2VS1

A separate 115V, 60Hz, 15- or 20-amp power supply is recommended for each product. Cutout based on installation of two products with a left-and-right-hand door swing.

ZKMV Unification Kit is required for Side-by-Side Heater/Dual Installation. Kit generates the 15/16" between units and overall cut out width includes this dimension.

DUAL INSTALLATION ACCESSORY KITS

ZKW72V: Standard dual-install kit (required when installing in a 71 1/2" wide and 24" deep cut-out.)

ZKK72R: 71-1/2" stainless full-width toekick

ZKMV: Integrated bottom-freezer unification/heater kit

DUAL PRODUCT CLEARANCES

In a side-by-side installation of a left-and-right-hand door swing product, 15/16" clearance between the units is required. Also required is Side-by-Side Heater/Dual Installation Kit, ZKMV.

**Product at Standard dual-install trim is 72 11/16" (184.7 cm) wide, 28 3/8" (72.1 cm) deep, and 84 1/2" (214.6 cm) height.

DUAL INSTALLATION

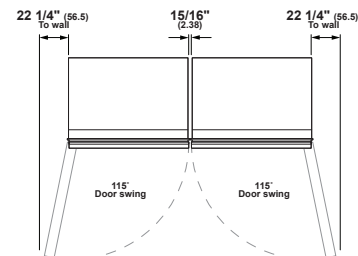
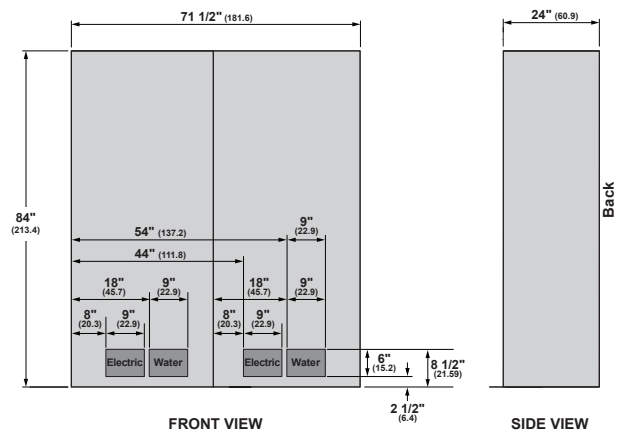

** Dimensions based on handle height of 2 9/16" (6.5)

NOTE: GFI (ground fault interrupter) is not recommended. Water line can enter the opening through the floor or rear wall. The water line installed should be 1/4" O.D. copper tubing or GE SmartConnect™ tubing between the cold water line and water connection location. The line should be long enough to extend to the front of the refrigerator. Installation of an easily accessible shutoff valve in the water line is required.