

MODEL XB110L1 VENTILATION FAN WITH LIGHT

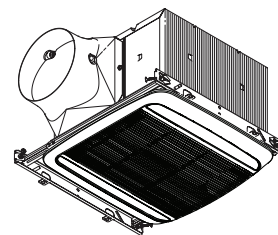

FEATURES

ULTRASMART™ DC Motor and Control Technology

- DC motor for efficiency well beyond ENERGY STAR® requirements.
- Can be used to comply with ASHRAE 62.2, LEED, ENERGY STAR® for Homes and CA Title 24.
- Powerful operation maintained over a wide range of real-world installations (CFM ratings maintained through at least 0.25" static pressure).
- Rated for Continuous Operation.

ULTRASILENT™ Sound Technology

- HVI certified, best-achievable <0.3 Sone level provides nearly silent operation for a relaxing environment.
- State-of-the-art blower and duct outlet design smooths airflow.
- High tech DC motor designed for nearly silent operation.

ULTRALUCENT™ Lighting Technology

LIGHTING / GRILLE:

- Highly efficient, 18 Watt, integrated LED, dimmable
- LED lasts up to 25,000 hours
- Unique, low profile design for wide light pattern
- Even lens diffusion eliminates hotspots

TO OPERATE FAN AND LIGHT:

- Use only an ON/OFF or timer switch to operate the fan.
- Use only an ON/OFF switch, timer switch or relay-switch to operate the LED light.
- The LED light can be used with some dimmable switches (see below).
- Both the fan and LED light can be put on one switch.

DIMMING CONTROLS :

- May not be compatible with all dimmer controls
- Each application is unique and various factors such as load, common neutrals or other electrical products on the circuit can, in certain instances, cause variance in system performance.
- Dimmer model numbers vary slightly depending on color, packaging type, etc. such that variations of Model numbers may be suitable. Consult dimming system manufacturer for additional support in operation

* For a list of compatible controls, see broan.com.

ULTRAQUICK™ Installation Technology

- Unique telescoping mounting frame fits through retrofit drywall opening to allow easy installation from the room side. No attic access needed!
- Captive screws allow for easy new construction installation.
- Mounting frame positioning tabs provide easy vertical positioning for new construction.
- Easy to insert and remove snap-in housing. No screws required!
- Easy to insert and remove snap-in blower.
- Inside or outside duct connector and knockout plate mounting provides flexibility for new construction or retrofit.

U.L. Listed for use over bathtubs and showers when connected to a GFCI protected branch circuit (ceiling mount only).

U.L. Listed for use in insulated ceilings (Type IC).

Use only ON/OFF switch, mechanical timer or relay-switched control.

3-year warranty.

DIMENSIONS (Inches)



JA8-2016

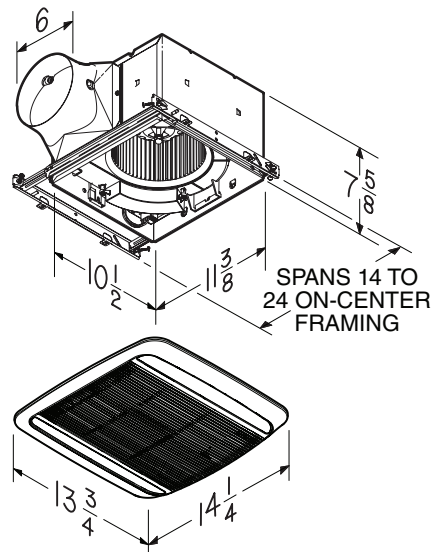

Broan Hartford, Wisconsin www.broan.com 800-558-1711

REFERENCE	QTY.	REMARKS	Project
			Location
			Architect
			Engineer
			Contractor
			Submitted by
			Date



PERFORMANCE SPECIFICATIONS

MODEL XB110L1 VENTILATION FAN WITH LIGHT

HVI PERFORMANCE

6" Duct				
0.1 Ps - Static Pressure (inH2O)				0.25 Ps
Airflow (CFM)	Sound (Sones)	Power (Watts)	Efficacy (CFM/Watt)	Airflow (CFM)
110	< 0.3	8.7	12.6	110



HVI-2100 CERTIFIED RATINGS comply with new testing technologies and procedures prescribed by the Home Ventilating Institute, for off-the-shelf products, as they are available to consumers. Product performance is rated at 0.1 in. static pressure, based on tests conducted in a state-of-the-art test laboratory. Sones are a measure of humanly-perceived loudness, based on laboratory measurements.

ELECTRICAL & WEIGHT

Volts	Hz	Amps*	Shipping Weight (lbs.)
120	60	0.5	13.7

* Total connected load

