

# BRIZO®

## ACCESSORIES

- Atavis™ Collection
- 18" Towel Bar

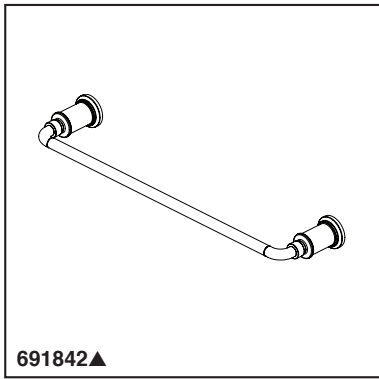

691842▲

Submitted Model No.: \_\_\_\_\_

Specific Features: \_\_\_\_\_

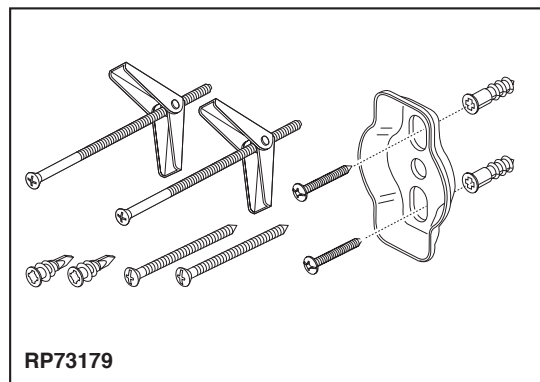
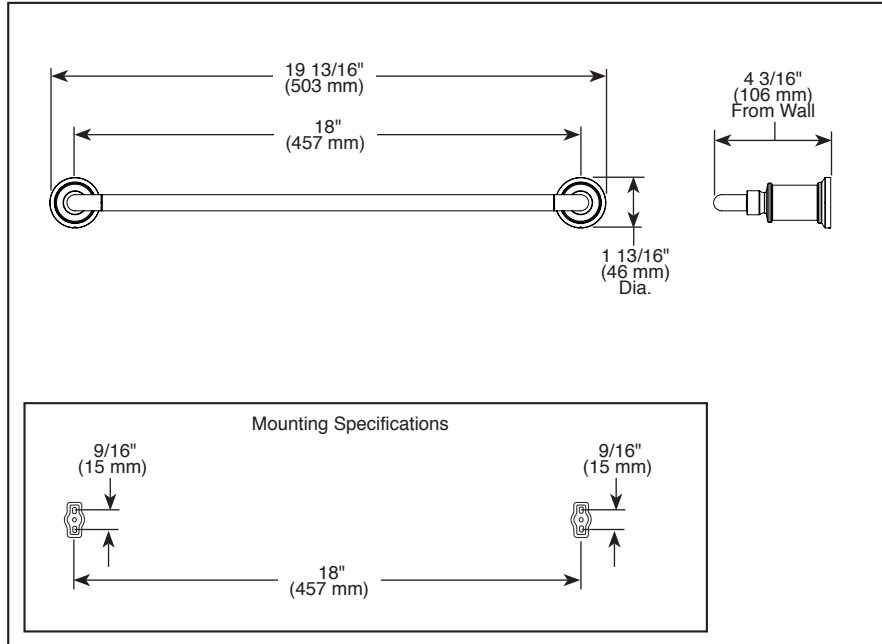

RP73179

▲ Designate proper finish suffix

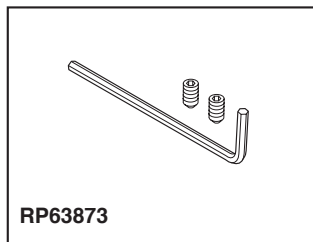

RP63873

### STANDARD SPECIFICATIONS:

- Wood blocking is preferable behind all wall surfaces. If wood blocking is not available, try finding a wood stud to anchor at least one end of this accessory.
- Mounting hardware and mounting instructions included with product.
- Note: Plastic anchors, screws, toggle bolts, and mounting brackets are included with the mounting hardware.

### WARRANTY

- Lifetime limited warranty on parts (other than electronic parts and batteries) and finishes; or, for commercial users, for 5 years from date of purchase.
- 5 year limited warranty on electronic parts (other than batteries); or, for commercial users, for 1 year from the date of purchase. No warranty is provided on batteries.