

**Models / Modelos / Modèles**

**65985LF**

**65985LF-ECO**

▲ Specify Finish  
Especifique el Acabado  
Précisez le Fini

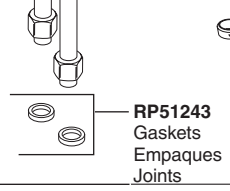
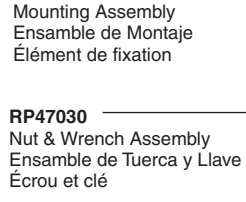
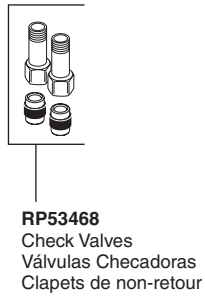
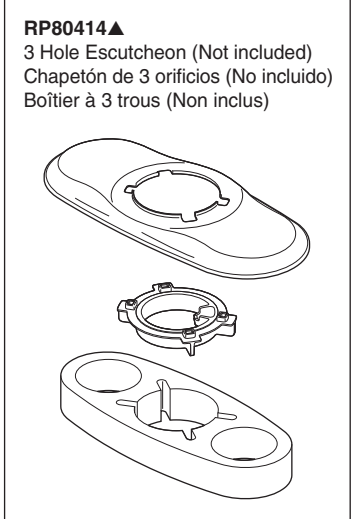
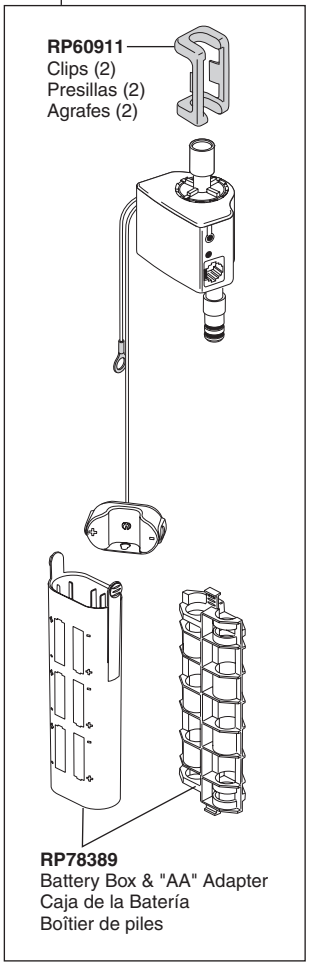
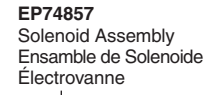
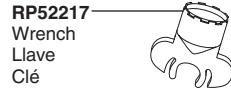
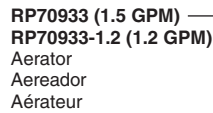
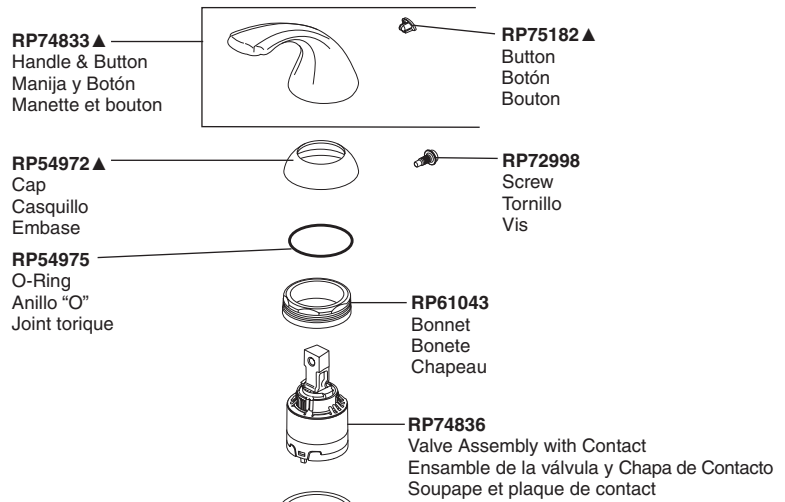

# Models / Modelos / Modèles

65985LF

65985LF-ECO

**Accessory Order Only**  
**Orden de Accesorio Solamente**  
**Livrablé séparément seulement**

**Drain is not included. Must order separately.**

**Drenaje no está incluido.  
Se debe ordenar por separado.**

**Le renvoi n'est pas inclus.  
À commander séparément**

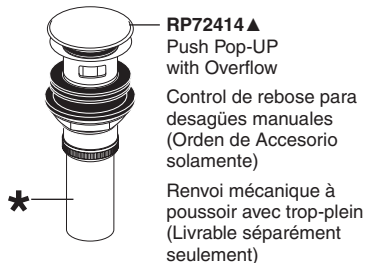
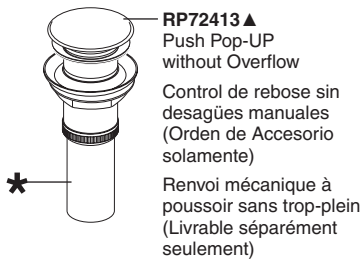
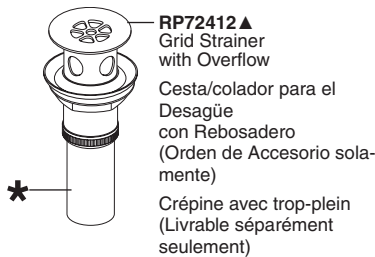
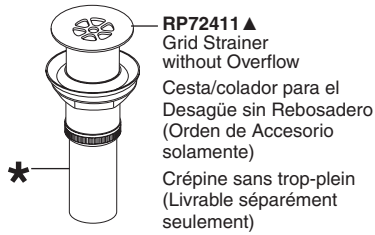

- \* **MUST use plastic tailpiece included with drain.**
- \* **DEBE utilizar tubos de plástico incluido con drenaje.**
- \* **DOIT utiliser un tuyau en plastique inclus avec le renvoi.**

**RP63263**  
Adapters  
3/8"-24 UNEF to 1/2"-20 UN &  
3/8"-24 UNEF to 1/2"-14 NPSM

Adaptadors  
3/8"-24 UNEF a 1/2" -20 UN &  
3/8"-24 UNEF a 1/2" -14 NPSM

Adapteurs  
3/8 po-24 UNEF à 1/2 po-20 UN et  
3/8 po-24 UNEF à 1/2 po-14 NPSM

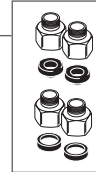

**RP63264**  
Adapters (10) 3/8" -24 UNEF to 1/2" -20 UN  
Adaptadors (10) 3/8" -24 UNEF a 1/2" -20 UN  
Adapteurs (10) 3/8 po-24 UNEF à 1/2 po-20 UN



**RP63265**  
Adapters (10) 3/8"-24 UNEF to 1/2"-14 NPSM  
Adaptadors (10) 3/8" -24 UNEF a 1/2" -14 NPSM  
Adapteurs (10) 3/8 po-24 UNEF à 1/2 po-14 NPSM

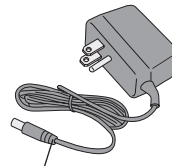

**EP73954**  
9v Power Supply  
(Accessory Order Only)

Fuente de alimentación de 9V (Este accesorio es disponible solo por orden)

Bloc d'alimentation 9 volts (livrablé séparément seulement)