

# Cabinet & Drawer Specifications

## Frame cabinet applications

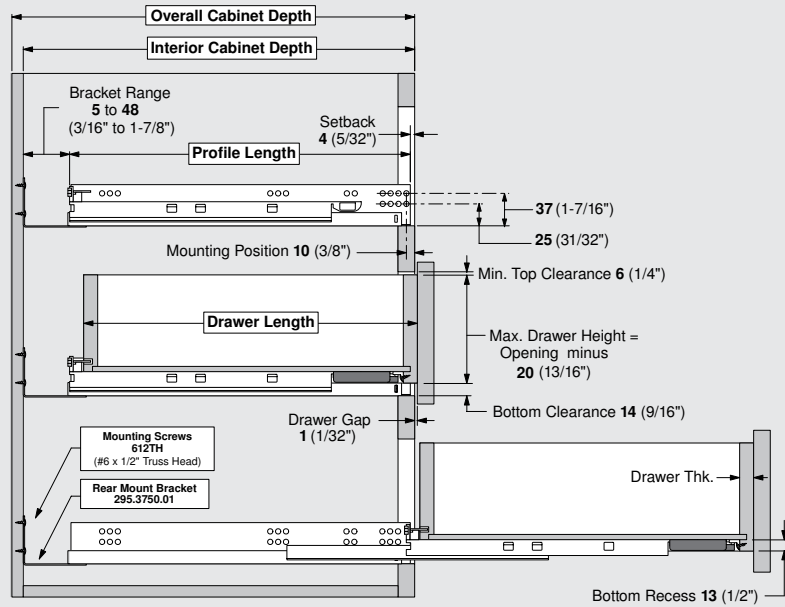

Runner	Overall Cabinet Depth	Interior Cabinet Depth		Drawer Length	Max. Drawer Thk.	Profile Length
		Maximum	Minimum			
562H5330B	610 (24")	598 (23-9/16")	555 (21-7/8")	533 (21")	16 (5/8")	546 (21-1/2")
562H4570B	533 (21")	522 (20-9/16")	479 (18-7/8")	457 (18")		470 (18-1/2")
562H3810B	457 (18")	446 (17-9/16")	403 (15-7/8")	381 (15")		394 (15-1/2")
562H3050B	381 (15")	369 (14-9/16")	326 (12-7/8")	305 (12")		317 (12-1/2")
562H2290B	305 (12")	266 (10-15/32")	299 (11-13/16")	229 (9")		257 (10-1/8")

- T51.1700.04R Locking device (right) 295.3750.01 Rear mounting bracket, non-handed
- T51.1700.04L Locking device (left) 295.3700.21 562H2290B Rear bracket, non-handed
- 295.3700.22 562H2290B Rear bracket, non-handed

- 612TH Installation screw (for locking devices and rear mounting brackets)
- 707N Installation screw (for mounting runner to cabinet side)

## Bottom mount application

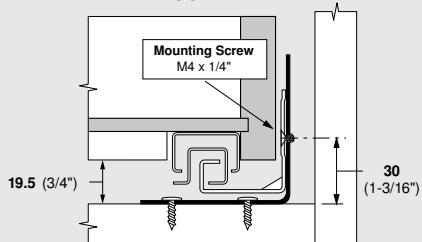

- 295.4000 Universal drawer bracket set
  - Includes (4) brackets
  - Includes (8) M4 screws
- 612TH Installation screw

All dimensions in millimeters. (Inch equivalents as noted)

Subject to technical modifications without notice. Copyright 2009

# Drawer Size & Mounting Positions

## For Frame and Panel cabinet applications

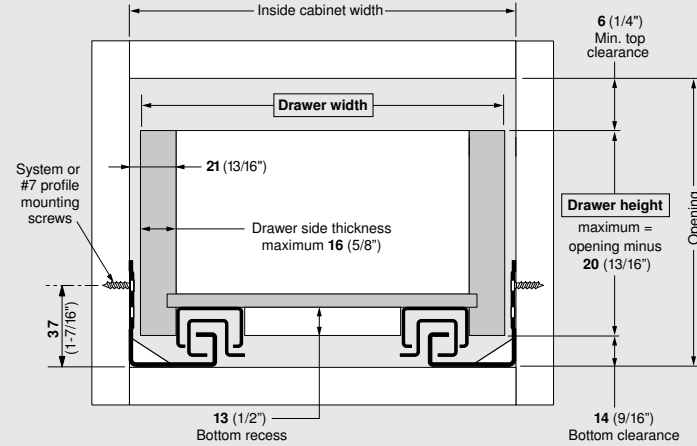

Formula for calculating outside drawer width					
For drawer side thickness	16 (5/8")	15 (19/32")	14 (9/16")	13 (1/2")	12 (15/32")
Deduct from inside cabinet width	10 (3/8")	12 (15/32")	14 (9/16")	16 (5/8")	18 (23/32")

**NOTE:** Because material thickness may vary, the inside drawer width must equal interior cabinet width minus 42 (1-5/8") for TANDEM to align and run properly.

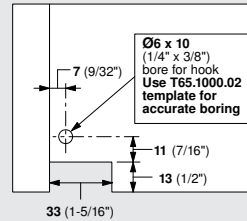

## Preparing drawer for hardware installation

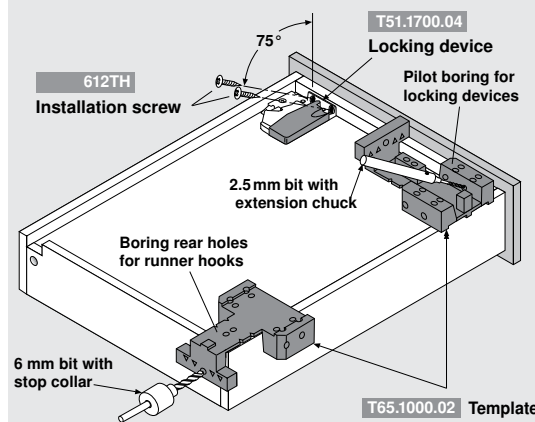

**Important:** Use of the T65.1000.02 template is recommended for accurate location and angle of locking device pilot holes.

## Rear bracket

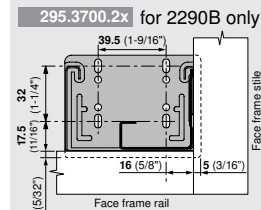
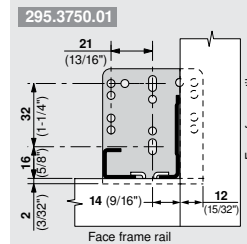

**NOTE:** For frame applications. Minimum 3 screws per bracket.

All dimensions in millimeters. (Inch equivalents as noted)

Subject to technical modifications without notice. Copyright 2009

# Installation Instructions

## TANDEM plus BLUMOTION 562H

### Full extension concealed drawer runners

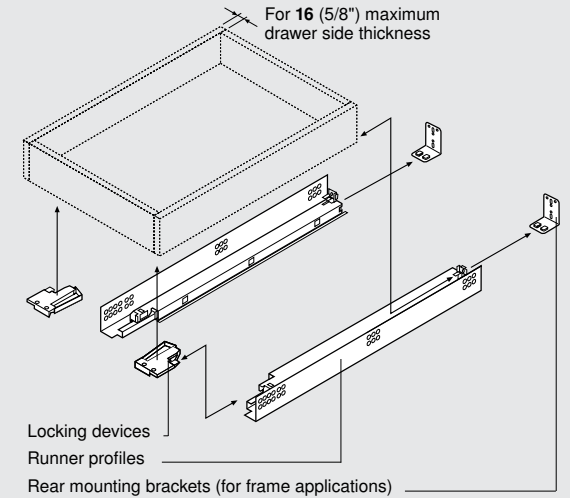

### Drawer removal and installation

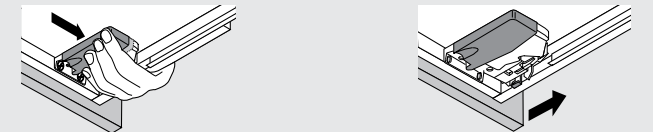

- Squeeze orange handles on locking devices
- Pull drawer straight out and up

- Place drawer on runners and close, locking devices will automatically connect to runners

### Height adjustment

- Press up on adjustment tab.
- Push towards back of drawer. Max. 3 (1/8") rise of drawer.

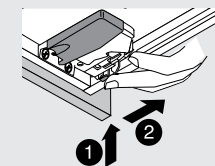

### Tilt adjustment

- Rotate the tilt adjustment lever on the rear of each runner profile to tilt the top of the drawer front forward.

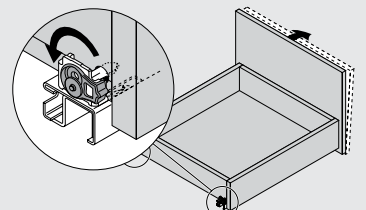

Tool free tilt adjustment +5 mm.

INST-TDM562HB.11.09

Subject to technical modifications without notice. Copyright 2009  
INDR 776.824.0 MA-191/1EN



# TANDEM plus BLUMOTION 562H Cabinet Profile Specifications

# Cabinet & Drawer Specifications

## Frame cabinet applications

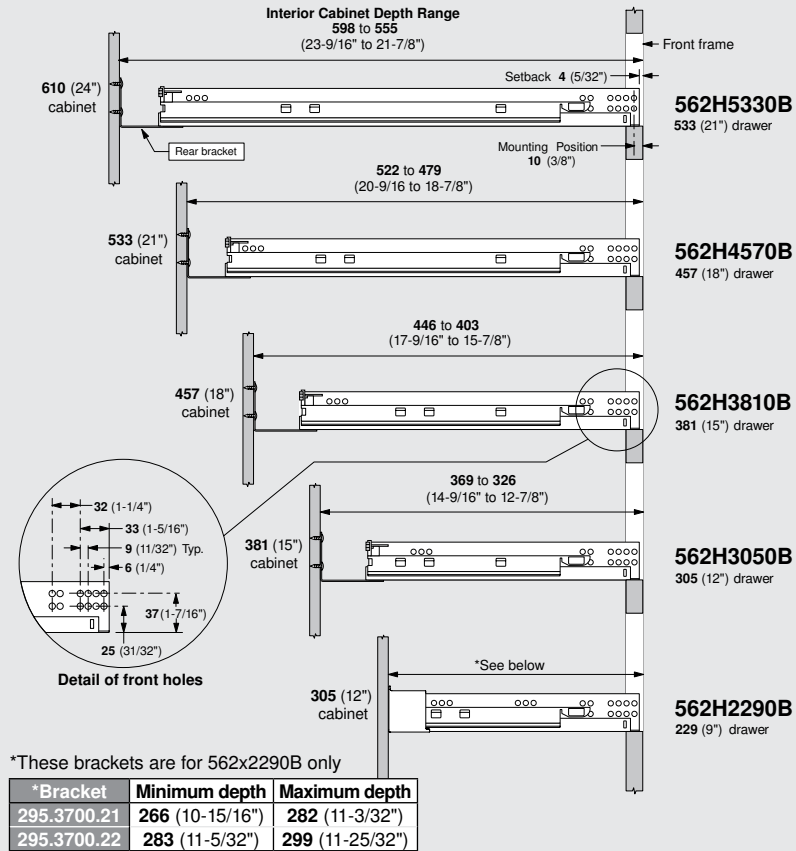

## Panel cabinet applications

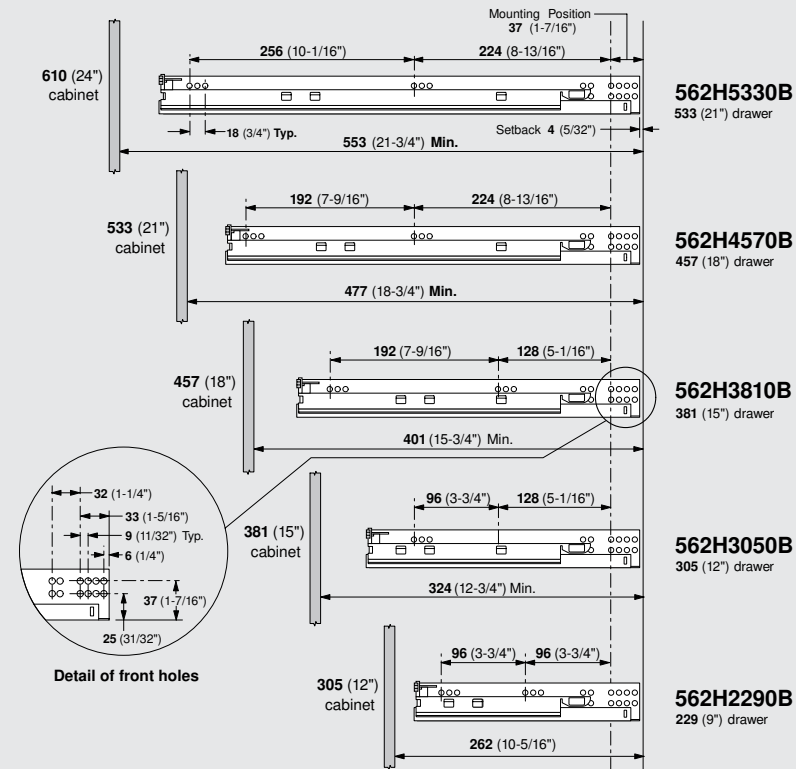

## Panel cabinet applications

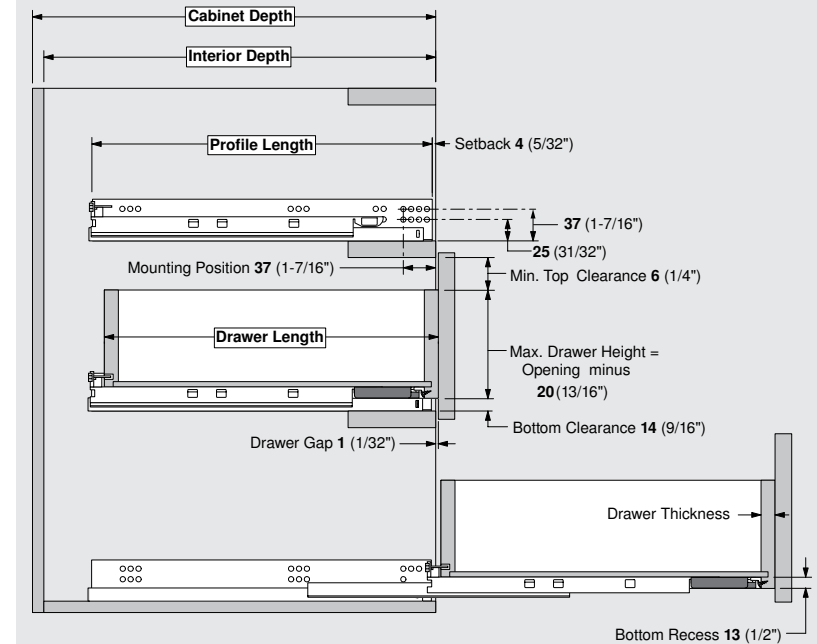

Runner	Overall Cabinet Depth	Interior Cabinet Depth Minimum	Drawer Length	Max. Drawer Thk.	Profile Length
562H5330B	610 (24")	550 (21-11/16")	533 (21")	16 (5/8")	546 (21-1/2")
562H4570B	533 (21")	474 (18-11/16")	457 (18")		470 (18-1/2")
562H3810B	457 (18")	398 (15-11/16")	381 (15")		394 (15-1/2")
562H3050B	381 (15")	321 (12-5/8")	305 (12")		317 (12-1/2")
562H2290B	305 (12")	262 (10-5/16")	229 (9")		257 (10-1/8")

## Frame inset drawer front applications

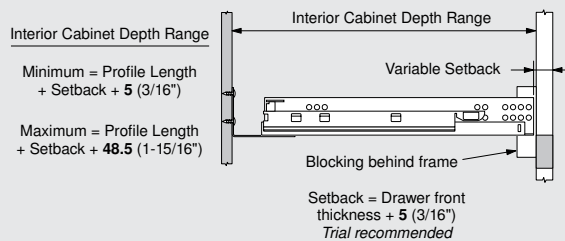

## Panel inset drawer front applications

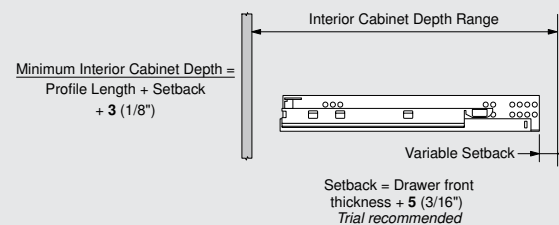

## Millimeter to inch equivalents

1	1.5	2	3	4	5	5.5	6	7	8	9	9.5	10	11	12	13	13.5	14	15	16	17	17.5	18	19	20	20.5	21	22	23	24	24.5	254
1/32	1/16	3/32	1/8	5/32	3/16	7/32	1/4	9/32	5/16	11/32	3/8	13/32	7/16	15/32	1/2	17/32	9/16	19/32	5/8	21/32	11/16	23/32	3/4	25/32	13/16	27/32	7/8	29/32	15/16	31/32	1

T51.1700.04R Locking device (right)  
T51.1700.04L Locking device (left)

612TH Installation screw (for locking devices)  
707N Installation screw (for mounting runner to cabinet side)

All dimensions in millimeters. (Inch equivalents as noted)

Subject to technical modifications without notice. Copyright 2009

