

Product details

LEGRABOX pure with BLUMOTION/for TIP-ON BLUMOTION, drawer, height K (128.5 mm), 40 kg, NL=450 mm

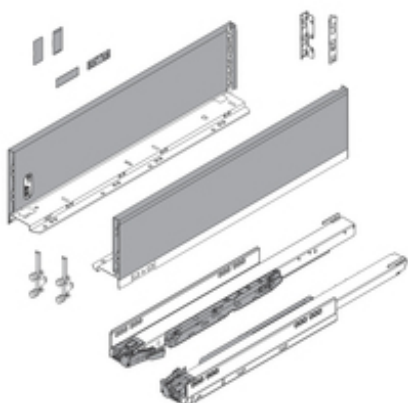

Part number	770K45S0S
Item number	02722655
Color / finish	Orion gray matte
Packaging quantity	1
Weight per 1,000 Pcs in kg	4,482.16
EAN code	9009494506686
UPC code	

Technical attributes

Attribute	Value
nominal length	450
Height of Drawer Side	K (128.5 mm)
dynamic load capacity	40
Drawer type	full ext.
type of BOX	LEGRABOX drawer profile
design	plain
material	Steel
finish of drawer side	Orion gray matte
type of front attachment	Front fixing bracket
connecting front fixing bracket to front	EXPANDO
type of back/back attachment	Rear fixing bracket
height	98.6
packaging	Commercial packing
item package	Set