

Drawer adjustments

METABOX series (See inside for adjustments.)

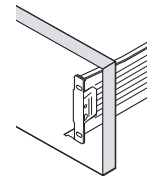

Clip on

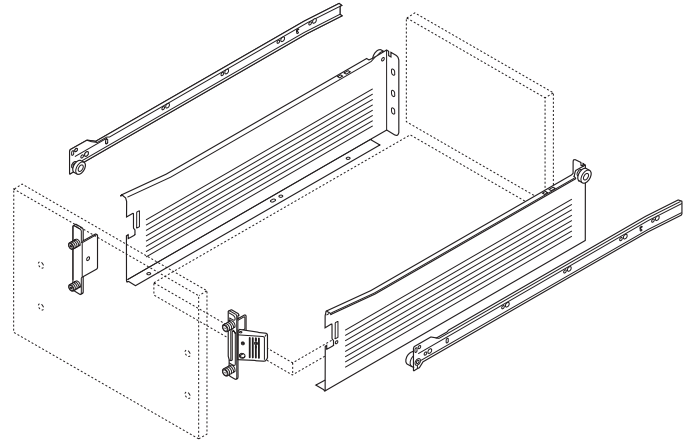
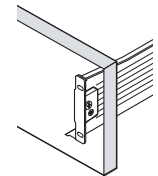

screw on

Blum, Inc.
7733 Old Plank Rd.
Stanley, NC 28164
toll free 800-438-6788
local 704-827-1345
fax 704-827-0799
internet www.blum.us

Side adjustment

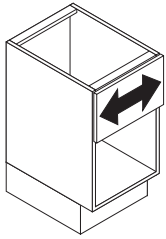

1. Loosen 2 screws on each bracket that attach front.
 2. Adjust drawer front.
 3. Tighten screws.
- Range = 1/8" (3mm)**

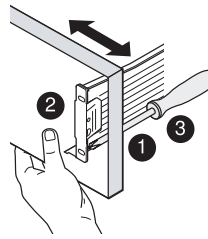

Height adjustment

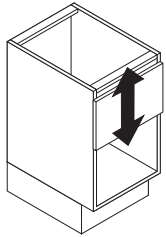

Height Up:
Rotate adj. cam.

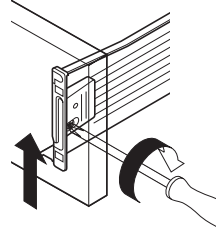

- Height Down:
1. Back off height adj. cam
 2. Open cover with POZI driver and push drawer front down, close cover.
 3. Rotate cam to bring drawer front up into position.

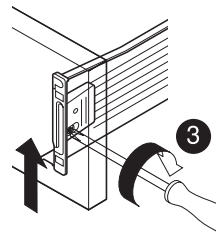
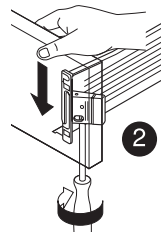
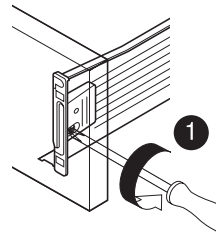

Side adjustment

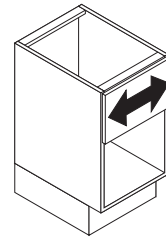

1. Loosen 2 screws on each bracket that attach front.
 2. Adjust drawer front.
 3. Tighten screws.
- Range = 1/8" (3mm)**

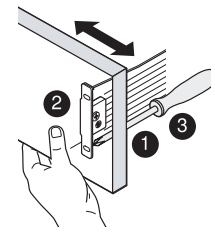

Height adjustment

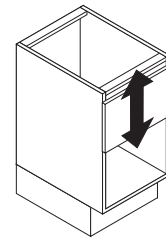

1. Loosen top fixing screw on bracket.
 2. Turn bottom cam screw to adjust height.
 3. Tighten fixing screw.
- Range = 5/32" (4mm)**

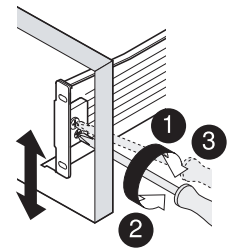

Tilt adjustment

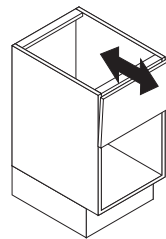

For taller drawer with gallery rails.

Turning the rails by hand extends or reduces their length which tilts the drawer front.

