

MOVENTO

Assembly Aids & Tools

Universal individual template



- Used to pre-bore holes for MOVENTO and TANDEM runners
- Also used for making/pre-boring other Blum drawer systems, AVENTOS locating pins, hinge mounting plates, BLUMOTION adapters, and TIP-ON adapters
- Calibrated scale for accurate setting

Set includes:

- Universal individual template
- Ø2.5 and Ø5 stop collars
- Allen wrench

Part no.

Universal individual template

65.1051.02

Cabinet profile template set



- Used to pre-bore holes for MOVENTO and TANDEM runners
- Also used for making/pre-boring other Blum drawer systems, AVENTOS locating pins, hinge mounting plates

Set includes:

- Rail, 1 meter long
- Replacement template (qty 4)
- Ø2.5 and Ø5 stop collars
- Allen wrench

Part no.

Cabinet profile template

65.1000.01

Replacement template

65.1001.01

Ø2.5 drill bit

DB-2.5mm

Ø5 drill bit

DB-5mm

Concealed runner template

- Essential tool for drawers using any series MOVENTO or TANDEM runners
- To bore the Ø6 holes for rear hooks
- Pre-bore Ø2.5 hole for MOVENTO locking devices at the required angle

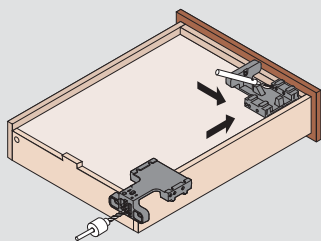

Part no.

Template

T65.1600.01

Accessories (order separately)

Ø2.5 drill bit

DB-2.5mm

Ø6 drill bit

DB-6mm

Tool set

T65.9000

Using the Concealed runner template

1 Bore rear hook holes

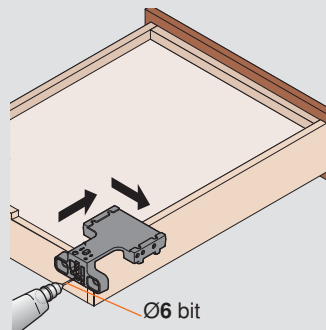

2 Pre-bore holes for locking device screws

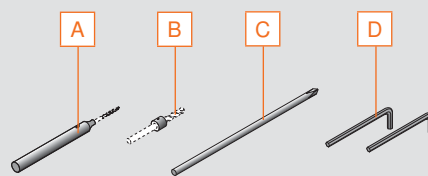
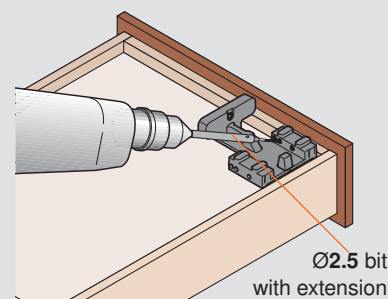

Tool set includes:

- A Ø2.5 drill bit extension
- B Ø6 stop collar
- C #2 Phillips screwdriver tip
- D Allen wrenches

NOTE: Items NOT sold separately

Assembly Aids & Tools

MOVENTO



Deep thread system screw

- Pilot bore Ø5 (3/16") hole

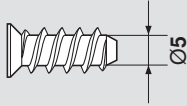

Part no.

#6 x 11.5, #2 POZI

662.1150.HG

Deep thread wood screw

- Pilot bore Ø2.5 (3/32") hole

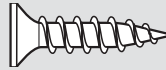

Part no.

#6 x 5/8", #2 Phillips

606N

#6 x 5/8", #2 POZI

606P

#6 x 3/4", #2 Phillips

6064N

Truss head wood screw

- Pilot bore Ø2.5 (3/32") hole

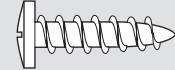

Part no.

#6 x 1/2", #2 Phillips

612TH

Helpful Tools



> EASY ASSEMBLY App

Have questions when installing products?

The new EASY ASSEMBLY App makes assembling and installing Blum products easy. Created to be a helpful reference tool, this app uses up-to-date instruction sheets and videos to clearly show step by step directions for every product. Whether you are in the cabinet shop or on the jobsite, the Easy Assembly App is at your fingertips whenever you need it.

Available for iOS and Android



> Download now:
www.blum.com/easy-assembly-app

> Connect With Us on Social Media

Be sure to connect with us on social media for additional resources for information regarding tips on installation, maximizing storage space, new products and other news and events going on inside Blum.

Find us by searching "**Blum Inc**" in the search bar.



> Online Resource for Planning

Easy Planning

Blum offers many online tools to help you with your kitchen planning and ordering. Online Product Configurator (OPC) offers a parts list and planning information based on your specifications. Once complete, your results can then be exported to a shareable document.

OPC is easily accessible on our website at blum.com/configurator

