

CLIP top BLUMOTION

Three-dimensional adjustment

Side adjustment

Rotate front screw to increase or decrease door overlay (± 2 mm).

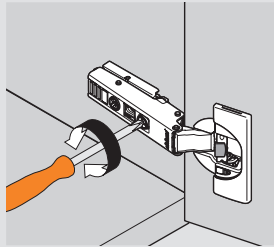
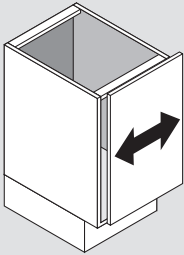

Height adjustment

Rotate cam screw on mounting plate to adjust door position (± 2 mm).

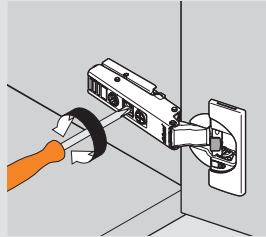
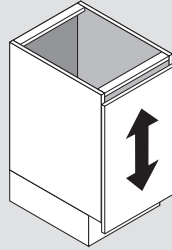

On non-cam mounting plates, loosen screws, adjust door and retighten screws.

Depth adjustment

Rotate rear spiral tech cam screw to adjust door gap ($+3$ mm, -2 mm).

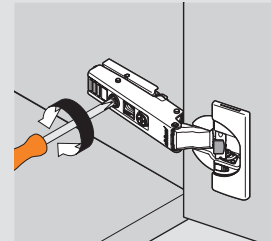
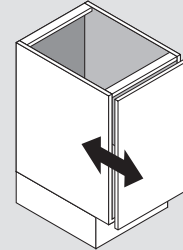

BLUMOTION deactivation

Switch on hinge cup

For small or light doors, the BLUMOTION can be deactivated on one of the hinges.

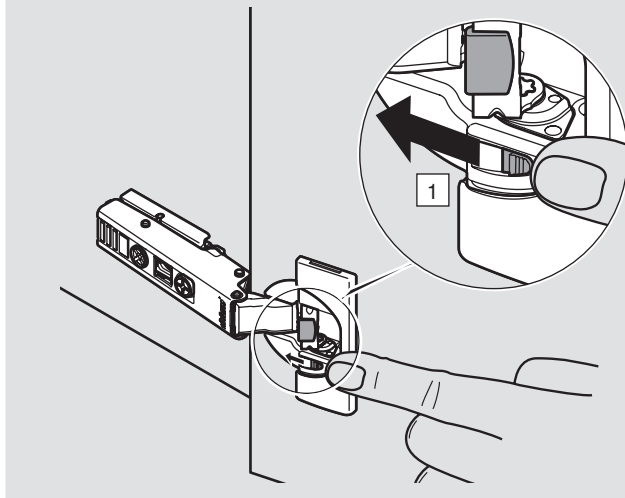

Door must be closed once for the deactivation to be complete. To reactivate, move switch back to original position.

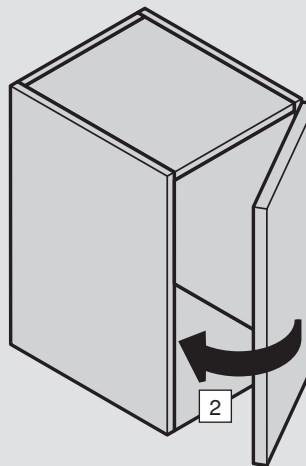

Blum, Inc.
800-438-6788
www.blum.com

Subject to technical modifications without notice. © 2010
LIT.HNG5100.08.10

 **blum**[®]