

8K SERIES

Heavy Duty Locks-Knobs

STANLEY[®]
Security Solutions

| TABLE OF CONTENTS | | Page | Page |
|-------------------------|---|-------------------------------------|------|
| Features..... | 2 | Special Features | 5 |
| Certification..... | 2 | Functions | 6-9 |
| Patents..... | 2 | CORMAX™ Patented Keying System..... | 10 |
| Specifications..... | 3 | Deadlocking Latches & Strikes | 10 |
| How To Order | 3 | Door Preparation..... | 11 |
| Shipping Weights..... | 3 | Sample Specifications | 11 |
| Knob Styles & Trim..... | 4 | Service Equipment..... | 12 |

FEATURES

- Quick, economical rekeying with the BEST® interchangeable core.
 - Knobs machined from brass or bronze bar stock.*
 - Rotating knob face provides for easy hand of door change without removing the knob.
 - No keeper hole on keyed knobs for added security.
 - Keyed knob removable only after the core is removed.
 - The tactile or knurled knob feature designed for blind, safety and accessibility applications.
 - Friction insert inside rose resists loosening.
 - The optional breakaway feature prevents the lockset from being overpowered by a wrench.
 - 3/16" throw, deadlocking latch.
 - Spin free knob feature permits the lock to be operated only by use of a key.
 - Steel retractor with low friction bearings for smooth, wear resistant operation.
 - Long bearing length in chassis for smooth, wear resistant operation.
- * All knob styles feature solid extruded knob material.

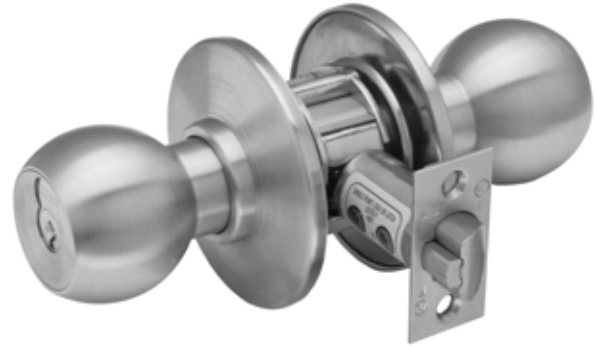

8K Heavy Duty Cylindrical

Products covered by one or more of the following patents:
 5,590,555 5,794,472

CERTIFICATION

- The 8K Cylindrical Lock meets or exceeds the following standards:
- Builders Hardware Manufacturers Association: 8K series – Listed by BHMA for A156.2, Series 4000, Grade 1.
 - Underwriters Laboratories®: 8K series – Listed by Underwriters Laboratories for use on 3 Hr, A label for single or double swinging doors.
 - California State Fire Marshal: 8K series – Listed with California State Fire Marshal.



Materials: Internal parts are brass or corrosion-treated steel.

Chassis: 2 1/8" diameter to fit 2 1/8" hole in door.

Backset: 2 3/4" standard, 3 3/4" and 5" available.

Latch: 9/16" throw. Front 2 1/4 x 1 1/8" beveled. Latch housing fits 1" hole in edge of door.

Knobs: Diameter– 2 1/8" ; Projection from door– 2 7/8" #4, #6 Knob Material - Machined from solid brass or bronze.

Roses: All roses are brass or bronze reinforced with steel liner. Roses are threaded to chassis. "A"– round, 3 3/8" diameter; "C"– round, 2 9/16" diameter; "D"– convex round, 3 3/8" diameter "E"– special trim for 2 1/8" to 3" thick doors

Door Thickness: Adjustable from 1 3/8" to 2" standard. Special "E" trim for 2 1/8" to 3" doors available. The "B" style square trim is for doors 1 3/4" to 2" only.

Strike:

(STK) – 2 3/4" x 1 1/8" with curved lip and box standard (ANSI A115.3)

(S3) – 4 7/8" x 1 1/4" with curved lip and box available (ANSI A115.2)

(S3-7/8) – Conforms to ANSI A115.2 for 1 3/4" doors.(4 7/8" x 1 7/8" flat)

Latch & Strike Screws:

(STK) **Strike Package** – (1) 2 3/4" Strike plate, (4) #8-32 / #8-16 x 3/4" Phillips flat head screws.

8KS3 Strike Package –(1) 4 7/8" Strike plate, (2) #8-32 / #8-16 x 3/4" Phillips flat head screws, (2) #12-24 / #12-12 x 3/4" Phillips flat head screws. Security head machine screws and driver can be ordered for added security.

Finish: 605– bright brass, clear coated; 606– satin brass, clear coated; 611– bright bronze, clear coated; 612– satin bronze, clear coated; 613– oxidized satin bronze, oil rubbed; 625– bright chromium plated; 626– satin chromium plated; 690– dark bronze coated

HOW TO ORDER

| 8K | 3 | 7 | AB | 4 | A | STK | 626 | |
|--------|------------------------------------|--|---|--|--|---|---|---|
| Series | Backset | Core Housing | Function Code | Knob Style | Rose Style | Strike Package | Finishes | Options |
| 8K | 3 – 2 3/4" 4 – 3 3/4" 5 – 5" | 0– keyless 7– 7-pin housing accepts all BEST® cores see pages 8–11 | AB– entrance D– storeroom L– privacy N– passage R– classroom etc. see page 3 | 4– round 6– tulip see page 3 | A– 3 3/8" C– 2 9/16" D– convex E– thick (not shown) see page 5 | STK– standard S3– ANSI S3– 7/8" flat strike | 605 606 611 612 613 625 626 690 split finish is available | BRK – breakaway (#4, #6) KNL – knurled (#6 knob) LL – lead lined SH – security head screws SPN– spin free (D&W function)(#4, #6 knobs) TAC – tactile knob (#4, #6) Note: specify inside (I), outside (O), or both (B) for KNL, TAC options 3/4 – 3/4" throw latch see page 4 |

** Must specify key mark and number of keys or designate L/C for less core.

8KS2 Strike (Standard)

SHIPPING WEIGHTS

The chart below gives the approximate shipping weight for standard functions of 8K lockset. This weight includes the weight of the lockset with the #4 style knob, "A" style rose, latch, strike package, and box. Listed separately are the approximate weights for "with core" and "less core" shipments.

| Lock Function Nomenclature | Case Quantity | Shipping Weight With core | Shipping Weight Less Core |
|----------------------------|---------------|---------------------------|---------------------------|
| Y | 12 | 36 lbs | 36 lbs. |
| N | 12 | 44 lbs. | 44 lbs. |
| L,P | 12 | 47 lbs. | 47 lbs. |
| AB,D,E,H,HJ,R,T | 12 | 49 lbs. | 47 lbs. |
| C,G,S,W | 12 | 55 lbs. | 51 lbs. |

KNOB STYLES & TRIM



Knob-4 Rose-A



Knob-4 Rose-C



Knob-4 Rose-D



Knob-6 Rose-A



Knob-6 Rose-C



Knob-6 Rose-D

SPECIAL FEATURES



Breakaway Feature

When excessive force (approx. 300 inch lbs.) is applied to #4, #6 keyed knobs, they “breakaway” and spin freely, thus allowing entrance only by key. Simple part replacement returns lock to functional usage.

To order: Designate “BRK” on options of “How to Order” (page 5).

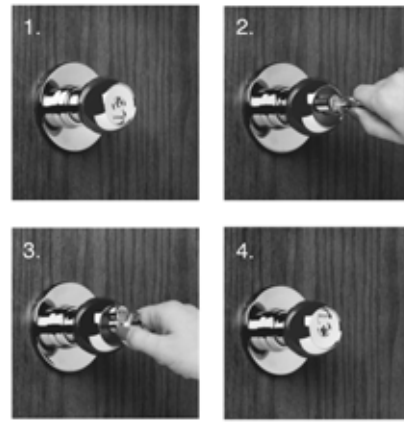

Reversible Knob Face

1. Core is upside down (wrong side)
2. Partially remove core with Control Key.
3. Rotate knob face 180 degrees.
4. Reinsert core with “BEST” in up position.

The lockset is easily reversible for either hand of the door without removing the keyed knob.



Knurled Feature

This feature is available only on #6 knob only. The knurling is machined into the outer edge of the knob. The knurled feature can be used for blind, safety or accessibility applications.

To order: Designate “KNL” on options of “How to Order” (page 5).



Spin Free Feature

This unique feature is for #4, #6 knobs and is standard on H and HJ functions and optional on D and W. The spin free feature allows the outside knob to spin freely at all times while the core and knob face remain stationary, thus permitting the lock to be operated only by use of a key.

To order: Designate “SPN” on options of “How to Order” (page 5).



Lead Lined Feature

Lead lined can be used to protect against X-rays. Since the majority of lead lined doors contain the lead in the surface of the door, the 8K lockset provides lead lining for the holes cut in the door when preparing the door for the trim. A 3/16” lead slug is installed in the knob face.

To order: Designate “LL” on options of “How to Order” (page 5).







Tactile Feature

Grooves are machined into the #4 and #6 solid brass or bronze knobs, to improve grip, or can be used as a warning in hazardous areas. This option can be used for blind, safety or accessibility applications.

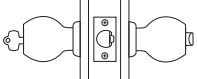
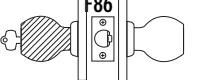
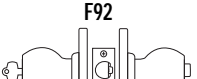
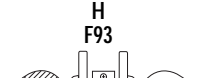

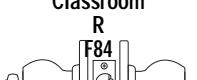

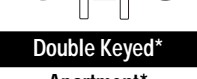
To order: Designate “TAC” on options of “How to Order” (page 5).

FUNCTIONS

| Function & Diag. (ANSI No.) | Description | Outside Lever | | Inside Lever | |
|--|--|---|--|--|--|
| | | Latch operated by | Locked by | Unlocked by | Locked by |
| Single Keyed | | | | | |
| Entrance AB F109(F81x F82)  | <ul style="list-style-type: none"> Rotating the inside knob, Rotating the outside knob only when the inside push button is out Turning the outside key | <ul style="list-style-type: none"> Pushing the inside button, Pushing and turning the inside button (Turning the button keeps the outside knob locked until button is turned back and released) | <ul style="list-style-type: none"> Turning the key in the outside knob, Rotating the inside knob, Closing the door- (only when the button is not turned, this applies for each operation) | Cannot be locked | Always unlocked |
| Storeroom D F86  | <ul style="list-style-type: none"> Turning the key in the outside knob, Rotating the inside knob | Always locked | Cannot be unlocked | Cannot be locked | Always unlocked |
| Service Station E F92  | <ul style="list-style-type: none"> Rotating the inside knob, Rotating the outside knob only when the inside slotted push button is out Turning the key in the outside until button is turned back knob | <ul style="list-style-type: none"> Pushing the inside button, Pushing and turning the inside slotted button (Turning the button keeps the outside knob locked until button is turned back and released) | <ul style="list-style-type: none"> Turning the key in the outside knob, Rotating the inside knob, Closing the door-(only when the button is not turned, this applies for each operation) | Cannot be locked | Always unlocked |
| Hotel Guest Room H F93  | <ul style="list-style-type: none"> Rotating the inside knob, Turning the key in the outside knob- only when the inside push button is out, Removing the core with a control key and using a special emergency key | Always locked | <ul style="list-style-type: none"> Key block feature is released by: Rotating the inside knob, Closing the door Removing the core with a control key and using a special emergency key | Cannot be locked | Always unlocked |
| NOTE: Pushing the inside button projects an "occupied" indicator in the outside knob and blocks all operating keys. | | | | | |
| Hotel Guest Room HJ  | <ul style="list-style-type: none"> Rotating the inside knob, Turning the key in the outside knob-only when the inside push button is out, Removing the core with a control key and using a special emergency key | Always locked | <ul style="list-style-type: none"> Key block feature is released by: Rotating the inside knob, Closing the door | Cannot be locked | Always unlocked |
| NOTE: Pushing the inside button blocks all operating keys, but no "occupied" indicator is projected. | | | | | |
| Classroom R F84  | <ul style="list-style-type: none"> Rotating the inside knob, Turning the key in the outside knob, Rotating the outside knob when not locked by key | <ul style="list-style-type: none"> Turning the key in the outside knob | <ul style="list-style-type: none"> Turning the key in the outside knob | Cannot be locked | Always unlocked |
| Dormitory T F90  | <ul style="list-style-type: none"> Rotating the inside knob, Rotating the outside knob when not locked by key or push button | <ul style="list-style-type: none"> Turning the key in the outside knob, Pushing the button on the inside knob | <ul style="list-style-type: none"> Turning the key in the outside knob, Rotating the inside knob (only when locked by push button), Closing the door (only when locked by push button) | Cannot be locked | Always unlocked |
| Double Keyed* | | | | | |
| Apartment* C F88  | <ul style="list-style-type: none"> Rotating the inside knob, Rotating the outside knob when not locked by inside key, Turning the key in the outside knob | Turning the key in the inside knob | Turning the key in the inside knob | Cannot be locked | Always unlocked |
| Store lock* G F91  | <ul style="list-style-type: none"> Rotating the outside knob when not locked by key Rotating the inside knob when not locked by key | <ul style="list-style-type: none"> Turning the key in the inside knob, Turning the key in the outside knob | <ul style="list-style-type: none"> Turning the key in the inside knob, Turning the key in the outside knob | <ul style="list-style-type: none"> Turning the key in the inside knob, Turning the key in the outside knob | <ul style="list-style-type: none"> Turning the key in the inside knob, Turning the key in the outside knob |
| NOTE: Turning the key in either the inside OR the outside, locks or unlocks both sides | | | | | |

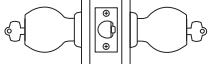
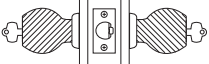
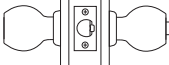
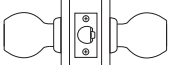
*ATTENTION: Locksets that secure both sides of the door are controlled by building codes and the Life Safety Code. In an emergency exit situation, failure to quickly unlock the inside knob could be hazardous or even fatal.

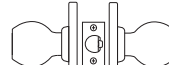
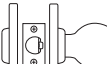
FUNCTIONS

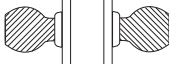
| Function & Diag. (ANSI No.) | Description | Outside Lever | | Inside Lever | |
|---|--|---|---|------------------------------------|------------------------------------|
| | | Latched by | Locked by | Unlocked by | Locked by |
| Communicating * S F80  | <ul style="list-style-type: none"> Turning the key in the inside knob, Turning the key in the outside knob, Rotating the inside or outside knob (if unlocked) | Turning the key in the outside knob | Turning the key in the outside knob | Turning the key in the inside knob | Turning the key in the inside knob |
| NOTE: Turning the key in either knob, locks or unlocks its own knob independently. | | | | | |
| Institutional * W F87  | <ul style="list-style-type: none"> Turning the key in the inside knob, Turning the key in the outside knob | Always locked | Cannot be unlocked | Always locked | Cannot be unlocked |
| Keyless | | | | | |
| Privacy L F76  | <ul style="list-style-type: none"> Rotating the inside knob, Rotating the outside knob only when the inside push button is out | Pushing the inside button | <ul style="list-style-type: none"> Rotating the outside slotted button, Rotating the inside knob, Closing the door | Cannot be locked | Always unlocked |
| Passage N F75  | <ul style="list-style-type: none"> Rotating the inside knob, Rotating the outside knob | Cannot be unlocked | Always unlocked | Cannot be locked | Always unlocked |
| Exit NX F89  | Turning the inside knob | Always locked | Cannot be unlocked | Cannot be locked | Always unlocked |
| Patio P F77  | <ul style="list-style-type: none"> Rotating the inside knob, Rotating the outside knob- only when the inside push button is out | <ul style="list-style-type: none"> Pushing the inside button Closing the door | Rotating the inside knob | Cannot be locked | Always unlocked |
| Exit Y  | Rotating the inside knob | | Cannot be locked | Always Unlocked | |
| Single Dummy Trim 1DT  | This is a single, surface-mounted knob for an inactive door or a non-latching door | | | | |
| Double Dummy Trim 2DT  | This is a through-bolt mounted pair of matching knobs for an inactive door or a non-latching door | | | | |

*ATTENTION: Locksets that secure both sides of the door are controlled by building codes and the Life Safety Code. In an emergency exit situation, failure to quickly unlock the inside knob could be hazardous or even fatal.

SPECIAL FUNCTIONS

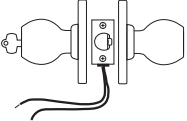
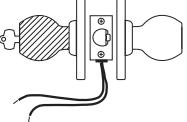
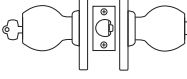
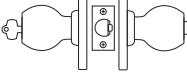
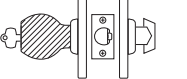
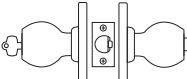
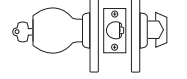
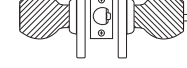
| Function & Diag. (ANSI No.) | Description | Outside Lever | | Inside Lever | |
|---|---|---|--|-----------------------------------|----------------------------------|
| | | Latch operated by | Locked by | Unlocked by | Locked by |
| Electrified | | | | | |
| Electrically Locked DEL  | <ul style="list-style-type: none"> Rotating the inside knob, Rotating the outside knob only when power is off, Turning the key in the outside knob | Applying 24 Volts DC; the outside knob remains locked only while power is on | Switching off 24 Volts DC | Cannot be locked | Always unlocked |
| NOTE: Locks are powered by 24 Volts DC and 0.18 Amps, continuous duty. | | | | | |
| Electrically Unlocked DEU  | <ul style="list-style-type: none"> Rotating the inside knob, Rotating the outside knob only when power is on, Turning the key in the outside knob | Switching off 24 Volts DC | Applying 24 Volts DC; the outside knob remains unlocked only while power is on | Cannot be locked | Always unlocked |
| NOTE: Locks are powered by 24 Volts DC and 0.18 Amps, continuous duty. | | | | | |
| Special functions | | | | | |
| Dormitory or Storeroom A F81  | <ul style="list-style-type: none"> Rotating the inside knob, Rotating the outside knob only when inside turn button is in unlocked position, Turning the key in the outside knob | Turning the inside button | Turning the inside button | Cannot be locked | Always unlocked |
| NOTE: Turn button must be manually rotated to unlock the outside knob. | | | | | |
| Office B F82  | <ul style="list-style-type: none"> Rotating the inside knob, Rotating the outside knob only when inside push button is out, Turning the key in the outside knob | <ul style="list-style-type: none"> Pushing the inside button outside knob, Rotating the inside knob | Turning the key in the | Cannot be locked | Always unlocked |
| NOTE: Push button is released by turning the key in the outside knob, OR rotating the inside knob. Closing the door does not release the push button. | | | | | |
| Closet or Storeroom DZ  | <ul style="list-style-type: none"> Turning the key in the outside knob, Turning the inside closet turn knob | Always locked | Cannot be unlocked | Closet turn knob cannot be locked | Closet turn knob always unlocked |
| Entrance or Office EA  | <ul style="list-style-type: none"> Rotating the inside knob, Rotating the outside knob only when inside push button is out, Turning the key in the outside knob | <ul style="list-style-type: none"> Pushing inside button, Pushing and turning the inside button (Turning slotted button keeps the outside knob locked until the button is turned back | <ul style="list-style-type: none"> Turning the key in the outside knob*, Rotating the inside knob*, Closing the door* | Cannot be locked | Always unlocked |
| *Only when slotted button depressed and not turned. | | | | | |
| Closet or Storeroom RZ  | <ul style="list-style-type: none"> Turning the key in the outside knob, Turning the inside closet turn knob, Turning the outside knob when unlocked by key | Turning the key in the outside knob | Turning the key in the outside knob | Closet turn knob cannot be locked | Closet turn knob always unlocked |
| Special* XD  | <ul style="list-style-type: none"> Turning the key in the inside knob | Always locked | Cannot be unlocked | Always locked | Cannot be unlocked |

*ATTENTION: Locksets that secure both sides of the door are controlled by building codes and the Life Safety Code. In an emergency exit situation, failure to quickly unlock the inside knob could be hazardous or even fatal.

SPECIAL FUNCTIONS

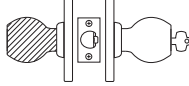
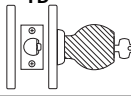
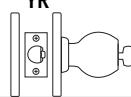
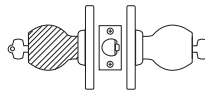
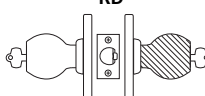
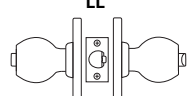
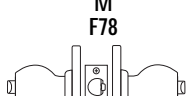
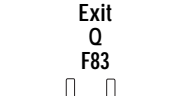
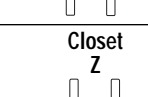
| Function & Diag. (ANSI No.) | Description | Outside Lever | | Inside Lever | |
|--|---|-------------------------------------|---|------------------------------------|-------------------------------------|
| | | Latched by | Locked by | Unlocked by | Locked by |
| Special functions | | | | | |
| Special* XR  | <ul style="list-style-type: none"> Turning the key in the inside knob, Rotating the inside knob when not locked by key | Always locked | Cannot be unlocked | Turning the key in the inside knob | Turning the key in the inside knob |
| Exit* YD  | <ul style="list-style-type: none"> Turning the key in the inside knob | N/A | N/A | Always unlocked | Cannot be unlocked |
| Special* YR  | <ul style="list-style-type: none"> Turning the key in the inside knob, Rotating the inside knob when not locked by key | N/A | N/A | Turning the key in the inside knob | Turning the key in the inside knob |
| Special * DR  | <ul style="list-style-type: none"> Rotating the inside knob when unlocked by inside key, Turning the key in the outside knob, Turning the key in the inside knob | Always locked | Cannot be unlocked | Turning the key in the inside knob | Turning the key in the inside knob |
| Special * RD  | <ul style="list-style-type: none"> Rotating the outside knob Turning the key in the outside knob, Turning the key in the inside knob | Turning the key in the outside knob | Turning the key in the outside knob | Always locked | Cannot be unlocked |
| Hospital Privacy LL  | <ul style="list-style-type: none"> Rotating the inside knob, Rotating the outside knob only when the inside push button is out | Pushing the inside push button | <ul style="list-style-type: none"> Turning the turn button in the outside knob, Rotating the inside knob, Closing the door | Cannot be locked | Always unlocked |
| Communicating* M F78  | <ul style="list-style-type: none"> Rotating the inside knob only when the outside turn button is in the unlocked position, Rotating the outside knob only when inside turn button is in the unlocked position | Turning the inside turn button | Turning the inside turn button | Turning the outside turn button | Turning the outside turn button |
| NOTE: Do not use this function for rooms that have no other entrance. | | | | | |
| Exit Q F83  | <ul style="list-style-type: none"> Rotating the inside knob, Rotating the outside knob only when the inside turn button is in the unlocked position | Turning the inside turn button | Turning the inside turn button | Cannot be locked | Always unlocked |
| Closet Z  | <ul style="list-style-type: none"> Rotating the outside knob, Turning the inside closet turn knob | Cannot be locked | Always unlocked | Closet turn knob cannot be locked | Closet turn knob is always unlocked |

*ATTENTION: Locksets that secure both sides of the door are controlled by building codes and the Life Safety Code. In an emergency exit situation, failure to quickly unlock the inside knob could be hazardous or even fatal.

CORMAX™ PATENTED KEYING SYSTEM

BEST® CORMAX™ is the premier patented keying system offered by Stanley Security Solutions. CORMAX will meet your needs for security, key control, and convenience. A simple solution with no compromising allowed.

CORMAX is the upgrade path for existing BEST Standard, Premium, and MX8 customers; and it is an essential element of non-residential access control as security administrators strive to eliminate the unauthorized duplication of keys.



**CORMAX™
Patented Keying System**

CORMAX offers the following features and benefits:

- A long-term US utility patent that guarantees the extended useful life of the system through 2027.
- A second, independent locking mechanism that utilizes a patented set of built-in side pins to provide higher security.
- Several levels of geographical exclusivity, including national exclusivity, are available via the patented side pin feature.
- CORMAX cores and keys are available exclusively through Stanley sales offices. Key blanks are only sold to individuals authorized by the customer to ensure key blanks do not end up in the possession of unauthorized personnel either inside or outside the customer's facility.
- CORMAX cores are certified to meet the security, safety, and reliability requirements of BHMA A156.5 Grade 1.
- Picking and drilling resistance options are available if higher levels of security are desired.
- Complete factory masterkeying service offered, and at no charge with purchase of BEST locksets and PHI exit devices.
- Keyways are organized in families of four keyways each, with double-milled and quad-milled key levels to facilitate the design of masterkey systems in multi-building campuses.
- BEST CORMAX cores are compatible with all existing BEST interchangeable core housings, eliminating the need for new or modified locksets.

DEADLOCKING LATCHES & STRIKES



8KL3 Deadlocking Latch

Bolt throw – 9/16"
Backset – 2 3/4"
Front – 2 1/4" x 1 1/8" beveled.
Tube – To fit 1" diameter hole in door edge.
To order: (with unit) designate "8K3" on how to order (page 3).
To order: (without unit) designate "8KL3-SL" (Spring Latch) or DL (Deadlocking Latch) and finish.



8KL4 Deadlocking Latch

Bolt throw – 9/16"
Backset – 3 3/4"
Front– 2 1/4" x 1 1/8" beveled.
Tube – To fit 1" diameter hole in door edge.
To order: (with unit) designate "8K4" on how to order (page 3).
To order: (without unit) designate "8KL4-SL" (Spring Latch) or DL (Deadlocking Latch) and finish.



8KL5 Deadlocking Latch

Bolt throw – 9/16"
Backset – 5"
Front– 2 1/4" x 1 1/8" beveled.
Tube – To fit 1" diameter hole in door edge.
To order: (with unit) designate "8K5" on how to order (page 3).
To order: (without unit) designate "8KL5-SL" (Spring Latch) or DL (Deadlocking Latch) and finish.



8KS3-7/8 Flat Strike

Dimension: Conforms to ANSI A115.2 for 1 3/4" doors (4 7/8" x 1 7/8" flat)
To order: (with unit) designate "S3-7/8" on .. how to order (page 3).
To order: (without unit) designate 8KS3-7/8 and finish.



8KS3 Strike

Dimension: Conforms to ANSI A115.2 for 1 3/4" doors (4 7/8" x 1 1/8" with curved lip).
To order: (with unit) designate "S3" on how to order (page 3).
To order: (without unit) designate 8KS3 and .. finish.



8KS2 Strike (Supplied Standard)

Dimension: Conforms to ANSI A115.2 for 1 3/8" doors (2 3/4" x 1 1/8" with curved lip and box).
To order: (with unit) designate "STK" on how to order (page 3).
To order: (without unit) designate 8KS2 and finish.

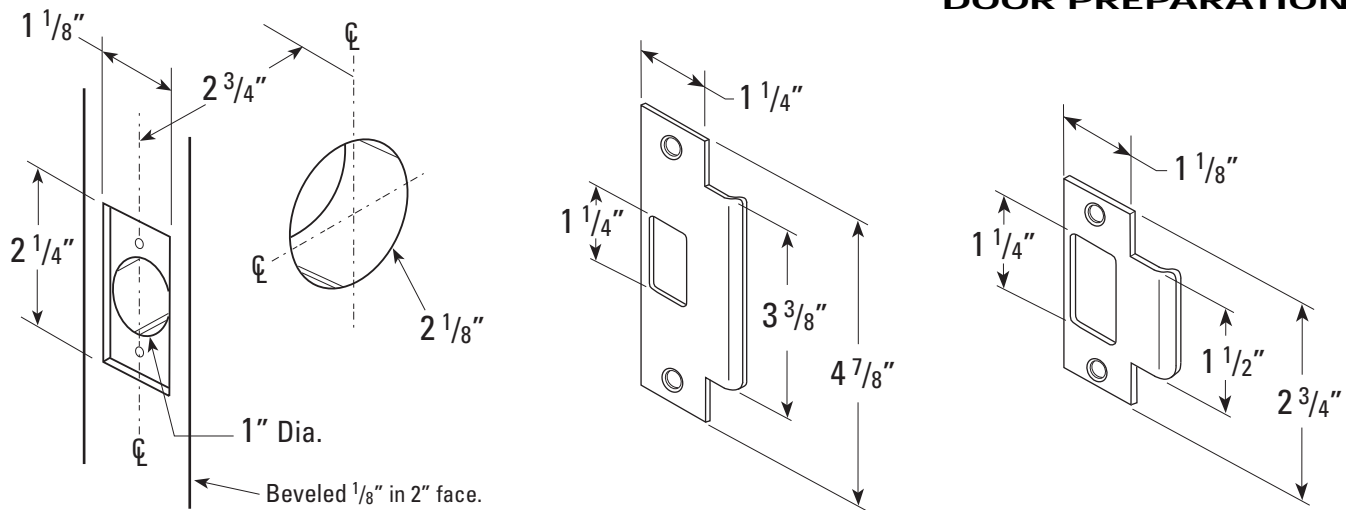

DOOR PREPARATION

SAMPLE SPECIFICATIONS – ACCEPTABLE MANUFACTURERS

A. Locksets and Latchsets

Stanley/Best - No Substitution.

1. Locksets must be extra heavy-duty cylindrical type with $2\frac{3}{4}$ inch backset, or greater as specified, with a $\frac{9}{16}$ inch throw latchbolt.
2. Provide locksets with BEST® 7-pin interchangeable core.
3. Locksets and latchsets must conform to ANSI A156.2, Series 4000, Grade 1, and be UL listed.
4. Locksets and cores to be of the same manufacturer to maintain complete lockset warranty.
5. Locksets must be available with tactile or abrasive lever for identification of hazardous areas.
6. Locks to have solid shank with no opening for access to keyed lever keeper.
7. Keyed lever to be removable only after core is removed, by authorized control key, to allow access to lever "keeper".
8. Permanent core face must be the same finish as the lockset finish.
9. Levers must have a minimum wall thickness of .060.

B. Keys and Keying

A. Provide construction cores and keys during the construction period. Construction, control and operating keys and cores shall not be part of the Owner's permanent keying system or furnished on the same keyway as the Owner's permanent keying system.

Permanent cores and keys prepared according to the accepted keying schedule will be furnished to the Owner by the local Stanley/Best office prior to occupancy. The Owner or Owner's agent will install permanent cores and return the construction cores to the Stanley/Best office.

B. All cylinders shall be Best 7-pin, interchangeable core and keyed into a [new] [existing] factory registered Grand Master Key System with a restricted keyway.

C. Permanent keys and cores shall be stamped with the applicable key mark for identification.

These visual key control marks or codes will not include the actual key cuts. Permanent keys will also be stamped ["Do Not Duplicate".] ["U.S. Gov.-Do Not Duplicate".] [_____]

D. Grand Masterkeys, Masterkeys and other Security Keys shall be transmitted to the Owner by U.P.S., delivery confirmation requested.

E. Furnish keys in the following quantities:

- | | |
|---------------------------------------|--------------------------------|
| 1 each Grand Masterkey | 2 each Construction masterkeys |
| 2 each Masterkeys per set | 2 each Control keys |
| 1 each Change key per each keyed core | |

F. Computer key and core control software Stanley/Best Keystone® 600N5 will be provided and registered to the owner by the local Stanley Security Solutions office. The owner will furnish compatible hardware to operate the key and core control program. The Stanley/Best office will provide initial training on computer key and core control as well as on-going support including software updates.

SERVICE EQUIPMENT

KD304A Boring Jig Kit

The KD304A jig kit is made for boring cut-outs in wooden doors for Fed. Spec. 160 and 161 series cylindrical/tubular locksets, doors 1 3/8" to 2 1/4" thick. The KD304A kit includes the boring jig (to drill wood doors for 2 3/8", 2 3/4", 3 3/4", and 5" backsets), a quick-release adaptor for 3/8" drill chuck, a 2 1/8" bit, and a 1" diameter x 9" bit.



KD304A parts



KD304A with case

The following kit items can also be purchased separately.

- KD309 – 2 1/8" bit
- KD318 – 1" dia. x 9" bit
- KD319 – 3/8", quick release adaptor
- To order complete kits specify: **KD304A Kit**

KD312 and KD315 Face Plate Marking Chisel and KD325 Strike Plate Location Pin

The KD315 face plate marking chisel (which locates the mortising for the faceplate) and the KD325 strike locating pin (which centers the strike for proper installation) and is used for Fed. Spec. 161 cylindrical lockset, (1 1/8" x 2 1/8"), and BEST® series 82T & 83T tubular locks. The KD312 face plate marking chisel is available for Fed. Spec. 160 (1" x 2 1/4") preparation.

To order specify:

- KD312– face plate marking chisel 1" (160)
- KD315– face plate marking chisel 1 1/8" (161)
- KD325– strike plate locating pin



KD315
(Fed. Spec. 161)



KD325

KD 316 Spanner Wrench

All 8K locksets require the use of the **KD316** spanner wrench for door mounting. This tool is included with every 10 locksets ordered. If more are needed designate quantity and **KD316** on your order.



KD316

Mortise-to-Cylindrical Lock Adaptor Kit



83KA2A

Mortise lock mounting may be converted to BEST® cylindrical lock through use of this kit.

Specifications

- Materials: Stainless steel
- Finish: 630 only
- Escutcheon: 3 1/2" x 8 1/2" x .050" thickness
- Strike: 1 1/2" x 8" with 6 3/4" lip, 1 1/4" to center
- Face Plate: 83KF1–8" x 1 1/8" wide
- Backset: 2 3/4" Door thickness is increased 7/64" for mounting 83K series locksets
- To order specify: adaptor kit **83KA2A** kit

One-Piece Universal Mortise/Cylindrical-to-Cylindrical Adaptor Kit

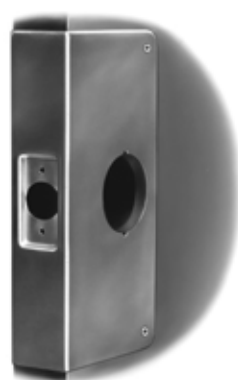

83KA2B

Door previously mounted with another manufacturer's lockset may be quickly adapted to a BEST® cylindrical lock through use of the following kit.

Specifications

- Materials: Stainless steel
- Finish: 630 only.
- Face Plate Recess: 2 1/4" x 1 1/8"
- Backset: 2 3/4"
- Door Thickness: 1 3/4"
- To order specify: **83KA2B**



Stanley Security Solutions, a business division of Stanley Black & Decker, is a provider of integrated access control and security solutions for institutional, commercial and industrial businesses and organizations. Stanley Security Solutions delivers a comprehensive suite of security products, software and integrated systems with a strong emphasis on service. Stanley Security Solutions is committed to extending its position as a leading comprehensive resource for a broad and extensive array of solutions that span the entire security spectrum.